



expertmeter™

# POWER QUALITY AND REVENUE METER EM720/EM720T

## Operation Manual

---



## LIMITED WARRANTY

The manufacturer offers the customer a 24-month functional warranty on the instrument for faulty workmanship or parts from date of dispatch from the distributor. In all cases, this warranty is valid for 36 months from the date of production. This warranty is on a return to factory basis.

The manufacturer does not accept liability for any damage caused by instrument malfunction. The manufacturer accepts no responsibility for the suitability of the instrument to the application for which it was purchased.

Failure to install, set up or operate the instrument according to the instructions herein will void the warranty.

Only a duly authorized representative of the manufacturer may open your instrument. The unit should only be opened in a fully anti-static environment. Failure to do so may damage the electronic components and will void the warranty.

The greatest care has been taken to manufacture and calibrate your instrument. However, these instructions do not cover all possible contingencies that may arise during installation, operation or maintenance, and all details and variations of this equipment are not covered by these instructions.

For additional information regarding installation, operation or maintenance of this instrument, contact the manufacturer or your local representative or distributor.

## WARNING

**Read the instructions in this manual before performing installation, and take note of the following precautions:**



**Ensure that all incoming AC power and other power sources are turned OFF before performing any work on the instrument. Failure to do so may result in serious or even fatal injury and/or equipment damage.**



**Before connecting the instrument to the power source, check the labels on the back of the instrument to ensure that your instrument is equipped with the appropriate power supply voltage, input voltages and currents.**



**Under no circumstances should the instrument be connected to a power source if it is damaged.**



**To prevent potential fire or shock hazard, do not expose the instrument to rain or moisture.**



**The secondary of an external current transformer must never be allowed to be open circuit when the primary is energized. An open circuit can cause high voltages, possibly resulting in equipment damage, fire and even serious or fatal injury. Ensure that the current transformer wiring is secured using an external strain relief to reduce mechanical strain on the screw terminals, if necessary.**



**Only qualified personnel familiar with the instrument and its associated electrical equipment must perform setup procedures.**



**Do not open the instrument under any circumstances when it is connected to a power source.**



**Do not use the instrument for primary protection functions where failure of the device can cause fire, injury or death. The instrument can only be used for secondary protection if needed.**



**Read this manual thoroughly before connecting the device to the current carrying circuits. During operation of the device, hazardous voltages are present on input terminals. Failure to observe precautions can result in serious or even fatal injury or damage to equipment.**

All trademarks are property of their respective owners

January 2011

Copyright 2008-2011 © SATEC Ltd.

# Table of Contents

<b>Chapter 1 Introduction</b> .....	<b>8</b>
<b>Chapter 2 Operating the EM720</b> .....	<b>14</b>
<b>Controls and Indicators</b> .....	<b>14</b>
<b>TEST Mode</b> .....	<b>15</b>
<b>Device Diagnostics</b> .....	<b>15</b>
<b>Meter Security</b> .....	<b>16</b>
<b>Meter Clock and Time Synchronization</b> .....	<b>17</b>
<b>Monitoring Meter Batteries</b> .....	<b>17</b>
<b>Billing and Energy Metering</b> .....	<b>18</b>
<b>Instrumentation Metering</b> .....	<b>20</b>
<b>Instrument Transformer Correction</b> .....	<b>21</b>
<b>Power Transformer/Line Loss Compensation</b> .....	<b>22</b>
<b>Operating Digital Inputs</b> .....	<b>22</b>
<b>Operating Relay Outputs</b> .....	<b>23</b>
<b>Operating the Logical Controller</b> .....	<b>24</b>
<b>Operating the Event Recorder</b> .....	<b>24</b>
<b>Operating the EN50160 Power Quality Recorder</b> .....	<b>24</b>
<b>Operating the Fast Transient Recorder</b> .....	<b>25</b>
<b>Operating the Fault Recorder</b> .....	<b>25</b>
<b>Communicating with the EM720</b> .....	<b>25</b>
<b>Auxiliary AC/DC Backup Power Supplies</b> .....	<b>29</b>
<b>Chapter 3 Using Front Display</b> .....	<b>30</b>
<b>Display Operations</b> .....	<b>30</b>
Navigation Buttons .....	30
Navigating in Data Display Mode.....	31
Status Indicators .....	32
Display Features .....	33
Measurement Units .....	34
<b>Data Displays</b> .....	<b>35</b>
TEST Mode Data Display .....	35
Billing Period Data Displays.....	35
Engineering Maximum Demand Data Display .....	39
Engineering Data Display .....	41
Setup Data Display .....	42
Device Info Display .....	42
Device Diagnostics Display.....	43
<b>Programming Mode</b> .....	<b>45</b>
Navigation Buttons .....	45
Entering Numeric Values.....	45
Password Security .....	45
Setup Menus and Access Rights.....	46
Viewing and Changing Setup Options .....	46
<b>Chapter 4 Using PAS Software</b> .....	<b>48</b>
<b>Software Installation</b> .....	<b>48</b>
Installing PAS.....	48
Installing the USB Driver .....	48
<b>Creating a New Site for your Meter</b> .....	<b>51</b>

<b>Setting up Communications</b> .....	<b>52</b>
Communicating through a Serial Port .....	52
Communicating through the Internet .....	53
Communicating through a GSM/GPRS Modem .....	54
Communicating through a USB .....	56
<b>Setting Up the Meter</b> .....	<b>57</b>
Downloading Setups to the Meter .....	58
Uploading Setups from the Meter .....	58
<b>Authorization and Security</b> .....	<b>59</b>
<b>Chapter 5 Configuring the EM720</b> .....	<b>60</b>
<b>Configuring Communications</b> .....	<b>60</b>
Setting Up Serial Communication Ports .....	60
Setting Up the Ethernet .....	62
Setting-Up Dial-Up GPRS Network .....	63
Setting-Up SNMP Client .....	64
Setting-Up eXpertPower Client .....	65
Setting-Up TCP Notification Client .....	66
<b>General Meter Setup</b> .....	<b>68</b>
Basic Meter Setup .....	68
Device Options and Mode Control .....	70
Instrument Transformer Correction Setup .....	73
Transformer/Line Loss Compensation Setup .....	74
Local Settings .....	76
Display Setup .....	80
Configuring Digital Inputs .....	82
Configuring Relay Outputs .....	84
Using Counters .....	86
Using Periodic Timers .....	87
Using Control Setpoints .....	88
<b>Configuring Billing/TOU</b> .....	<b>93</b>
Configuring Billing/Tariff Registers .....	94
Configuring the Daily Tariff Schedule .....	95
Configuring the Season Tariff and DST Schedule .....	96
<b>Configuring Recorders</b> .....	<b>98</b>
Configuring Meter Memory .....	98
Configuring the Event Recorder .....	101
Configuring the Data Recorder .....	101
Configuring the Waveform Recorder .....	106
Configuring the Fault Recorder .....	110
<b>Configuring the EN50160 Recorders</b> .....	<b>113</b>
Basic Device Settings .....	113
EN50160 Log Files .....	113
EN50160 Evaluation Limits and Options .....	114
EN50160 PQ Recorder Setup .....	114
EN50160 Harmonics Limits Setup .....	117
EN50160 Advanced Setup .....	118
Clearing EN50160 Evaluation Counters .....	119
<b>Configuring Communication Protocols</b> .....	<b>120</b>
Configuring Modbus .....	120
Configuring DNP3 .....	121
<b>Configuring Meter Passwords</b> .....	<b>127</b>
<b>Chapter 6 Device Control and Upgrading</b> .....	<b>129</b>
<b>Updating the Meter Clock</b> .....	<b>129</b>

Clearing Device Diagnostics .....	130
Resetting Accumulators and Log Files .....	130
Remote Relay Control .....	132
Operating Event Flags .....	133
Upgrading Meter Firmware .....	135
<b>Chapter 7 Monitoring Meters .....</b>	<b>137</b>
Viewing Real-time Data .....	137
Viewing Real-time Min/Max Log .....	140
Viewing Real-time Harmonic Spectrum .....	141
Viewing Real-time Waveforms .....	141
<b>Chapter 8 Retrieving and Storing Files .....</b>	<b>142</b>
Uploading Files on Demand .....	142
Using the Upload Scheduler .....	143
Retrieving EN50160 Statistics Files .....	145
Viewing Files On-line .....	146
Retrieving Waveforms On-line on Events .....	146
Exporting Files .....	146
Exporting Files in COMTRADE and PQDIF Formats .....	146
Exporting Files in Excel Format .....	148
Archiving Files .....	149
<b>Chapter 9 Viewing Files and Reports .....</b>	<b>150</b>
Operations with Files .....	150
Viewing Options .....	150
Customizing Views .....	150
Working with Tables .....	151
Working with Graphic Windows .....	152
Viewing the Event Log .....	155
Viewing the Power Quality Event Log .....	157
Viewing the Fault Log .....	160
Viewing the Data Log .....	162
Viewing Waveforms .....	163
Viewing a Waveform Graph .....	163
Viewing an RMS Plot .....	164
Viewing a Frequency Plot .....	165
Viewing a Spectrum Chart .....	165
Viewing a Spectrum Table .....	167
Waveform Viewing Options .....	168
Viewing Synchronized Waveforms .....	169
Viewing EN50160 Statistics Reports .....	171
Viewing the EN50160 Compliance Report .....	171
Viewing the EN50160 Online Statistics Report .....	174
Viewing the EN50160 Harmonics Survey Report .....	174
<b>Appendix A Parameters for Monitoring and Logging .....</b>	<b>175</b>
<b>Appendix B Setpoint Parameters .....</b>	<b>194</b>
<b>Appendix C Billing and Load Profile Log Files .....</b>	<b>195</b>
<b>Appendix D EN50160 Statistics Log Files .....</b>	<b>199</b>
<b>Appendix E EN50160 Evaluation and Recording .....</b>	<b>205</b>
EN50160 Background .....	205
Evaluation Techniques .....	206
Methods of Evaluation .....	207

<b>Appendix F</b>	<b>Data Scales .....</b>	<b>215</b>
<b>Appendix G</b>	<b>Device Diagnostic Codes.....</b>	<b>216</b>
<b>Appendix H</b>	<b>OBIS Identification Codes .....</b>	<b>217</b>

## Chapter 1 Introduction



The *eXpertmeter™* EM720/EM720T

The EM720 is especially designed for utility, industrial and commercial billing metering with high requirements to reliability of power quality monitoring and availability of the device.

The *eXpertmeter™* EM720 is an electronic revenue-accuracy multi-rate polyphase static meter integrated with a multi-function powermeter, an EN50160 power quality recorder, a digital fault recorder and a programmable logical controller, and provided with a wide range of digital I/O and communication options.

A high-contrast graphical LCD display with backlight allows easy local meter readings and servicing. Two serial communication ports (infrared and RS232/RS485), a USB port, Ethernet and a wireless GSM/GPRS modem allow local and remote automatic meter readings and setup through the supplemental communication software or user data acquisition software

### Meter Highlights

#### Internal Rechargeable Backup Battery

A high-capacity rechargeable auxiliary battery allows the meter to continue uninterrupted operations for more than 3 hours with a NiMH battery and up to 7 hours with a Li-Ion battery in the event of an extended power outage.

#### EN 50160 Power Quality Recorder

A full-featured programmable power quality recorder provides EN 50160 compliance statistics and reports.



### Fast Transient Recorder

An optional high-voltage fast transient recorder (EM720T) detects impulsive and low frequency oscillatory transient overvoltages with peaks up to 2kV and durations from 20 microseconds.

### Digital Fault Recorder

An embedded fault recorder is capable of recording fault currents up to 50 amps.

## Meter Features

### Billing/TOU

- Class 0.2S IEC 62053-22 active energy and class 0.5 reactive energy polyphase static meter
- Time-of-Use, 10 billing energy and maximum demand registers, 8 tariff rates, 4 seasons x 4 types of days, 8 tariff changes per day
- One-time easy programmable tariff calendar schedule (embedded Hebrew holidays till 2039 for Israeli customers), one-time programmable or calendar scheduled daylight savings switch dates
- Tariff switching options: automatic via a tariff calendar schedule, external via communications or digital inputs
- Configurable triggering an end of billing period: automatic monthly, local from the front display, remote via communications
- Automatic recording billing energy, maximum demand and cumulative maximum demand registers for last 24 billing periods
- Automatic 120-day daily energy and maximum demand profile
- Automatic 120-day/15-minute or 240-day/30-minute energy load profile
- Easy access to the three previous billing period data via the front display
- Dynamic instrument transformer correction; up to 8 test points for both ratio and phase angle error correction for external PTs and CTs
- Power transformer/line loss compensation

### Multi-functional Power Meter

- High-accuracy 3-phase Power meter: true RMS volts and amps, powers, power factors, unbalance, neutral current, frequency
- Demand Meter: amps, volts, harmonic demands, block and sliding power demands

- Harmonic Analyzer: up to 50th harmonic volts and amps; fundamental volts, amps, power and power factor, phasor, symmetrical components

#### Power Quality

- EN 50160 Power Quality (PQ) recorder: onboard power quality analyzer; programmable limits; EN 50160 power quality event log, EN 50160 compliance statistics; EN 50160 harmonics survey statistics
- Power frequency, voltage variations, rapid voltage changes, IEC 61000-4-15 flicker, voltage dips, interruptions, temporary overvoltages, transient overvoltages, voltage unbalance, IEC 61000-4-7 harmonic and interharmonic voltage, mains signaling voltage
- High-voltage fast transient recorder (EM720T); impulsive and low frequency oscillatory transient overvoltages with peaks up to 2kV and durations from 20 microseconds
- Ready-for-use compliance statistics reports with the supplemental software

#### Fault Recorder

- Digital Fault recorder: three voltage and four current channels, up to 8 external digital triggers for monitoring circuit breakers and protection relays; onboard overcurrent and undervoltage fault detector; zero-sequence voltage and current, voltage and current unbalance; programmable fault thresholds and hysteresis
- Up to 50 Amp fault currents
- Ready-for-use fault reports with the supplementary software - fault current magnitudes and duration, coincident volt magnitude, fault waveforms and fast RMS trace

#### Event Recorder

- Event recorder for logging internal diagnostics events, setpoint and I/O operations

#### Waveform Recorders

- Three Waveform recorders: up to 7 channels simultaneous recording of three voltage and four current channels
- Fixed and event-controlled recording time
- Selectable sampling rate of 32, 64, 128 or 256 samples per cycle; 1-20 pre-fault cycles; 0-2048 post-fault cycles in event-controlled mode; up to 3 min of continuous recording at a rate of 32 samples per cycle
- Optional 4-channel transient voltage recording at 1024 samples per cycle (EM720T)

- Synchronized waveforms from multiple devices in a single plot
- Exporting waveforms in COMTRADE and PQDIF file formats

### Data Recorders

- Sixteen Data recorders
- Programmable data logs on a periodic basis and on any internal and external trigger; triggering from the Fault recorder, PQ recorder or control setpoints; exporting data trends in PQDIF file format
- Fast fault and PQ data profiling (trending) triggered from the Fault and PQ recorders: 1/2-cycle to 10-min RMS envelopes; up to 20 pre-fault and post-fault cycles

### Programmable Logical Controller

- Embedded Programmable Controller: 16 control setpoints
- OR/AND logic, extensive triggers, programmable thresholds and delays, relay control, event-driven data recording
- 8 digital counters for counting pulses from external sources and internal events
- 4 programmable timers from 1 cycle to 24 hours for periodic recording and triggering operations on a time basis.

### Time and Clock

- High-accuracy real-time clock with a lithium backup battery
- 1-ms satellite-synchronized clock option (IRIG-B time-code input)
- SNTP clock synchronization option
- 1PPM or 1PPS clock synchronization option via a fast digital input
- One-time programmable or calendar scheduled daylight saving time (DST) switch dates; configurable DST start and end time

### Extended Security

- 3-level password security for protecting meter setups and accumulated data from unauthorized changes

### Display

- Easy to read high contrast graphical 128x32 pixel LCD display with backlight
- Multi-page data display with auto-scroll; time, billing, instrumentation and service data

- Menu-driven setups

#### Digital I/O

- Four embedded digital inputs with 1 ms scan time
- Replaceable 2DI/2DO expansion I/O modules with 1/2 cycle scan/update time

#### Memory

- 8 or 16 Mbyte flash memory for long-term billing, event, waveform and data recording

#### Communications

- Front Infrared IEC 62056-21 serial communication port (IEC 62056-21, Modbus RTU/ASCII and DNP3 protocols)
- Plug-in serial RS232/RS485 communication port (Modbus RTU/ASCII and DNP3 protocols)
- Plug-in full speed USB 1.1 port (Modbus RTU protocol)
- Plug-in Ethernet port (Modbus/TCP and DNP3/TCP protocols, IEC 61850 – future releases), up to 5 simultaneous connections
- Plug-in wireless GSM/GPRS modem (Modbus/TCP and DNP3/TCP protocols)

#### Expansion I/O and Communication slots

- 3 expansion slots for plug-in I/O and communication modules

#### Backup Power Supplies

- Rechargeable auxiliary battery (more than 3 hours operation time with a NiMH battery, up to 7 hours operation with a Li-Ion battery)
- Auxiliary 24VDC backup power supply module
- Auxiliary 85-265VAC/90-290VDC backup power supply module

#### Upgradeable Firmware

- New features can be easily added to your meter by simply replacing firmware through any communication port.

#### Software Support

- PAS – free meter configuration and data acquisition tool
- eXpertPower™ – SATEC proprietary Internet services

## EM720 Models

The EM720 meter series includes two models:

- EM720 – basic model - offers all the EM720 billing, instrumentation, control, power quality and fault recording capabilities
- EM720T – fast transient model - adds to above a fast transient recorder with a capability of detecting transient overvoltages with peaks up to 2kV and durations of less than 20 microseconds

See the EM720 Installation Manual for technical specifications and ordering options.

## Supplemental Documents

BG0450 EM720 Installation Manual

BG0457 EM720 Modbus Reference Guide

BG0458 EM720 DNP3 Reference Guide

BG0460 EM720 IEC 62056-21 Reference Guide

BG0459 EM720 IEC 61850 Reference Guide

BG0337 PAS Getting Started Guide

## Meter Nameplate

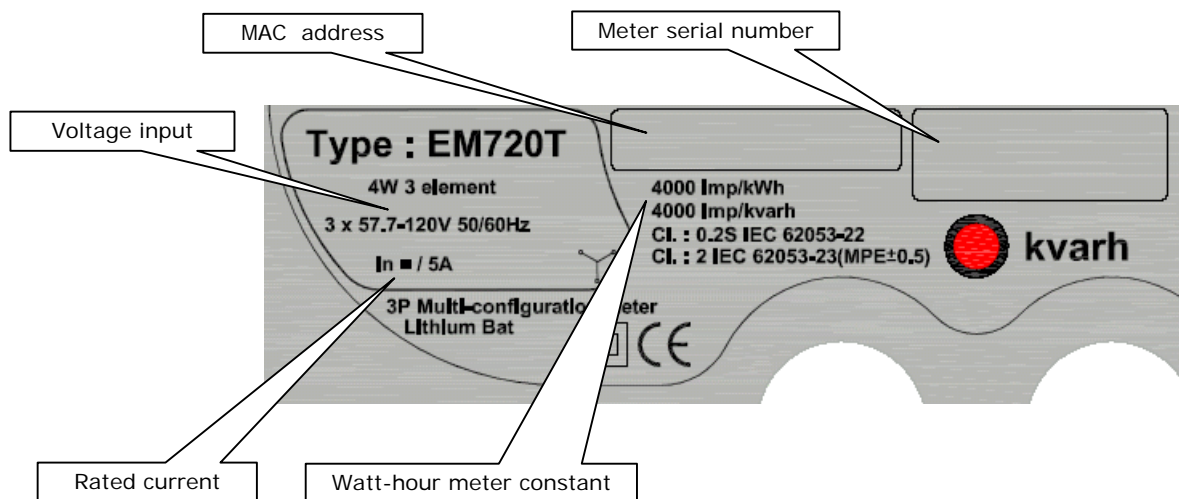

## Chapter 2 Operating the EM720

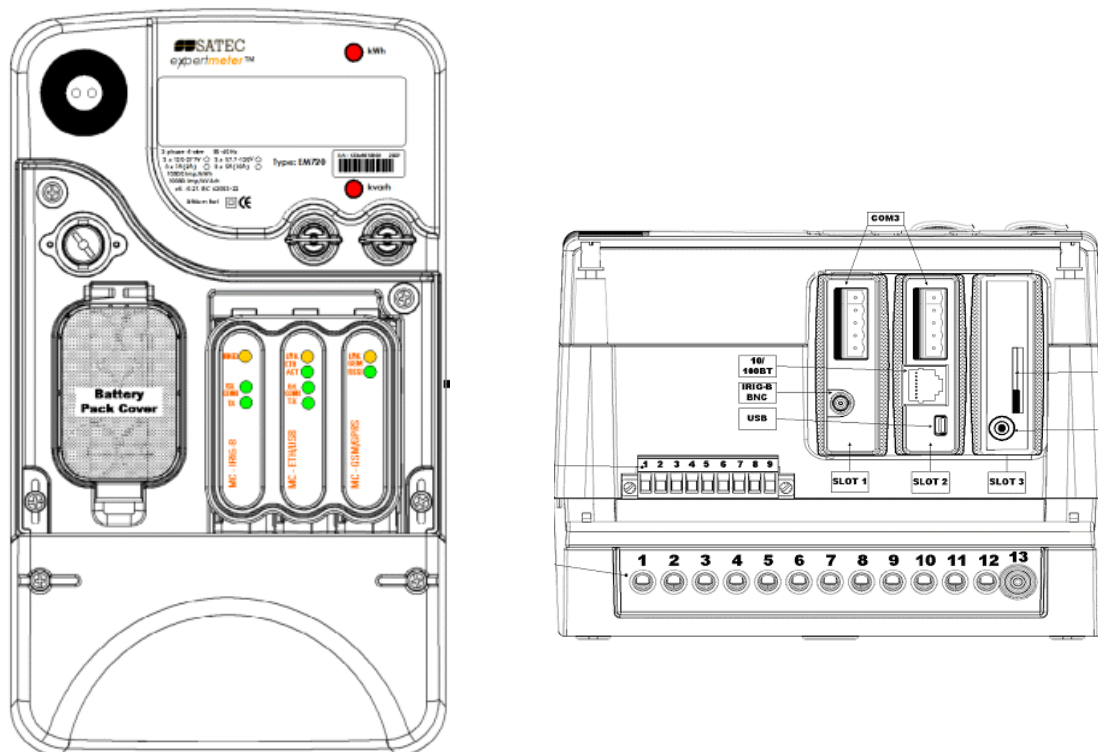

### Controls and Indicators

#### Push Buttons

The EM720 provides two sealable push buttons that do not have labels. They allow you to scroll through the multi-page display screens for local meter reading, to inspect or change meter setup parameters, and to control display operations.

See [Navigation Buttons](#) in Chapter 3 for buttons location and functionality.

#### Graphical Display Indicators

The EM720 graphical display is used both for displaying billing and instrumentation data, and for indication of the present tariff rate and important diagnostic information. See [Status Indicators](#) in Chapter 3 for information on graphical status indicators.

#### Energy Pulse LED Indicators

The EM720 is provided with two red LED indicators labeled as “kWh” and “kvarh” that flash when a load is applied to the meter.

The LED pulse rate in NORMAL mode is indicated on the meter nameplate. The standard LED pulse rates are listed in the following table. All indicated rates are in secondary units.

Rated Voltage, V	Secondary Current, A	Pulse Rate, imp/kWh
57-120	1	20,000
57-120	5	4,000
120-277	1	12,500
120-277	5	2,500

The LED pulse rate in TEST mode is user-programmable. The factory set defaults and available ranges are shown in the following table.

Rated Voltage, V	Secondary Current, A	Default Pulse Rate, imp/kWh (Wh/imp)	Range, imp/kWh (Wh/imp)
57-120	1	20,000 (0.05)	20,000-100,000 (0.01-0.05)
57-120	5	10,000 (0.10)	4,000-100,000 (0.01-0.25)
120-277	1	20,000 (0.05)	12,500-100,000 (0.01-0.08)
120-277	5	10,000 (0.10)	2,500-100,000 (0.01-0.40)

See [Device Options and Mode Control](#) in Chapter 5 on how to change the LED pulse rate in your meter.

## TEST Mode

TEST 0.10 Wh/Imp	1/1	
397.254 kWh	#	
40.631 kvarh	123	

The EM720 can run in NORMAL or in TEST mode.

TEST mode is intended for testing the device energy measurement accuracy without affecting the billing energy and demand data. All instrumentation data is still available in TEST mode.

The front pulse LED indicators flash at a programmable rate in TEST mode, and the billing data display shows separate test kWh and kvarh energy readings with an extended 0.001 kWh resolution.

See [Device Options and Mode Control](#) in Chapter 5 on how to put your meter in TEST mode and to change the test LED pulse rate. See [TEST Mode Data Display](#) for more information on the TEST mode display.

### NOTE

In TEST mode the following features are not operational:

- setpoints
- power quality recorder
- fault recorder
- relay outputs
- instrument transformer correction
- transformer/line loss compensation

## Device Diagnostics

DIAGNOSTICS: 3 msg	1/1	
1: Watchdog reset	00	
2: Power down	#	
3: Motion/tilt sensor	123	

Device diagnostic messages may appear as a result of the EM720 built-in diagnostic tests performed during start-up and device operation.

A blinking diagnostics indicator is shown on the display whenever there are diagnostic messages. See [Status](#)

[Indicators](#) in Chapter 3 for information on diagnostics indicators. See [Device Diagnostics Display](#) in Chapter 3 on how to inspect the meter diagnostics messages from the display.

The device diagnostics status is stored in a non-volatile register, which may be inspected and cleared from the meter display, via the supplemental PAS software, or from a user application. See [Viewing and Clearing Device Diagnostics](#) in Chapter 6 on how to clear the device diagnostics status in your meter.

All diagnostic events with time stamps are also recorded in the meter Event log and can be inspected via PAS (see [Retrieving Recorded Files](#) in Chapter 7).

In the event of a device fault, check the fault reason and clear the device diagnostics. See [Device Diagnostic Codes](#) in Appendix G for the list of diagnostic messages and their meanings. In the event of a time fault, update the device clock. In the event of a configuration reset, check the setup affected by the fault via the device Event log, and then verify the setup data.

Hardware failures are normally non-critical recoverable faults that do not cause a system failure but may cause data loss. Hardware failures are often caused by excessive electrical noise in the region of the device. If the device continuously resets itself, contact your local distributor.

### Device Fault Alarm

The EM720 provides a global "DEVICE FAULT" event flag that is asserted all the time while one of the diagnostic events exists. It can be monitored via a setpoint (see [Using Control Setpoints](#) in Chapter 5) to give a fault indication through a relay output. If the alarm relay is programmed for failsafe mode using inverting polarity, then its normally closed contacts will be open if either the meter loses power or a device fault occurs.

## Meter Security

Enter Password  
 ■■■■■■■■

The EM720 provides 3-level password security for protecting meter setups and accumulated data from unauthorized changes. Meter readings are not software protected.

Access to particular setup and control items is granted depending on the security level of the password you entered. The passwords can be 1 to 8 digits long.

The following table shows the meter security levels and user access rights.

Password	Security Level	Access Rights
Password 1	Low	Reset of billing and engineering maximum demands, and device diagnostics. Meter clock update. Display setup.



Password	Security Level	Access Rights
Password 2	Medium	TEST mode. Reset of meter and battery operation time counters, failure counters and pulse counters. Communications setup. I/O operation setup and control. Memory and recorders setup. Billing/TOU system setup.
Password 3	High (Administration level)	Meter passwords setup. Basic device setup. Device energy and power options setup. Reset of conventional log files.

The meter is primarily shipped with all passwords preset to 9 at the factory. It is highly recommended that you change the factory set passwords as fast as possible. See [Configuring Meter Passwords](#) in Chapter 5 on how to change passwords in your meter.

Password-tampering events are automatically recorded to the Event log file after every three unsuccessful login attempts in 5 minutes.

## Meter Clock and Time Synchronization

Time synchronization provides a common time basis for the meter billing and tariff system, and for the power quality and fault recorders so that events and disturbances can be compared to one another.

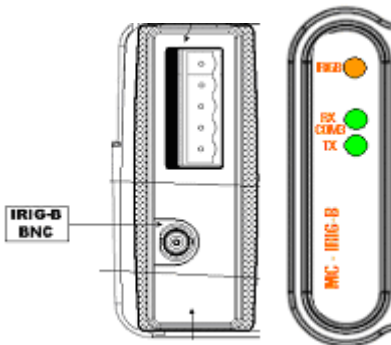

The EM720 can receive time synchronization signal either from a GPS satellite clock that has an IRIG-B time code output, or from another device that can provide minute-aligned time synchronization pulses through relay contacts.

The EM720 IRIG-B port uses unmodulated (pulse-width coded) time code signal (unbalanced 5V level). The red IRIG-B LED is blinking when the IRIG-B port receives a GPS clock signal.

The EM720 also provides an SNTP client that can receive precise time from an available SNTP server via the Internet.

See [Setting-Up SNTP Client](#) in Chapter 5 on how to configure the SNTP client.

See Time Synchronization Source in [Local Settings](#) setup for more information on how to select an external time synchronization source in your meter.

## Monitoring Meter Batteries

The EM720 is provided with a rechargeable auxiliary battery that can supply power in the event of long outages without the need of an external power supply.

A second backup lithium battery keeps the meter clock running when the meter goes to standby after the auxiliary battery is discharged.

```

DEVICE INFO      4/10 [ ]
Lithium battery  OK
Battery date    <28/06/10> +
Operation time  2.4 h 123

```

```

DEVICE INFO      5/10 [ ]
Aux. battery    8.24 V
Battery date    <28/06/10> +
                123

```

You can monitor the status of batteries from the front display on the Device Info pages (see [Device Info Display](#) in Chapter 3) and via the device diagnostics.

The auxiliary battery voltage is about 8.2 volts at full charge (for at least 20 hours). If it falls below, then the battery should be checked.

When the lithium battery voltage drops below the minimum allowed level, it is indicated by the blinking “Battery Low” icon on the display and via the device diagnostics. In this event, the battery should be checked and replaced if required.

#### NOTE

Always clear the battery operation time counters after replacing a battery. See [Resetting Accumulators and Clearing Log Files](#) in Chapter 6 for information on how to clear the operation counters in your meter.

## Billing and Energy Metering

The EM720 provides true four-quadrant energy measurements with Class 0.2S IEC 62053-22 accuracy. The following energy quantities are available for instrumentation and billing:

- kWh import (Q1+Q4)
- kWh export (Q2+Q3)
- kWh net (Q1+Q4)-(Q2+Q3) - instrumentation
- kvarh import (Q1+Q2)
- kvarh export (Q3+Q4)
- kvarh net (Q1+Q2)-(Q3+Q4) - instrumentation
- kvarh Q1, Q2, Q3, Q4 quadrants
- kVAh import (Q1+Q4)
- kVAh export (Q2+Q3)
- kVAh total (Q1+Q2+Q3+Q4)

### Energy Measurement Channels

The EM720 uses two independent current channels for high-accuracy energy measurements and for conventional high-range instrumentation. They have different gain and measurement ranges as necessary for billing accuracy energy metering and for power quality and fault monitoring.

1-second currents and powers provided by the meter and the corresponding engineering display readings are taken from the energy measurement channel. They begin measurements from 5 mA starting currents and up to 10 A RMS with 5 A secondaries, while instrumentation currents provide measurements up to 50 A RMS.

## Energy Counters

The EM720 provides instrumentation energy and billing energy metering. Both use the same energy measurement circuitry as a source input for accumulation energies but operate independently.

Energy counters have a nine-digit kWh resolution with one decimal place by default. You can set the energy counters to have fewer digits by changing the default energy roll value in your meter (see [Device Options and Mode Control](#) in Chapter 5).

Billing energy registers have the same resolution as instrumentation energy counters.

## Billing Energy Registers

The EM720 has 10 fully programmable billing energy registers that can be linked to any internal energy source or to any external pulse source that delivers pulses through the device digital inputs.

Any of energy registers can provide either a single-tariff energy accumulation or be individually linked to the TOU system providing both total and multi-tariff energy billing.

See [Configuring Billing/TOU](#) in Chapter 5 on how to configure the meter billing registers and tariff schedule for your application.

## Maximum Demand Registers

Any of billing energy registers can be individually linked to the maximum demand and cumulative maximum demand registers providing the same demand tariff structure as you selected for energy registers.

## Tariff Rates

The EM720 provides three options for switching tariff rates:

- automatic via a programmable TOU calendar schedule
- external via communications by direct writing a tariff number to the meter tariff register
- external via digital inputs by providing a tariff number code on the meter tariff inputs

See [Device Options and Mode Control](#) in Chapter 5 on how to program the tariff control mode and select tariff inputs in your meter.

The meter tariff structure supports 8 different tariff rates using an arbitrary tariff schedule.

The EM720 TOU calendar provides a season tariff schedule and an option for scheduled daylight savings switch dates. A total of 4 types of days and 4 seasons are supported with up to eight tariff changes per day. See [Configuring Billing/TOU](#) for more information on programming the tariff calendar schedule in your meter.

The present tariff rate is indicated on the EM720 display. If required, tariff-switching pulses with a programmable duration can be output via the meter relays.

### End of Billing

The EM720 can be configured to trigger a reset of billing maximum demands and an end of billing period automatically on a monthly schedule, manually from the front display and remotely via communications. It can also be done via control setpoints using any programmable internal or external trigger, like a specific time schedule or an external pulse.

You can select the reset sources via the Device Options setup (see [Device Options and Mode Control](#) in Chapter 5).

The EM720 uses a one-day protection lockout time to avoid multiple consecutive resets of the billing maximum demands.

### Billing Data Recording and Load Profiling

The EM720 provides automatic recording of the billing data to flash files:

- Monthly billing period data for the last 24 billing periods
- Daily energy and maximum demand profile for the last 120 days
- 15-min energy load profile for 120 days or 30-min profile for 240 days.

Maximum demand profiling for monthly and daily billing data profiles can be individually configured for every register.

See [Factory Preset Data Log Files](#) in Chapter 5 and [Billing and Load Profile Log Files](#) in Appendix C for more information on the file layout and contents.

### Billing Data Display

The EM720 display indicates billing energy, maximum demand and cumulative maximum demand registers for the present billing period and for three previous billing periods.

The display is automatically configured for your set of billing registers and your tariff schedule. See [Billing Period Data Displays](#) in Chapter 3 for the display layout.

## Instrumentation Metering

Instrumentation metering provides real-time measurements and time-integration for local and remote power monitoring and control, and a source for power quality evaluation and triggering the logical controller and Fault recorder.

See [Parameters for Monitoring and Logging](#) in Appendix A for a full list of the electricity and status measurements provided by the EM720.

All RMS quantities are based on 1/2-cycle true RMS measurements as per IEC 61000-4-30.

Voltage and current harmonic measurements are based on 10-cycle/50Hz or 12-cycle/60Hz waveforms (per IEC 61000-4-7), sampled at a rate of 128 samples/cycle. The EM720 uses dynamic sampling techniques to maintain a steady sampling rate and avoid instrumentation errors when the line frequency changes.

The meter provides short and long term flicker measurements as per IEC 61000-4-15.

The following table shows time-aggregation intervals available for different RMS and power quantities.

Parameter	1/2 cycle	1 cycle	200 ms	1 sec	3 sec	10 sec	10 min	2 hours
RMS volts	x	x	x	x	x		x	x
RMS currents	x	x	x	x <sup>1</sup>	x		x	x
Powers		x <sup>3</sup>		x <sup>1</sup>				
Zero-sequence	x	x	x	x	x		x	x
Unbalance	x	x	x	x	x		x	
Frequency		x	x	x		x	x	
Total harmonics		x	x	x	x		x	
Total interharmonics			x		x		x	
Individual harmonics			x				x <sup>2</sup>	
Individual interharmonics			x				x <sup>2</sup>	
K-factor		x	x	x	x		x	
Flicker							x	x
Symmetrical components			x				x	
Phasors			x					

<sup>1</sup> Taken from the energy measurement channel

<sup>2</sup> Only for power quality evaluation

<sup>3</sup> Not affected by loss compensation

## Instrument Transformer Correction

Ratio and phase angle error correction can be applied to external CTs and PTs to achieve overall metering installation accuracy, or be used in any metering installation to optimize the accuracy of the metering data.

The user can program up to 8 test points for both ratio correction and phase angle error curves covering the typical transformer operating range.

The EM720 is able to calculate the transformer errors dynamically based on the transformer performance characteristics and the actual CT current and PT voltage signals appearing at the meter, to interpolate to the actual measured operating point and to apply the interpolated error corrections to the meter calculations.

See [Instrument Transformer Correction Setup](#) on how to program the ratio correction factors and phase angle errors for external CTs and PTs and enable correction in the meter. See [Device Options and Mode Control](#) on how to enable and disable correction in the meter via the front display.

## NOTES

1. When transformer correction is enabled, it is applied to all instrumentation, billing and power quality calculations and waveforms.
2. Transformer correction does not affect test LED pulse outputs.
3. Transformer correction is not operational in test mode regardless of the option's status.

## Power Transformer/Line Loss Compensation

Loss compensation allows accounting for losses in power transformers and/or power line in the event the billing and metering points are located at different sides of the power transformer or at different sides of the power line.

The calculated compensation values for kW and kvar losses are added to the measured power quantities and energies.

The compensation values will be either positive, or negative depending on whether losses are calculated at the supply side or at the load side of the power transformer. They will be positive if the meter is located at the load side while the billing point is on the supply side, and negative in the opposite direction.

The instantaneous kW and kvar losses for iron and copper can be read and inspected via communications.

See [Transformer/Line Loss Compensation Setup](#) in Chapter 5 on how to program the loss constants and enable compensation in your meter. See [Device Options and Mode Control](#) on how to enable and disable compensation in the meter via the front display.

## NOTES

1. When loss compensation is enabled, it is applied to all billing data - one-second power values, power demands and energy quantities. Loss compensation does not affect instrumentation data – real-time power and fundamental power values.
2. Loss compensation does not affect test LED pulse outputs.
3. Loss compensation is not operational in meter test mode regardless of the option's status.

## Operating Digital Inputs

The EM720 can monitor a total of 8 digital inputs including four fast internal digital inputs and up to 2 replaceable two-channel 2DI/2DO modules. See the EM720 Installation Manual for digital input ratings and connection diagrams.

The 2DI/2DO module is provided with four indication LEDs that show the status of the digital inputs and relay outputs:

LED	Color	Status	Description
IN1, IN2	Yellow	Lights	The digital input terminals are shorted
OUT1, OUT2	Green	Lights	The normally open relay contacts are closed

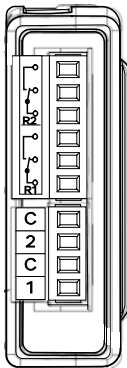

2DI/2DO MODULE

Fast internal digital inputs are sampled at a 1-ms rate, and expansion inputs are sampled at a 1/2-cycle rate.

Digital inputs functionality is programmable in the EM720 and any digital input can perform multiple metering and control functions at the same time:

- Receiving energy pulses from external watt meters (sub metering) – link a digital input to a Billing/TOU register and provide a required multiplication factor (see [Configuring Billing/Tariff Registers](#) in Chapter 5)
- Counting pulses from external pulse sources – link a digital input to a pulse counter (see [Using Counters](#) in Chapter 5)
- Triggering a setpoint – put a digital input into a setpoint trigger list (see [Using Control Setpoints](#) in Chapter 5)
- Triggering the Fault Recorder – link a digital input to the Fault Recorder (see [Configuring Digital Inputs](#) in Chapter 5) and enable external triggers in the Fault Recorder setup (see [Configuring the Fault Recorder](#) in Chapter 5)
- External synchronization of power demand intervals – select a digital input as an external power demand sync source (see [Basic Meter Setup](#) in Chapter 5)
- External synchronization of the meter clock – select a digital input as a time synchronization input (see [Local Settings](#) in Chapter 5) and provide minute-aligned pulses from the external master clock source.

All digital inputs have a user-programmable debounce time from one to 100 milliseconds. See [Configuring Digital Inputs](#) in Chapter 5 on how to configure digital inputs in your meter.

## Operating Relay Outputs

Up to four relay outputs can be provided in your EM720 with two expansion 2-channel 2DI/2DO replaceable modules. See the EM720 Installation Manual for available relay output ratings and connections.

See Section [Operating Digital Inputs](#) above for the relay terminals location and relay status LED indicators.

All relay outputs are updated at a half-cycle rate.

Each relay is independently programmable in the EM720 and can operate in latched, unlatched, pulse or KYZ mode.

Relay operations can be inverted so that the relay is energized in its non-active state and de-energized when it is operated. This mode, known as “failsafe” mode, may be used for signaling purposes to send alarms when the device is not operational either due to a fault or due to loss of power.

Each relay can be operated either locally from a control setpoint in response to an internal or external event, or by a remote command sent through communications, or can be directly linked to an internal pulse source producing energy or interval pulses.

See [Configuring Relay Outputs](#) in Chapter 5 on how to configure relay outputs in your meter.

See [Using Control Setpoints](#) in Chapter 5 on how to operate relay outputs via setpoints.

See [Remote Relay Control](#) in Chapter 6 on how to operate relays via PAS.

## Operating the Logical Controller

The embedded logical controller allows monitoring any measured quantity or external contacts to provide indication, counting and recording events whenever the value exceeds the predefined threshold or when a status transition is detected on the meter inputs. It provides a 1/2-cycle response time for fast analog and digital triggers.

The controller can monitor internal diagnostic events and meter operation status to give a fault indication via relay outputs or provide cross triggering multiple devices.

All controller operations can be recorded to the meter Event log with indication of the event time, source and a trigger value.

See [Using Control Setpoints](#) in Chapter 5 on how to configure the meter logical controller for your application.

## Operating the Event Recorder

The Event recorder automatically records time-tagged self-supervision events related to configuration changes, resets, and device diagnostics.

It can also record setpoint-monitored events and setpoint operations for setpoints individually configured for triggering the Event recorder.

See [Configuring the Event Recorder](#) in Chapter 5 for more information.

## Operating the EN50160 Power Quality Recorder

The EN 50160 Power Quality (PQ) recorder provides EN 50160 power quality statistics for EN 50160 compliance reports, and long-term harmonics survey statistics for trouble-shooting harmonic problems throughout an electrical network. It also records time-tagged voltage disturbances and voltage fault events into the Power Quality event log.

All power quality triggers have programmable thresholds and can be adjusted for a specific application.

The PQ recorder is configurable for triggering the Waveform recorder to record fault voltage and current waveforms before, within and after an event, and can also trigger the Data recorder for long-duration profiling of RMS voltages and



currents while the event continues, using a variable recording rate and variable averaging intervals.

See [Configuring the EN50160 Recorders](#) in Chapter 5 and [EN50160 Evaluation and Recording](#) in Appendix E for more information on configuring and operating the PQ recorder.

## Operating the Fast Transient Recorder

The fast transient recorder is provided with EM720T meters. It can detect impulsive and low frequency oscillatory transient overvoltages with peaks up to 2kV and durations from 20 microseconds.

The recorder does not require any special setup above a conventional PQ recorder setup for transient overvoltages. Waveform log #3 is especially dedicated for fast transient waveforms. It automatically stores 1-cycle voltage waveforms sampled at a rate of 1024 samples/cycle whenever a transient overvoltage is detected.

Unlike a basic transient recorder provided with the EM720 that detects and records transient voltages between phase conductors and a neutral terminal (in 4LN3 and 3LN3 configurations), or between two phase conductors (in line-to-line configurations), the fast transient recorder detects transient voltages between phase conductors and a ground terminal and between the neutral and a ground terminal regardless of a wiring configuration.

See the EM720 Installation Manual for the terminal location and wiring diagrams. To help you check your voltage connections, the EM720 provides 1-cycle phase RMS voltages V1x through V3x, and 1-cycle neutral voltage V4x relative to the ground terminal, that you can monitor via PAS.

## Operating the Fault Recorder

The programmable Fault recorder stores time-tagged fault events into the fault event report. It can be triggered externally through a digital input or internally from the embedded fault detector.

The fault detector can automatically detect different fault categories using the meter sub-cycle measurements. Fault triggers have programmable thresholds and hysteresis and can be adjusted for specific substation conditions.

The Fault recorder is programmable for triggering the Waveform recorder to record fault voltage and current waveforms before, within and after a fault event, and can trigger the Data recorder for fast profiling of RMS voltages and currents during a fault.

See [Configuring the Fault Recorder](#) in Chapter 5 for more information on operation of the Fault recorder.

## Communicating with the EM720

Communication with the EM720 is provided either via the embedded optical IR port, or via the replaceable communication ports. See the EM720 Installation Manual for

the full list of the available communication modules and communication options.

### Infrared Port

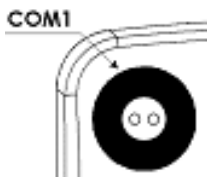

The EM720 has an optical infrared port for local meter reading via a hand-held unit or a portable PC. The IR port can be equipped with an IEC- or ANSI-compatible optical head on your selection.

The IR port is identified in the EM720 as port COM1. It is factory preset to 19200 bps, 8-bits/No-parity data format, and is pre-programmed for the IEC 62056-21 protocol.

You can change the default baud rate or protocol for the IR port from the front display or via PAS (see [Setting Up Serial Communication Ports](#) in Chapter 5).

### Serial Communications

Most of the replaceable communication modules you can order with your EM720 have an additional RS-232/RS-485 serial port. It is easily configurable for either RS-232, or RS-485 serial communications. See the EM720 Installation Manual for the serial port wiring.

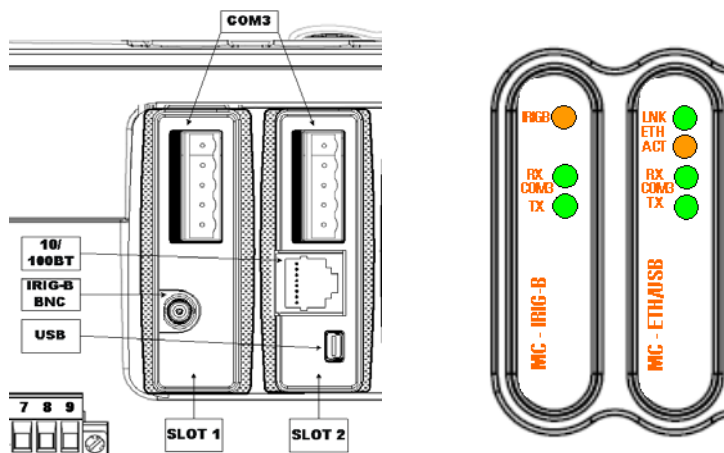

An RS-232/RS-485 serial port is identified in the EM720 as port COM3. If you installed communication modules with more than one serial port, only the port located in the left-hand slot will be enabled.

The COM3 port is provided with two green RX and TX LEDs that blink when the port receives or transmits data.

```

DEVICE INFO          7/9
COM1 1,19.2,IEC 62056-21
COM2 1,GPRS          #
COM3 1,19.2,Modbus RTU 123
    
```

The port is factory preset to 19200 bps, 8-bits/No-parity data format, and is pre-programmed for the Modbus RTU protocol. See [Setting Up Serial Communication Ports](#) on how to change the factory-set options for your serial port.

You can check the present serial port settings in your meter via the Device Info display (see [Device Info Display](#) in Chapter 3).

## Ethernet Connection

An optional 10/100Base-T Ethernet/USB module provides a direct connection of the EM720 to the Ethernet.

The port has two indication LEDs that operate as follows:

LED	Color	Status	Description
LINK	Green	Lights	The good link is detected (slightly blinks when the port receives or transmits data)
ACT	Red	Blinks	Activity on the port - the port receives or transmits data

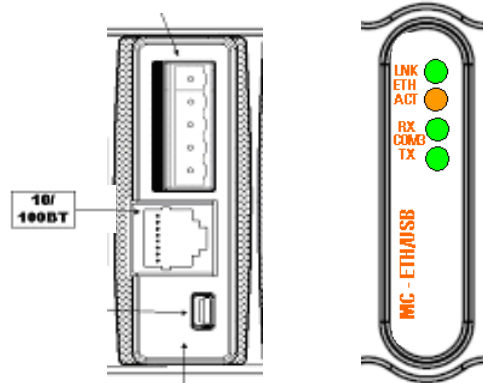

The EM720 provides two TCP servers configured for the Modbus/TCP (on port 502) and DNP3.0/TCP (on port 20000) communications.

The TCP servers support 5 simultaneous Internet connections with client applications. Connection through the Ethernet port does not require device identification. The meter responds to any device address and returns the received address in the response message.

The meter also provides three TCP clients:

- SNTP client for periodic synchronization of the meter clock with a publicly available SNTP server (see [Setting-Up SNTP Client](#))
- eXpertPower™ client for communications with the proprietary eXpertPower™ server (see [Setting-Up eXpertPower Client](#))
- TCP notification client that can establish connections with a remote Modbus/TCP server and send notification messages either on events, or periodically on a time basis (see [Setting-Up TCP Notification Client](#))

See [Setting Up the Ethernet](#) in Chapter 5 on how to configure your Ethernet port.

DEVICE INFO		8/8	8
MAC	0005F00000AA		
IP Address	192.168.0.203	#	
Gateway	192.168.0.1		123

You can check the Ethernet port MAC address and present IP address setting via the Device Info display (see [Device Info Display](#) in Chapter 3).

### GSM/GPRS Wireless Communication

An optional GSM/GPRS modem can be provided with the EM720 for wireless communications via a cellular GPRS network. It is identified by the EM720 as port COM2.

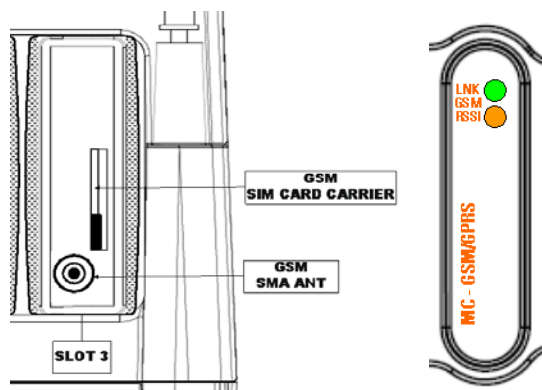

A GSM/GPRS module may only be installed into expansion slot 3.

The module has two indication LEDs that operate as follows:

LED	Color	Status	Description
LINK	Green	Flashes/Lights	Flashes while the modem is registering on the GPRS network and is lit up after the meter has logged on the network
RSSI	Yellow	Flashes	Received signal strength indicator - shows the quality of the received signal as follows: Flashes once a second – good quality – the signal strength is above -109 dBm. Flashes twice a second – bad quality – the signal strength is less than -109 dBm. Shut off – the signal strength is not known or not detected.

See [Setting-Up Dial-Up GPRS Network](#) in Chapter 5 on how to configure the GPRS modem and how to check a dynamically assigned IP address the meter got from the GPRS network.

```

DEVICE INFO          9-9 8
GPRS IP      172.16.175.80
GPRS RSSI    -79 dBm      ++
                                     123
    
```

You can also check the meter IP address and the quality of the received signal via the Device Info display (see [Device Info Display](#) in Chapter 3).

The EM720 eXpertPower™ client and TCP notification client can establish connections with remote servers via a GPRS network. When both the Ethernet and GPRS modules are installed, you should manually select the preferred network for client connections.

**NOTE**

When a new module is installed, or either Ethernet or GPRS network parameters are changed, the meter logs out of the network so the IP address you might use for connecting to the meter will no longer be effective. Check the meter for a new GPRS IP address either from the front display, or via PAS.

## USB Communications

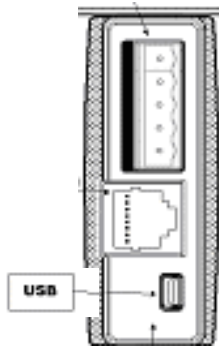

An optional Ethernet/USB module provides a full speed 12-Mbit USB 1.1 port for local communications with the support PAS software. The USB module can be installed in the expansion slot 1 or 2.

USB communications does not require any settings. Just connect your PC to the EM720 USB port using the supplied USB cable with a mini-USB connector and install the USB driver provided on the CD with your meter (see [Installing the USB Driver](#) in Chapter 4).



**To prevent potential differences between the PC USB port and the EM720 USB device port, it is recommended to use a galvanically isolated USB adaptor before connecting the EM720 USB port to a PC, or to use a battery powered PC.**

## Auxiliary AC/DC Backup Power Supplies

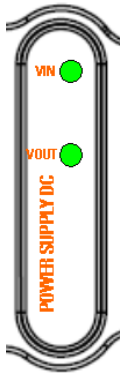

An auxiliary 24VDC or 85-265VAC/90-290VDC backup power supply module can be provided for powering the meter from an external power source, like a station battery, in the event of power outages. It can be used either as a replacement for the internal auxiliary backup battery, or as an additional backup source for maintaining continuous uninterrupted operation of the meter.

The module can be installed into any expansion slot.

See the EM720 Installation Manual for the power supply ratings and connection diagrams.

The 24VDC supply module has two indication LEDs that operate as follows:

LED	Color	Status	Description
VIN	Green	Lights	External DC voltage is applied to the input terminals
VOUT	Green	Lights/ Shut off	Lights- the module supplies the power to the meter while the AC voltages are not available on any reason Shut off – the module is in standby while the meter is powered from the AC inputs

The AC/DC supply module is provided with a green LED that lights when the external voltage is applied to the input terminals.

## Chapter 3 Using Front Display



### Display Operations



The EM720 has a high-contrast graphical LCD display with backlight for local data read outs, meter setup and servicing.

The display operates in two modes:

- Multi-page data display mode with Auto-Scroll feature allows you to scroll through display screens and pages to view various billing, instrumentation and status data.
- Programming mode allows you to enter menu-driven device setups for inspecting and changing factory set meter parameters, or resetting maximum demands, counters and device diagnostics messages.

The display is normally updated once per second except of the clock display where the update rate changes to twice per second.

### Navigation Buttons

The EM720 is provided with two sealable navigation buttons that do not have labels. See the picture above for button locations and their functionality.

You can perform three types of actions with each button:

- Short press, or "press and release"
- Long press, or "press and hold for 1 to 2 seconds"
- Extended press, or "press and hold for 5 seconds or longer "

The function of each button changes depending on what operating mode the display is in.

The **SCROLL** button operates once it's briefly pressed. It has two functions:

- In data display mode, it scrolls through the display pages.
- In programming mode, it scrolls through the menu items and allows changing a selected digit when entering numbers.

The **SELECT/ENTER** button normally operates once it's released. The button function changes depending on the time the button is pressed:

- In data display mode, when pressed briefly and released, it scrolls through the display views; a long press for more than 5 seconds switches to programming mode.
- In programming mode, when pressed briefly and released, it moves from one menu item to another; a long press for one second selects a highlighted menu item allowing to enter a submenu or to store a changed item.

In data display mode, when the **SCROLL** and **SELECT/ENTER** buttons are briefly pressed together and then released, the current display returns to the start page; in some pages, an extended press for more than 5 seconds is used as a "shortcut" for immediate entering a specific programming menu.

## Navigating in Data Display Mode

The following table gives a summary of the button operations in data display mode.

Button	Press	Operations
SCROLL	Short press	Scroll through pages
SELECT/ENTER	Short press	Scroll through displays
SCROLL + SELECT/ENTER	Short press	Return to the start page within a present display
SCROLL + SELECT/ENTER in the clock page	Short press	Enter to/Return from the test display
SCROLL + SELECT/ENTER in selected pages	Extended press	Shortcut for entering a specific menu in programming mode
SELECT/ENTER	Extended press	Enter programming mode

The EM720 provides 9 different multi-page data displays. Your present location is indicated by three numbers at upper right of the display as shown in the following picture. See [Data Displays](#) for the full displays list and enumeration.

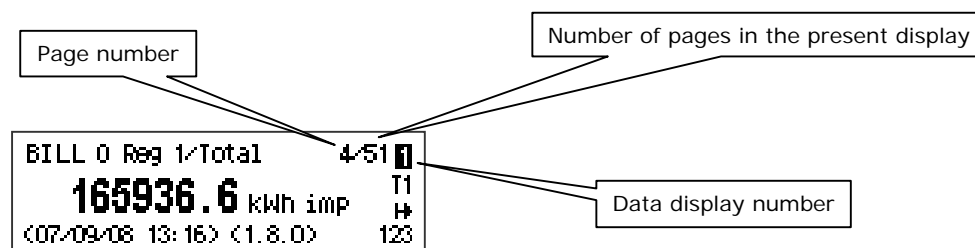

Use a short press on the SELECT/ENTER button to scroll through displays. Use a short press on the SCROLL button to scroll through the pages.

### Status Indicators

Graphical icons at right give immediate meter status indication and show the present tariff rate.

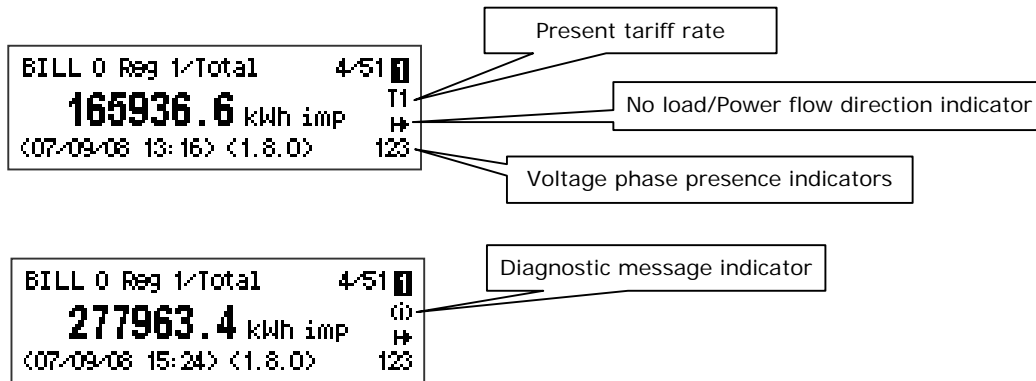

#### Tariff Rate Indicator

The tariff rate indicator (T1 through T8) is only shown on the billing data displays. It indicates the currently active tariff rate. Whenever there is an important diagnostic message, the tariff rate indicator alternates with a blinking diagnostic indicator (see below).

#### Diagnostic Indicators

The diagnostic indicators listed in the following table are displayed as blinking icons. If there are a number of diagnostic events, a higher priority event is indicated first.

Indicator Icon	Event Priority	Description
	High	Low lithium battery indicator with auto-reset. Indicates that the battery voltage is below its operational limit. The battery should be checked and replaced. See the meter installation manual for the battery replacement procedure. The icon is automatically shut down after the battery voltage returns to its normal value. The battery date and operation time can be inspected via the Device Info display (see <a href="#">Device Info Display</a> ). After replacing the battery, reset the battery operation time via the reset menu (see <a href="#">Resetting Accumulators and Log Files</a> ).
	Medium	Electromagnetic field indicator with auto-reset. Indicates presence of a high electromagnetic field that can affect accuracy of energy measurements. The electromagnetic interference event start and end time are recorded in the meter event log. The icon is automatically shut down after the electromagnetic field disappears.



ⓘ	Low	<p>General diagnostic message indicator: indicates that there are diagnostic messages you can inspect via the DIAGNOSTICS display.</p> <p>The icon is shut down after you explicitly reset diagnostics messages either from the display or via communications (see <a href="#">Clearing Device Diagnostics</a>).</p> <p>You can disable diagnostic message indicator via the Display Setup menu (see <a href="#">Display Setup</a>).</p>
---	-----	--

### No Load/Power Flow Direction Indicator

The power flow indicator gives information on the load presence and shows the direction of active power.

Indicator Icon	Description
⊞	No load.
→	Direct active power flow – imported (delivered) active energy.
←	Reversed active power flow – exported (received) active energy.

### Phase Presence Indicators

Phase presence indicators “123” show the status of either V1-V2-V3 phase-to-neutral voltages in line-to-neutral wiring modes, or V12-V23-V31 phase-to-phase voltages in line-to-line wiring modes.

Indicator Icon	Description
123	All voltages are present and above the voltage dip threshold.
1 3 123	Blinking phase indicator – the phase voltage is below the defined voltage dip threshold. Possibly indicates an incorrect meter nominal voltage setting (see <a href="#">Basic Meter Setup</a> in Chapter 5).
1-3	Dashed phase indicator - the phase voltage is either missing or below the voltage interruption threshold.

If the phase voltage is below the defined voltage dip threshold, its corresponding phase indicator is blinking.

If the phase voltage is either missing or below the voltage interruption threshold, the phase indicator is replaced with a dash.

## Display Features

The EM720 display has a number of programmable features that can be disabled, enabled and adjusted via the meter Display Setup (see [Display Setup](#) in Chapter 5).

### Backlight

A short press on any button while the display backlight is off switches the backlight on.

The backlight stays on as long as you selected in the display setup and then dims to conserve power. The backlight time is factory set to 1 minute and can be programmed from 1 to 10 minutes. You can temporarily set the backlight to continuous operation if you need to work in dark for more time.

The backlight is not operational if voltages are missing on meter terminals while the meter is powered from the battery.

### Auto-Return

If the Auto-Return feature is enabled and no button is pressed for the programmable Auto-Return interval (1 to 30 minutes for data displays; fixed at 5 minutes for setup menus), the display automatically returns to the default page from any other data display or a setup menu.

If the Auto-Scroll feature is enabled, the display immediately enters the auto scroll sequence.

### Auto-Scroll

If the Auto-Scroll feature is enabled, the data display automatically scrolls through all pages of all data displays that are included into the programmable auto-scroll sequence. The scroll interval is adjustable in the range of 2 to 30 seconds. The scroll sequence may include all or only selected displays.

The display automatically enters auto scrolling if no button is pressed for the Auto-Return interval when the Auto-Return feature is enabled, or in 1 minute if this feature is disabled. In the last case, the scroll sequence is restored from the point where it was interrupted.

To stop auto scrolling, press briefly any button if the backlight is on; else press briefly any button twice since the first press only sets the backlight on and does not affect auto scrolling.

Auto-Scroll is not operational in TEST mode.

## Measurement Units

The following table shows the display resolution for common displayed quantities. All measured data is displayed in primary units.

Measured Quantity	Voltage Connection	Units and Display Resolution
Energy		kWh, kvarh, kVAh with one decimal place. The number of digits is programmable (see <a href="#">Device Options and Mode Control</a> in Chapter 5).
Power	Direct (PT = 1.0)	kW, kvar, kVA with three decimal places
	Transformer (PT > 1.0)	MW, Mvar, MVA with three decimal places
Voltage	Direct (PT = 1.0)	Volts with one decimal place
	Transformer (PT > 1.0)	Kilovolts with three decimal places
Current		Amperes with two decimal places

## Data Displays

The EM720 has 9 multi-page data displays listed in the following table.

Display Number	Display Label	Display Contents
1	BILL 0	Present (0) billing period data
2	BILL 1	Last (-1) billing period data
3	BILL 2	Second previous (-2) billing period data
4	BILL 3	Third previous (-3) billing period data
5	MAX. DEMAND	Engineering maximum demands
6	ENGINEERING	Instrumentation data
7	SETUP	Basic meter setup data
8	DEVICE INFO	Device service data
9	DIAGNOSTICS	Device diagnostics messages

### TEST Mode Data Display

The TEST data display is shown in TEST mode in place of the billing period data displays. See [Device Options and Mode Control](#) in Chapter 5 on how to enter the meter TEST mode.

	<p>TEST mode display: test LED pulse rate in secondary Wh/imp, test kWh and kvarh energy registers readings in primary units with an extended 0.001 kWh resolution.</p> <p>Extended press SCROLL + SELECT/ENTER is a shortcut for immediate entering the TEST mode setup menu.</p>
--	--

### Billing Period Data Displays

The EM720 provides four billing data displays: one for the present billing period and others – for three previous billing periods. All displays have a layout shown in the following picture. See [OBIS Identification Codes](#) in Appendix H for a list of OBIS codes indicated in the displays.

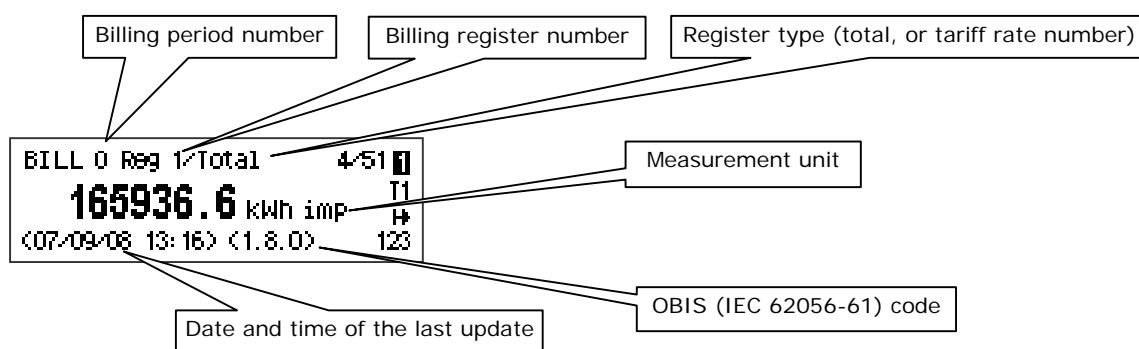

Each billing period display lists all total and tariff energy, maximum demand and cumulative maximum demand registers for all configured billing registers and all active tariffs.

The EM720 automatically arranges pages in each display. Only registers you selected in the billing/TOU register setup and tariff rates listed in the TOU daily profiles are included



(see [Configuring Billing/Tariff Registers](#) and [Configuring the Daily Tariff Schedule](#) in Chapter 5).







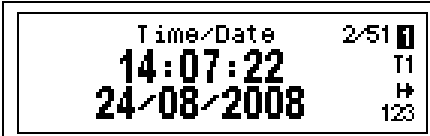

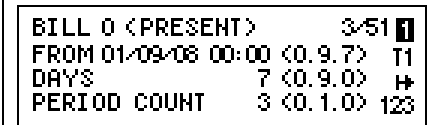
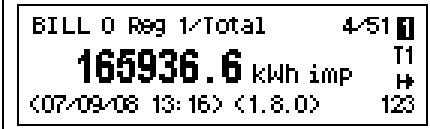

The order of pages is shown in the following table.

Number of Pages	Display Contents
1-10	Register 1...10 total energy readings
1-8	Register 1 tariff 1...8 energy readings
1-8	Register 2 tariff 1...8 energy readings
...	...
1-8	Register 10 tariff 1... 8 energy readings
1-10	Register 1...10 total maximum demand
1-8	Register 1 tariff 1...8 maximum demand
1-8	Register 2 tariff 1...8 maximum demand
...	...
1-8	Register 10 tariff 1...8 maximum demand
1-10	Register 1...10 total cumulative maximum demand
1-8	Register 1 tariff 1...8 cumulative maximum demand
1-8	Register 2 tariff 1...8 cumulative maximum demand
...	...
1-8	Register 10 tariff 1...8 cumulative maximum demand

### Present Billing Period Data

The following example demonstrates the present billing period displays for four configured billing registers (kWh imported and exported, kvarh imported and exported) and for three active tariff rates. The actual register contents in your installation may be different depending on your selection of register sources.

	<p>Clock display. Indicates present time and date. The date order can be changed via the Local Settings setup menu (see <a href="#">Local Settings</a> in Chapter 5)</p> <p>Short press SCROLL + SELECT/ENTER moves to the test pattern display page.</p> <p>Extended press SCROLL + SELECT/ENTER is a shortcut for immediate entering the clock setup menu.</p>
	<p>Test pattern display you can enter from the clock page by short press SCROLL + SELECT/ENTER. All pixels are lit up.</p> <p>The second short press SCROLL + SELECT/ENTER returns to the clock page.</p>
	<p>Present billing period data - general page: period start date and time, period duration in days, and the billing period count (number of maximum demand resets).</p> <p>Extended press SCROLL + SELECT/ENTER is a shortcut for immediate entering the billing maximum demand reset/end of billing period menu.</p>
	<p>Total energy reading of register 1 – imported kWh.</p>







BILL 0 Reg 2/Total 5/51  <b>25706.5</b> kWh exp <small>&lt;07/09/08 13:17&gt; &lt;2.8.0&gt; 123</small>	Total energy reading of register 2 – exported kWh.
BILL 0 Reg 3/Total 6/51  <b>58933.6</b> kvarh imp <small>&lt;07/09/08 13:17&gt; &lt;3.8.0&gt; 123</small>	Total energy reading of register 3 – imported (inductive) kvarh.
BILL 0 Reg 4/Total 7/51  <b>5278.1</b> kvarh exp <small>&lt;07/09/08 13:17&gt; &lt;4.8.0&gt; 123</small>	Total energy reading of register 4 – exported (capacitive) kvarh.
BILL 0 Reg 1/Trf 1 8/51  <b>123726.2</b> kWh imp <small>&lt;07/09/08 13:17&gt; &lt;1.8.1&gt; 123</small>	Tariff 1 energy reading of register 1 – imported kWh.
BILL 0 Reg 1/Trf 2 9/51  <b>31912.5</b> kWh imp <small>&lt;07/09/08 13:18&gt; &lt;1.8.2&gt; 123</small>	Tariff 2 energy reading of register 1 – imported kWh.
...	...
BILL 0 Reg 4/Trf 3 19/51  <b>52.3</b> kvarh exp <small>&lt;07/09/08 13:20&gt; &lt;4.8.3&gt; 123</small>	Tariff 3 energy reading of register 4 – exported kvarh.
BILL 0 Reg 1/Total MAX 20/51  <b>391.784</b> MW imp <small>&lt;07/09/08 13:14&gt; &lt;1.6.0&gt; 123</small>	Total maximum demand reading of register 1 – imported kW.
...	...
BILL 0 Reg 4/Total MAX 23/51  <b>1.906</b> Mvar exp <small>&lt;07/09/08 13:14&gt; &lt;4.6.0&gt; 123</small>	Total maximum demand reading of register 4 – exported kvar.
BILL 0 Reg 1/Trf 1 MAX 24/51  <b>391.784</b> MW imp <small>&lt;07/09/08 13:14&gt; &lt;1.6.1&gt; 123</small>	Tariff 1 maximum demand reading of register 1 – imported kW.
...	...
BILL 0 Reg 4/Trf 3 MAX 35/51  <b>0.794</b> Mvar exp <small>&lt;06/09/08 13:07&gt; &lt;4.6.3&gt; 123</small>	Tariff 3 maximum demand reading of register 4 – exported kvar.
BILL 0 Reg 1/Total CUM 36/51  <b>1060.686</b> MW imp <small>&lt;01/09/08 00:00&gt; &lt;1.2.0&gt; 123</small>	Total cumulative maximum demand reading of register 1 – imported kW.
...	...

BILL 0 Reg 4/Total CUM 39/51 <input type="checkbox"/> <b>239.061</b> MVar exp T1 (01/09/08 00:00) (4.2.0) 123	Total cumulative maximum demand reading of register 4 – exported kvar.
BILL 0 Reg 1/Trf 1 CUM 40/51 <input type="checkbox"/> <b>1060.686</b> MW imp T1 (01/09/08 00:00) (1.2.1) 123	Tariff 1 cumulative maximum demand reading of register 1 – imported kW.
...	...
BILL 0 Reg 4/Trf 3 CUM 51/51 <input type="checkbox"/> <b>2.967</b> MVar exp T1 (01/09/08 00:00) (4.2.3) 123	Tariff 3 cumulative maximum demand reading of register 4 – exported kvar.

### Previous Billing Period Data

The following example demonstrates billing displays for the three previous billing periods. Displays for the last billing period (BILL 1) and for two preceding billing periods (BILL 2) and (BILL 3) look the same.

BILL 1 (LAST PERIOD) 1/49 <input type="checkbox"/> 01/08/08 00:00 T1 TO 01/09/08 00:00 (0.1.2x1) 123 DAYS 31 (0.8.6x1) 123	Previous billing period data - general page: period start date and time, period end date and time, and period duration in days.
BILL 1 Reg 1/Total 2/49 <input type="checkbox"/> <b>129043.2</b> kWh imp T1 (01/09/08 00:00) (1.8.0x1) 123	Total energy reading of register 1 – imported kWh.
BILL 1 Reg 2/Total 3/49 <input type="checkbox"/> <b>4144.8</b> kWh exp T1 (01/09/08 00:00) (2.8.0x1) 123	Total energy reading of register 2 – exported kWh.
...	...
BILL 1 Reg 1/Trf 1 6/49 <input type="checkbox"/> <b>100300.9</b> kWh imp T1 (01/09/08 00:00) (1.8.1x1) 123	Tariff 1 energy reading of register 1 – imported kWh.
BILL 1 Reg 1/Trf 2 7/49 <input type="checkbox"/> <b>19701.2</b> kWh imp T1 (01/09/08 00:00) (1.8.2x1) 123	Tariff 2 energy reading of register 1 – imported kWh.
...	...
BILL 1 Reg 1/Total MAX 18/49 <input type="checkbox"/> <b>353.578</b> MW imp T1 (31/08/08 23:57) (1.6.0x1) 123	Total maximum demand reading of register 1 – imported kW.











BILL 1 Reg 2/Total MAX 19/49  <b>66.459</b> MW exp T1 H <05/08/08 11:05> <2.6.0x1> 123	Total maximum demand reading of register 1 – exported kW.
...	...
BILL 1 Reg 1/Trf 1 MAX 22/49  <b>353.578</b> MW imp T1 H <31/08/08 23:57> <1.6.1x1> 123	Tariff 1 maximum demand reading of register 1 – imported kW.
BILL 1 Reg 1/Trf 2 MAX 23/49  <b>70.728</b> MW imp T1 H <01/08/08 08:03> <1.6.2x1> 123	Tariff 2 maximum demand reading of register 1 – imported kW.
...	...
BILL 1 Reg 1/Total CUM 34/49  <b>707.108</b> MW imp T1 H <01/09/08 00:00> <1.2.0x1> 123	Total cumulative maximum demand reading of register 1 – imported kW.
BILL 1 Reg 2/Total CUM 35/49  <b>170.384</b> MW exp T1 H <01/09/08 00:00> <2.2.0x1> 123	Total cumulative maximum demand reading of register 1 – exported kW.
...	...
BILL 1 Reg 1/Trf 1 CUM 38/49  <b>707.108</b> MW imp T1 H <01/09/08 00:00> <1.2.1x1> 123	Tariff 1 cumulative maximum demand reading of register 1 – imported kW.
...	...
BILL 1 Reg 4/Trf 3 CUM 49/49  <b>2.954</b> Mvar exp T1 H <01/09/08 00:00> <4.2.3x1> 123	Tariff 3 cumulative maximum demand reading of register 4 – exported kvar.

## Engineering Maximum Demand Data Display



Maximum demand displays show engineering maximum demands (not billing maximum demands) for powers, voltages, currents and total harmonics. Each quantity is displayed with the date and time of the last update.

From any maximum demand display, you can use an extended press SCROLL + SELECT/ENTER as a shortcut for immediate entering the corresponding maximum demand reset menu.

MAX. DEMAND 1/18  P imp 223.659 MW T1 H <07/09/08 13:55:00> 123	kW import maximum demand
--	--------------------------



















MAX. DEMAND 2/18  Q imp 96.278 Mvar # <07/09/08 14:07:00> ---	kvar import (inductive) maximum demand
MAX. DEMAND 3/18  S 329.513 kVA H <07/09/08 17:13:00> 123	kVA maximum demand
MAX. DEMAND 4/18  P exp 49.854 MW H <07/09/08 14:03:00> 123	kW export maximum demand
MAX. DEMAND 5/18  Q exp 5.506 Mvar H <07/09/08 14:03:00> 123	kvar export (capacitive) maximum demand
MAX. DEMAND 6/18  U1 63.00 kV H <07/09/08 14:00:00> 123	V1 maximum demand Indicate V12 voltage in line-to-line configurations.
...	...
MAX. DEMAND 8/18  U3 62.51 kV H <07/09/08 14:00:00> 123	V3 maximum demand Indicate V31 voltage in line-to-line configurations
MAX. DEMAND 9/18  I1 1201.5 A H <07/09/08 13:53:00> 123	I1 maximum demand
...	...
MAX. DEMAND 12/18  I4 15.63 A H <07/09/08 14:54:00> 123	I4 maximum demand
MAX. DEMAND 13/18  U1 THD 1.3 % H <01/06/08 09:15:00> 123	V1 THD maximum demand
...	...
MAX. DEMAND 15/18  U3 THD 1.3 % H <01/06/08 09:15:00> 123	V3 THD maximum demand
MAX. DEMAND 16/18  I1 THD 0.5 % H <01/06/08 09:15:00> 123	I1 THD maximum demand
...	...



<b>MAX. DEMAND</b> 18/18  <b>I3 THD</b> 0.5%  <01/06/08 09:15:00> 123	I3 THD maximum demand
---	-----------------------

## Engineering Data Display

Engineering data represent general instrumentation data you can use while installation and inspecting the meter. Use phase angles displays to check the order of phases when connecting wires to the meter terminals.

<b>ENGINEERING</b> 1/14  <b>U1</b> 63.04 kV <b>U2</b> 62.96 kV  <b>U3</b> 62.58 kV 123	Phase-to-neutral voltages. Only displayed in 4-wire configurations with a neutral.
<b>ENGINEERING</b> 2/14  <b>U12</b> 110.1 kV <b>U23</b> 110.0 kV  <b>U31</b> 109.3 kV 123	Phase-to-phase voltages
<b>ENGINEERING</b> 3/14  <b>I1</b> 1201.62 A <b>I2</b> 1202.46 A  <b>I3</b> 1199.93 A 123	Phase currents
<b>ENGINEERING</b> 4/14  <b>I4</b> 2.40 A <b>I<sub>n</sub></b> 4.78 A  <b>Freq</b> 50.17 Hz 123	Auxiliary current Neutral current Frequency
<b>ENGINEERING</b> 5/14  <b>P</b> 391.775 MW <b>S</b> 391.780 MVA  <b>Q</b> -1.913 Mvar 123	Total powers
<b>ENGINEERING</b> 6/14  <b>PF</b> 1.000 <b>V<sub>unb</sub></b> 0%  <b>I<sub>unb</sub></b> 0% 123	Total power factor Voltage unbalance, % Current unbalance, %
<b>ENGINEERING</b> 7/14  <b>U1 THD</b> 0.6% <b>U2 THD</b> 0.6%  <b>U3 THD</b> 0.6% 123	Phase voltage THD Indicate phase-to-phase voltage THD in line-to-line configurations
<b>ENGINEERING</b> 8/14  <b>I1 THD</b> 0.3% <b>I2 THD</b> 0.2%  <b>I3 THD</b> 0.2% 123	Phase current THD
<b>ENGINEERING</b> 10/14  <b>U1 Pst</b> 0.48 <b>U2 Pst</b> 0.50  <b>U3 Pst</b> 0.48 123	Short-term flicker

<pre>ENGINEERING      11/14 [ ] U1 P1t  0.48 U2 P1t  0.50      H U3 P1t  0.48      123</pre>	Long-term flicker
<pre>ENGINEERING      12/14 [ ] U1          0° U2        -120.9°      H U3        119.8°      123</pre>	Voltage phase angles (relative to V1 voltage). Indicate phase-to-phase voltage angles in line-to-line configurations.
<pre>ENGINEERING      13/14 [ ] I1         -1.8° I2        -122.1°      H I3         118.7°      123</pre>	Phase current phase angles (relative to V1 voltage)
<pre>ENGINEERING      14/14 [ ] I4         -3.2°            H            123</pre>	Auxiliary current phase angle (relative to V1 voltage)

## Setup Data Display

The setup data display shows basic device settings that can be required for immediate inspecting while meter testing and at the time of installation.

<pre>SETUP            1/3 [ ] Wiring          4LH3 PT Ratio        1000.0      H Nom. Voltage    110V L-L    123</pre>	Device wiring mode (see <a href="#">Basic Meter Setup</a> for full list of wiring modes), external potential transformer ratio and the nominal device voltage.
<pre>SETUP            2/3 [ ] CT Primary      1200 CT4 Primary     1200      H Nom. Freq.      50 Hz      123</pre>	Primary ratings of the external current transformers (main and auxiliary current inputs) and the nominal device frequency.
<pre>SETUP            3/3 [ ] Pow. Dmd Per.  1x15 min Volt Dmd Per.   900 s      H Amp. Dmd Per.   900 s      123</pre>	Power demand period (number of blocks x block demand period), and voltage and ampere demand periods.

## Device Info Display

The device info display provides different service information that may be required for meter identification and inspection, like product and firmware information, batteries status, operation time, communication settings, and so on.



### NOTE

Always clear the meter operation time and fault counters before putting the meter into operation. Clear the battery operation time counters after replacing a battery. See [Resetting Accumulators and Clearing Log Files](#) in Chapter 6 for information on how to clear the operation and fault counters in your meter.

<pre> DEVICE INFO          1/10 [ ] Device S/H          00123456 Product.date (20/06/10) [H] Calibrated (20/06/10) 123 </pre>	Meter identification info: serial number, production date and calibration date
<pre> DEVICE INFO          2/10 [ ] Operation beg. (28/06/10) Operation time      5879 h [H] Out of service      2.4 h 123 </pre>	Meter operation time counters (since start of operation): Start of operation date Total operation time in hours Out of service time in hours
<pre> DEVICE INFO          3/10 [ ] Power failures      3 Interruptions       8 [H] Internal Temp.     31.0°C 123 </pre>	Power failure counters (since start of operation): Total number of power failures Total number of 3-phase voltage interruptions Internal meter temperature
<pre> DEVICE INFO          4/10 [ ] Lithium battery     OK Battery date (28/06/10) [H] Operation time      2.4 h 123 </pre>	Lithium battery status and operation time: Battery status Battery replacement date Total operation time
<pre> DEVICE INFO          5/10 [ ] Aux. battery        8.24 V Battery date (28/06/10) [H]                    123 </pre>	Auxiliary battery status and operation time: Battery status and voltage Battery replacement date
<pre> DEVICE INFO          6/10 [ ] Firmware            V26.1.7 Cop                 V27.1.3 [H] Boot                V1.1.2 123 </pre>	Meter firmware information: Host processor firmware version Fast transient coprocessor firmware version Host boot loader firmware version
<pre> DEVICE INFO          7/10 [ ] Program Flash       1024K Data Flash          16384K [H]                    123 </pre>	Memory information: Program flash memory size Data flash memory size
<pre> DEVICE INFO          8/10 [ ] COM1 1,19.2,IEC 62056-21 COM2 1,GPRS [H] COM3 1,19.2,Modbus RTU 123 </pre>	Serial communication ports info: network address, baud rate and communication protocol.
<pre> DEVICE INFO          9/10 [ ] MAC                 0005F0000091 IP Address          192.168.0.203 [H] Gateway             192.168.0.1 123 </pre>	Ethernet network info: Device MAC address Network IP address Default gateway IP address
<pre> DEVICE INFO          10/10 [ ] GPRS IP             10.171.18.237 GPRS RSSI           -63 dBm [H]                    123 </pre>	Wireless GPRS network info: Network IP address Receive signal strength indicator (RSSI), dBm

## Device Diagnostics Display

The diagnostics display shows device diagnostic messages recorded as a result of the meter self-test diagnostics during start-up and operation.

<pre>DIAGNOSTICS: 3 msg 1/1  1: Power down 2: Magnet. interference  3: Motion/tilt sensor 123</pre>	<p>If there are more pages, use a short press on the SCROLL button to scroll through the entire list of messages.</p> <p>Extended press SCROLL + SELECT/ENTER is a shortcut for immediate entering the diagnostics reset menu.</p>
---	--

If there are diagnostic messages, the **(i)** diagnostic icon at right on the display flashes until you clear the device diagnostics. Some of the diagnostics events are cleared automatically as the event source disappears. See [Device Diagnostic Codes](#) in Appendix G for a full list of diagnostic messages and their meanings. See [Clearing Device Diagnostics](#) for information on how to clear the device diagnostics from the display and via PAS.

The diagnostic icon can be disabled or enabled via the [Display Setup](#) menu.

## Programming Mode

To enter programming mode from the data display, press and hold the SELECT/ENTER button for more than 5 seconds.

## Navigation Buttons

The following table gives a summary of the button operations in programming mode.

Button	Press	Operations
SCROLL	Short press	Scroll through a menu item list in a highlighted window or increment a highlighted digit in a numeric field
SELECT/ENTER	Short press (less than 1 second) = SELECT	Highlight a menu window or a digit in a numeric field
SELECT/ENTER	Long press (1 to 2 seconds) = ENTER	Store the changed item or perform an action indicated in a highlighted window

## Entering Numeric Values

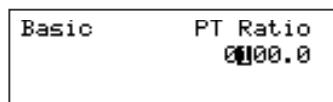

Basic PT Ratio  
0100.0

SELECT  SHORT PRESS

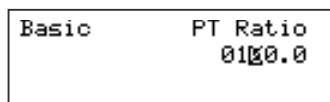

Basic PT Ratio  
010.0

SCROLL 

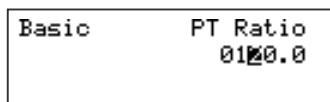

Basic PT Ratio  
0100.0

ENTER  LONG PRESS

Whenever a numeric value is to be changed, use a short press on the SELECT/ENTER button to highlight a desired digit, and then use the SCROLL button to change the value of the highlighted digit. A highlighted digit appears in inversed color. If you missed a digit, just continue moving through the rest of digits until you reach the desired place.

Once the number is set to the desired value, press and hold the SELECT/ENTER button for 1-2 seconds to save your new setting.

To reject your changes and restore the previous value, use a short press on the SELECT/ENTER button to return to the higher-level window.

## Password Security

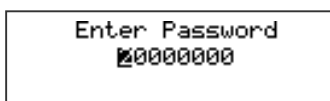

Enter Password  
00000000

SELECT  SHORT

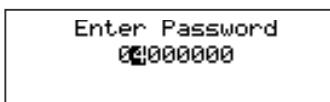

Enter Password  
00000000

ENTER  LONG PRESS

The setup menus are secured by 8-digit user passwords. Every time you enter programming mode, you are prompted for a correct password. The meter is primarily shipped with all passwords preset to 9 at the factory. See [Meter Security](#) in Chapter 2 for more information on the meter security levels.

It is recommended that you change the factory set passwords as fast as possible to protect your setups and accumulated data from unauthorized changes. See [Configuring Meter Passwords](#) in Chapter 5 on how to change passwords in your meter.

Enter the password as you enter numeric values. As you move to the next place, the digit entered is saved and then zeroed. If you missed a digit, you should re-type all preceding digits before you reach the missed place again.

Once the password is set to the desired value, press and hold the SELECT/ENTER button for more than 1 second. If the password you entered is correct, you move to the main device menu, otherwise you return back to the data display.

## Setup Menus and Access Rights

The EM720 setup is menu-driven. The meter provides 12 menus that allow local accessing a limited number of meter setups and control functions listed in the following table. Access to particular menus is granted depending on the security level of the password you entered.

Menu Label	Menu Function	Security Level	
		View	Change
Reset	Reset of billing and engineering maximum demands, device diagnostics, meter and battery operation time counters and failure counters	Low	See Table below
RTC	RTC clock setup	Low	Low
Display	Display setup	Low	Low
Test	TEST/NORMAL mode switching and LED pulse rate setup for TEST mode	Low	Medium
Basic	Basic device setup	Low	High
Options	Device options setup	Low	High
COM1	COM1 serial port setup	Low	Medium
COM2	COM2 serial port setup	Low	Medium
COM3	COM3 serial port setup	Low	Medium
Net	Ethernet network setup	Low	Medium
Local	Local settings	Low	Medium
Access	Meter passwords setup	High	High
Loader	Launches flash download via a local serial port	Medium	Medium

Access to the RESET menu entries is allowed depending on your security level as shown in Section [Resetting Accumulators and Log Files](#) in Chapter 6.

If your security level does not allow access to a menu, it will not be listed in the main menu list, and you will not be able to highlight menu items that you are not allowed to change, but you can still view their present settings.

## Viewing and Changing Setup Options

Once you entered a correct password you are moved to the main meter menu.

The main menu has two windows: the left window displays a submenu list, while the right window is an assisting Exit window that allows easy returning back to the data display. A currently active menu item is highlighted by inversed color.

### To select a desired menu entry from the menu list:

1. If the left window is not highlighted yet, highlight it by briefly pressing the SELECT/ENTER button.
2. Use the SCROLL button to scroll through the menu list until the desired menu entry appears.
3. Press the SELECT/ENTER button for more than 1 second to enter the selected submenu.

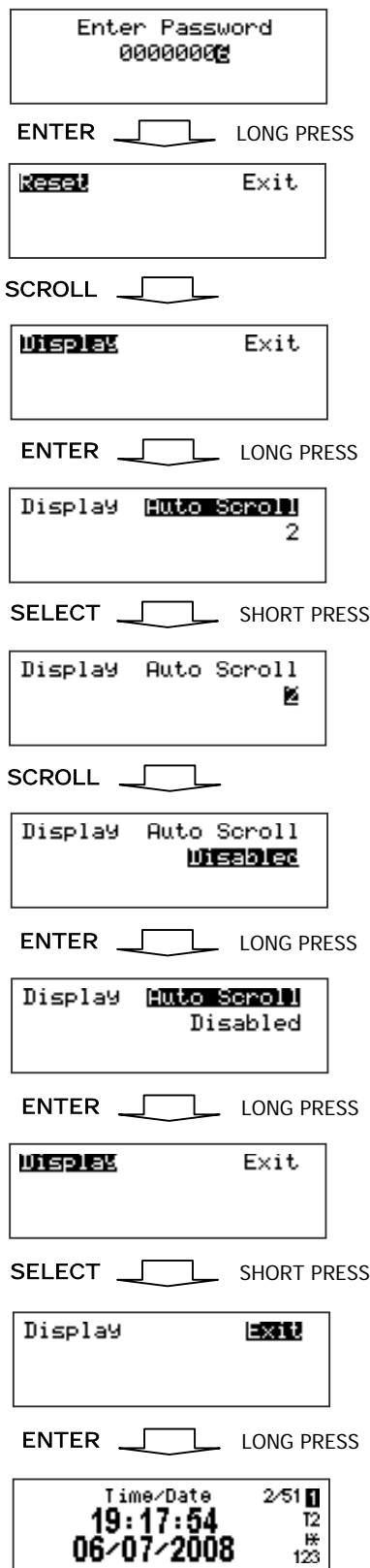

Once you entered a submenu, the left window is still showing the menu name, while the upper-right window represent a submenu options list, and the lower-right window indicates the present option value.

#### To select an option you want to view or change:

Use the SCROLL button to scroll through the option list until the desired option's name appears in the window.

#### To change the selected option's value:

1. Press the SELECT/ENTER button briefly to highlight the lower-right window.
2. If an option is represented by a list of values, use the SCROLL button to scroll through the list until a desired value appears in the window. If an option is represented by a numeric value, use the SCROLL button to adjust each digit to the desired value, and use a short press on the SELECT/ENTER button to move through digits.
3. Once the desired value is selected, press the SELECT/ENTER button for more than 1 second to save your new setting. You return to the upper-right window and can continue scrolling through the rest of options or can return to the main menu.

If you wish to leave the option value unchanged, use a short press on the SELECT/ENTER button to return to the upper-right window.

#### To exit the submenu and return to the main menu:

1. If the upper-right window is not highlighted yet, highlight it by briefly pressing the SELECT/ENTER button.
2. Press the SELECT/ENTER button for more than 1 second. You will return to the main menu.

#### To exit the main menu and return to the data display:

1. Press briefly the SELECT/ENTER button to highlight the right-upper Exit window.
2. Press the SELECT/ENTER button for more than 1 second. You will return back to the data display.

## Chapter 4 Using PAS Software

The support PAS software is a configuration and data acquisition tool that allows you to configure all of the EM720 features, monitor your meter on-line, retrieve recorded files and view reports. PAS can communicate with your meter via any communication interface installed in your meter, including the embedded infrared port, serial ports, and the Ethernet and wireless GSM/GPRS communications.

This chapter gives information on how to install and run PAS on your computer, and how to prepare information for your meter using PAS. See Chapter 5 [Configuring the EM720](#) for instructions on how to configure particular features in your EM720. Refer to Chapters 7 and 8 for instructions on retrieving data from your meter and viewing reports.

### NOTE

PAS uses the Modbus RTU or Modbus TCP protocol for communicating with the EM720. If you connect your PC to the EM720 via a serial infrared or RS-232/RS-485 port, ensure that the port is set to the Modbus RTU mode.

## Software Installation

### Installing PAS



PAS

You need PAS V1.4 or higher to work with the EM720.

#### To install PAS on your PC:

1. Insert the installation CD supplied with your EM720 into CD drive.
2. Open My Computer on your Desktop.
3. Click on your CD drive icon, select the PAS directory, and then double click on Setup (shown as an Application type file).
4. Follow InstallShield® Wizard instructions on the screen.

PAS is installed by default to the C:\Program Files\Pas folder. If your user account rights do not allow writing to the C:\Program Files\ folder, change the PAS default installation folder to another folder to avoid possible ODBC security problems when running PAS.

When installation is complete, the PAS icon appears on your Desktop. Double click on the PAS icon to run PAS.

For general information on how to work with PAS, see the "PAS Getting Started" guide supplied on the installation CD.

### Installing the USB Driver

To take an advantage of the USB communications, install the EM720 USB driver on your PC.



Connect the EM720 to your PC's USB port using the supplied USB cable. When the EM720 is powered up, Windows automatically detects the meter and launches the hardware installation wizard. The following example demonstrates an installation of the USB driver on Windows XP.

1. The "Found New Hardware Wizard" dialog box is displayed as follows.

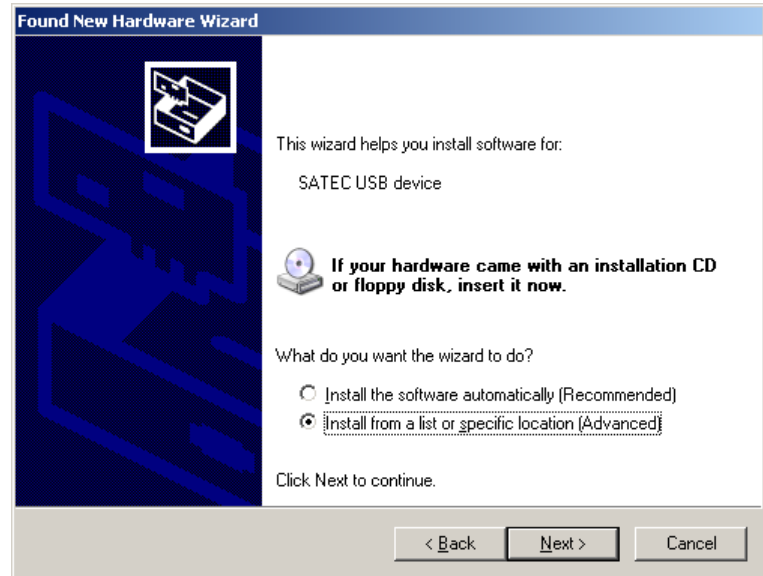

2. Select "Install from a list or specific location" and click "Next".

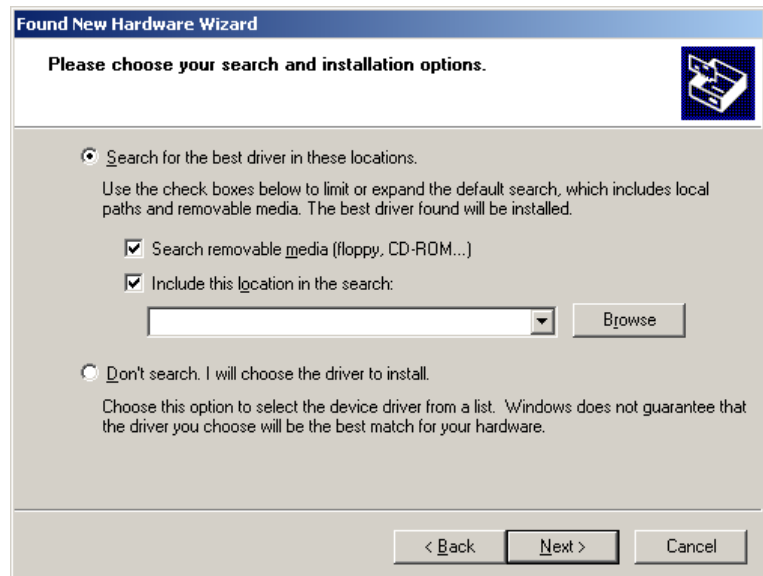

3. Click "Browse".

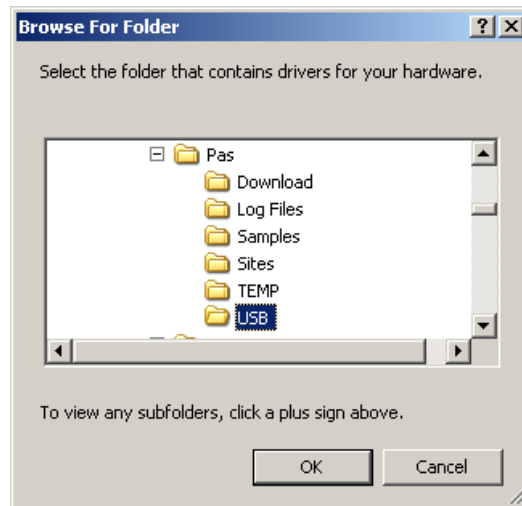

4. Point to the "USB" folder located in the PAS installation directory and click "OK"

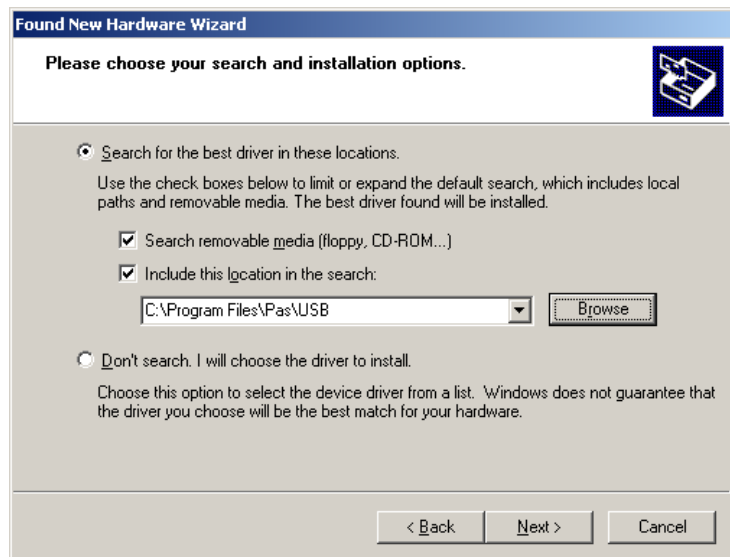

5. Click "Next".



6. Click "Finish" to complete installation.

The next time you power up the EM720 or connect it to your PC with the USB cable, Windows automatically launches the driver for your meter.

## Creating a New Site for your Meter

PAS keeps all communication and configuration data for your meter in a configuration database called a site database. During configuration store all setup data to the site database so that PAS recognizes device properties regardless of whether your meter is online or offline.

**To create a new database for your meter:**

1. Select Configuration from the Tools menu.

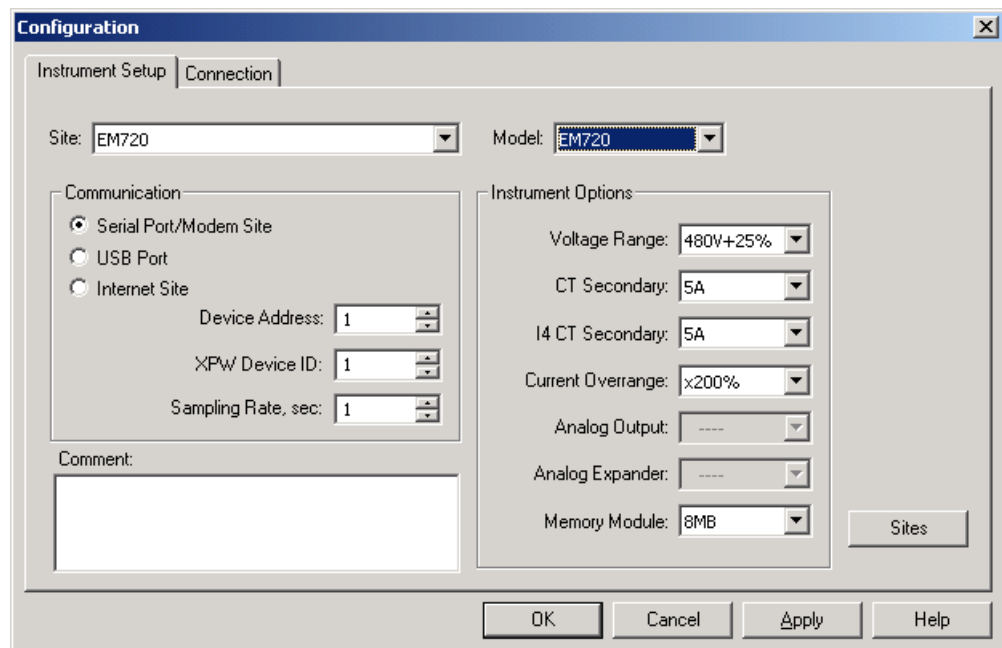

2. Click the Sites button on the right-hand-side.

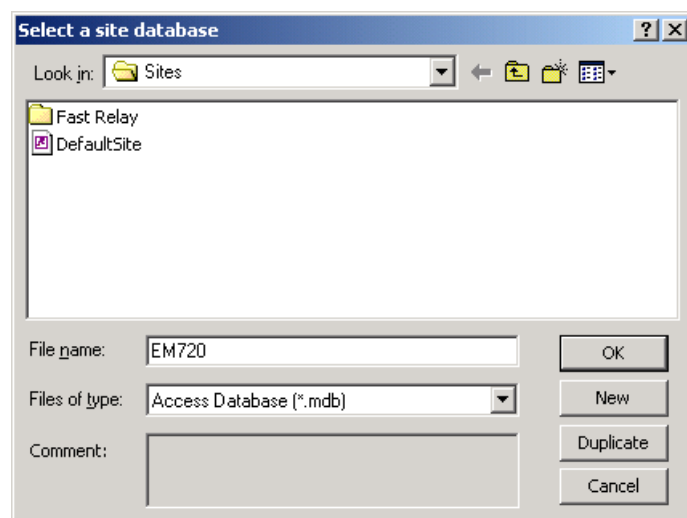

3. From the "Look in" box, select the directory where a new database will be stored. By default, it will be the

“Sites” directory. Type a site name for your device in the “File name” box, click New, and then click OK.

4. On the Instrument Setup tab, select “EM720” in the “Model” box. PAS automatically selects the appropriate instrument options for your meter.
5. Select a correct CT secondary current (5A or 1A) for your meter.
6. If you wish to add any comments for your meter, type them into the “Comment” box.

## Setting up Communications

You can communicate with your meters via a PC RS-232 serial port, through the Internet, via either a local Ethernet, or a wireless GPRS Dial-Up connection, and via the USB port.

### To configure your communications with the EM720:

1. Select Configuration from the Tools menu. Under the Communication group on the Instrument Setup tab, select the type of connection for your device.
2. Set the device communication address you assigned to the EM720 port. When communicating via the Ethernet or a GPRS modem, the EM720 responds to any address you select.
3. In the “Sampling Rate” box, select a rate at which PAS updates data on your screen when you continuously poll the device in the PAS Data Monitor.

The communication protocol and port settings must match the settings you made in your meter.

## Communicating through a Serial Port

Select Serial Port/Modem Site on the Configuration tab, and then click on the Connection tab to configure your serial port settings.

### Configuring a Serial Port

1. On the Connection tab, select a COM port from the “Device” box, and then click Configure.

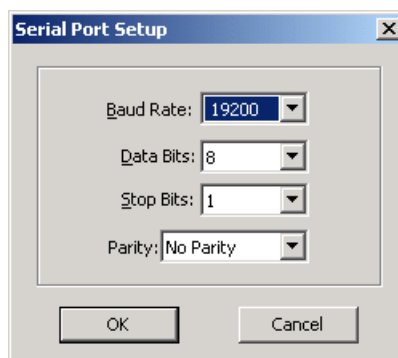

2. Specify the baud rate and data format for the port. Choose the same baud rate and data format as you have set in the meter, and then click OK.

### Selecting the Communications Protocol

1. On the Connection tab, click Protocol.

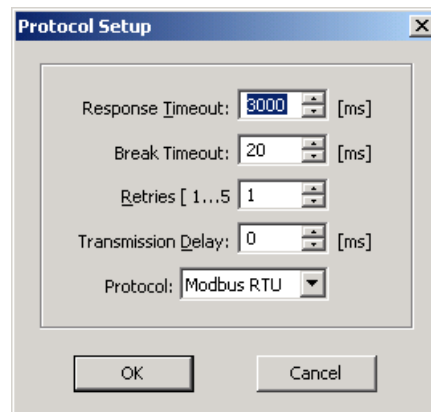

2. In the "Protocol" box, select the same communications protocol as you have set in your device.
3. The remaining settings in this dialog do not normally need to be changed.
4. In the "Response Time-out" box, define the maximum time that PAS should wait for the meter response before announcing a failure. When communicating through a GPRS modem, this time may require some adjustment.
5. In the "Break Time-out" box, define the maximum character idle time that PAS should wait after receiving the last message character to close a connection when using the Modbus RTU or DNP3 protocol. It does not affect Modbus ASCII communications. If there are many applications running on your PC, PAS might be prevented from responding to received characters fast enough and may close the communication while the device is still transmitting. If you frequently receive the "Communication error" message, try to increase "Break Time-out". This time is added to the message transfer time, and excessive increasing it may slow down communications.
6. In the "Retries" box, define the number of attempts that PAS should use to receive a response from the meter in the event the communication fails, before announcing a communication failure.

### Communicating through the Internet

If you are communicating through the Ethernet port, define the IP address of your meter on the network.

1. On the Instrument Setup tab, select Internet Site.
2. Click on the Connection tab.
3. Click on the "IP address" and type in the IP address of your meter. The default meter IP address preset at the factory is 192.168.0.203.

4. In the "Protocol" box, select the communications protocol for the TCP port. The meter provides Modbus/TCP connections on TCP port 502 and DNP3/TCP connections on port 20000. The host port is set automatically as you select the protocol. Select "Modbus RTU/TCP" for Modbus/TCP or "DNP3" for DNP3/TCP.
5. In the "Wait for answer" box, adjust the time that PAS waits for a connection before announcing an error and the number of retries PAS uses to receive a response from the device if communications fail.

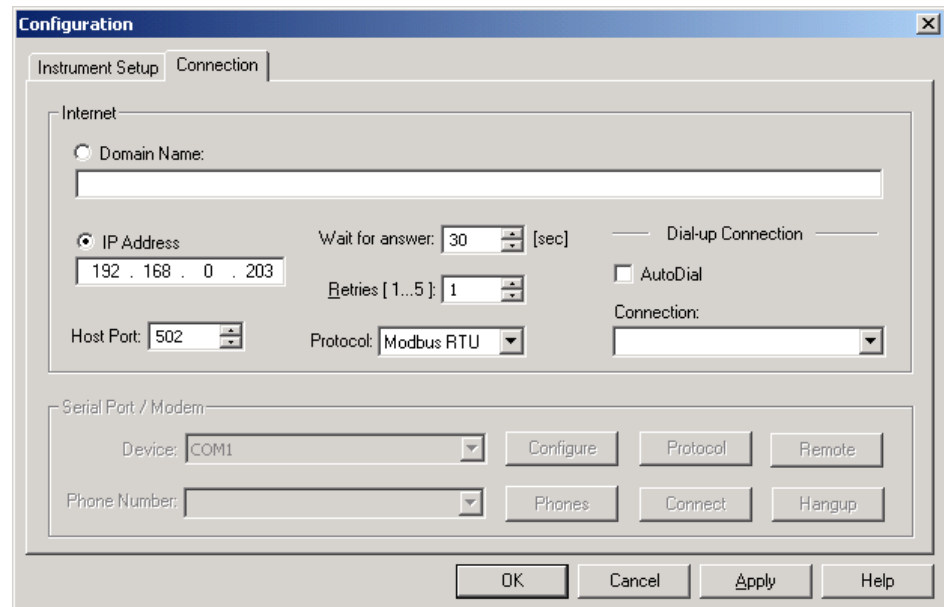

## Communicating through a GSM/GPRS Modem

You should use Windows Dial-Up networking to access the EM720 via your wireless GSM/GPRS modem.

See your local GSM/GPRS modem manual and Windows help on how to create a new Dial-Up PPP connection for your GPRS modem.

### Configuring a Dial-up GPRS Connection

#### To communicate through a GPRS modem:

1. On the Instrument Setup tab, select Internet Site.
2. Click on the Connection tab.

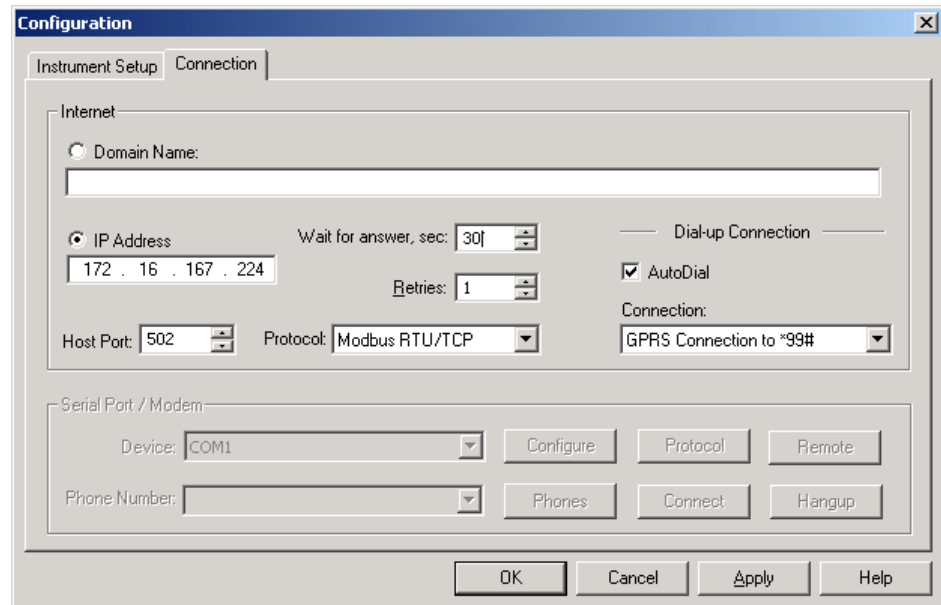

```

DEVICE INFO          9:9
GPRS IP      172.16.175.80
GPRS RSSI    -79 dBm

```

3. Click on the "IP address" and type in the IP address your meter got from the GPRS provider when registering on the GPRS network. You can find the meter GPRS IP address on the GPRS page in the Device Info display (see [Device Info Display](#) in Chapter 3) or via the Dial-Up Networking setup dialog in PAS (see Modem/GPRS IP Address in [Setting-Up Dial-Up GPRS Network](#) in Chapter 5)
4. In the "Protocol" box, select the communications protocol for the EM720 GPRS TCP port. The host port is set automatically as you select the protocol. Select "Modbus RTU/TCP" for Modbus/TCP, or "DNP3" for DNP3/TCP.
5. In the "Wait for answer" box, adjust the time that PAS should wait for a connection before announcing an error and the number of re-tries that PAS should use to receive a response from the device if communications fail.
6. In the "Connection" box, select the Dial-up connection you created for the EM720. See Dial-Up Networking for information on how to create a Dial-up connection in Windows.
7. Check the AutoDial box, if you wish PAS to automatically connect to your meter every time you access it from PAS; otherwise you must manually dial your connection.

### Manual Dialing your Connection

#### To manually dial your GPRS connection:

1. Select your connection name from the Start menu -> Settings -> Network and Dial-Up Connections.



2. Click Dial.

## Communicating through a USB

On the Instrument Setup tab, click USB Port, and then click OK.



## Setting Up the Meter

PAS allows you to prepare setup data for your meter off-line without the need to have it connected to your PC.

### To prepare a setup for your meter:

1. Select the device site from the list box on the PAS toolbar.
2. Select the desired setup group from the Meter Setup menu. Click on the tab with the setup you want to create or modify.
3. Fill in the boxes with the desired configuration data for your meter.
4. Click the "Save as..." button to store the data to the meter site database.
5. Click OK.

### NOTE

Always set up and store the Basic Setup data to the site database first. PAS uses this data as a reference when arranging other meter setups.

### To save your setup to another site database:

1. Click the "Save as..." button.
2. Select the target database from the file pane.
3. Click OK.

You can also reuse a setup from another site by copying it to your present site database.

### To copy a setup from another site's database:

1. Click Open.
2. Select the desired source site database.
3. Click OK. The opened setup is copied to your dialog window.
4. Click the "Save as..." button.
5. Select the target database from the file pane.
6. Click OK.

### To copy all setups from one site database to another site's database:

1. In the list box on the toolbar, select a source device site from which you wish to copy setups.
2. Select "Copy to..." from the Meter Setup menu.
3. Select the target site database to which you wish to copy setups, and click OK.

## Downloading Setups to the Meter

You can update each setup in your meter one at a time or download all setups together from the site database.

### Individual Download

To update a particular setup in your meter:

1. Check the On-line button on the PAS toolbar
2. Select a meter site from the list box on the toolbar.
3. Select the desired setup group from the Meter Setup menu. Click on the setup tab you want to download to the meter. As the setup dialog box opens, PAS retrieves and displays the present meter setup data.
4. If you wish to download a setup saved in the site database, click Open, and then click OK, or fill in the boxes with the desired configuration data for your device.
5. Click Send.

### Batch Download

To download all setups to your device at once:

1. Check the On-line button on the toolbar
2. Select the device site from the list box on the toolbar.
3. Select Download Setups from the Meter Setup menu.

### NOTE

The passwords setup is not downloaded via the Batch Download. You can only download it individually via the Administration Setup/Passwords dialog (see [Configuring Meter Passwords](#) in Chapter 5).

## Uploading Setups from the Meter

### Individual Upload

To get a particular setup from your device;

1. Check the On-line button on the PAS toolbar.
2. Select a meter site from the list box on the toolbar, and then select the desired setup group from the Meter Setup menu.
3. Click on the tab of the setup you want to read from the meter. As the dialog box opens, PAS retrieves and displays the present setup data from the meter. Click Receive if you wish to retrieve the meter setup once again.
4. To store the setup to the meter site database, click Save As, and then click OK.

### Batch Upload

To upload all setups from the device to the site database at once:

1. Check the On-line button on the toolbar.

2. Select the device site from the list box on the toolbar.
3. Select Upload Setups from the Meter Setup menu.

**NOTE**

The passwords setup is never uploaded via the Batch Upload and may not be read from the meter. When you open the Passwords setup dialog, all passwords are zeroed.

## Authorization and Security

Every time you try to send the setup data to the meter, you are prompted for the password.

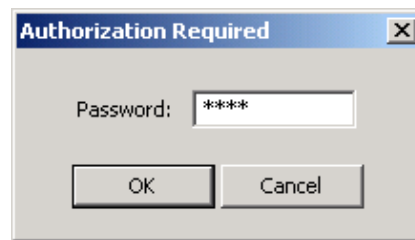

Enter the password and click OK. If your authorization was successful, you are not prompted for the password again until you close the dialog window.

See [Meter Security](#) in Chapter 2 for more information on the meter password security.

## Chapter 5 Configuring the EM720

This chapter describes how to configure the EM720 for your particular environment and application from the front display and via PAS. To access your meter configuration options via PAS, you should create a site database for your device as shown in Chapter 4.

### Configuring Communications

#### Setting Up Serial Communication Ports

##### Using the Front Display

```
COM1      Protocol
          IEC 62056-21
```

Select COM1 through COM3 from the main menu. See [Viewing and Changing Setup Options](#) in Chapter 3 for information on navigating in menus.

See the table below for available communication options.

##### Using PAS

Select Communications Setup from the Meter Setup menu, and then click on the Serial Ports Setup tab. In the Port box, select the desired device port.

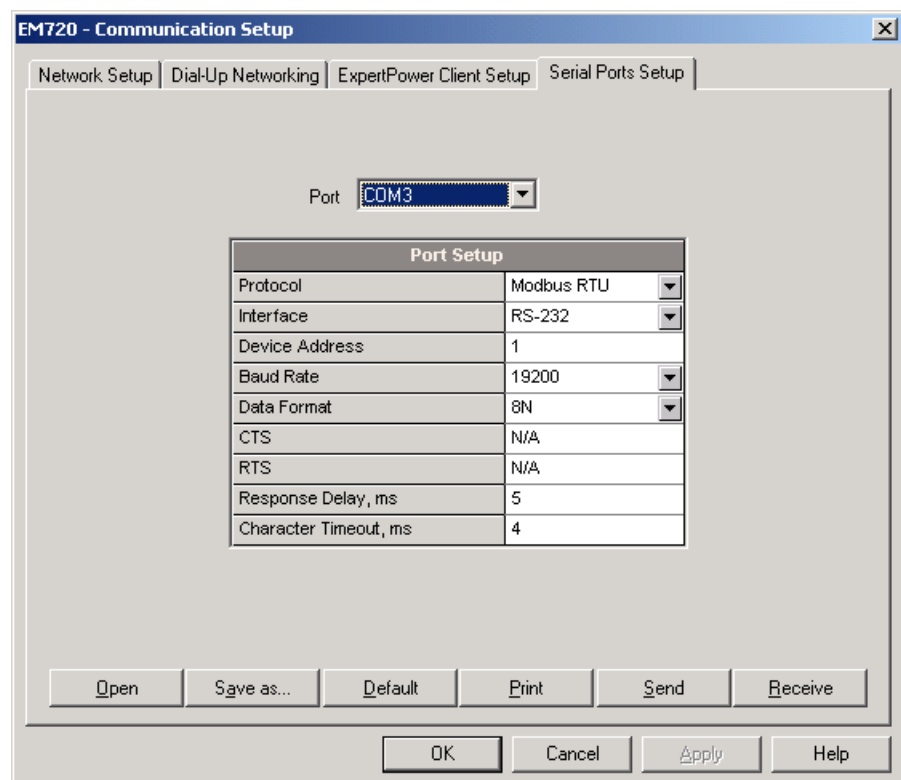

To change the port settings in your device, select desired port parameters, and then click Send.

The following table lists available port options.

Display Label	Parameter	Options	Default	Description
Protocol	Communication protocol	Modbus RTU, Modbus ASCII, DNP3, IEC 62056-21	IEC 62056-21 (COM1) Modbus RTU (COM 3)	The communications protocol for the port
Interface	Port interface	RS232, RS485, IR, GPRS	IR (COM1) GPRS (COM2) RS485 (COM3)	Not changeable; automatically detected by the meter
Address	Device address	Modbus: 1-247 DNP3: 0-65532 IEC 62056-21: 0-65532	1	Device network address
Baud Rate	Baud rate	COM1: 300-19200 kbps, COM2-3: 300-115.2 kbps	19.2 kbps	The port baud rate
Data/Parity	Data format and parity	7E, 8N, 8E	8N	7E data format should not be used with the Modbus RTU and DNP3 protocols
Send Delay	Response delay	0-1000 ms	5 ms	The minimum time after the last request character is received to start the transmission.
Chr.Timeout	Character timeout	0-1000 ms	4 ms	The maximum time the line is allowed to idle before closing a connection in the Modbus RTU and DNP3 protocols

The meter automatically detects replaceable communication modules and does not allow you to change the baud rate and data format for the Dial-up GSM/GPRS modem.

## Setting Up the Ethernet

### Using the Front Display

```

Net.      IP ADDRESS
192.168.000.203
  
```

Select Net from the main menu. See [Viewing and Changing Setup Options](#) in Chapter 3 for information on navigating in menus.

See the table below for available network options.

### Using PAS

Select Communications Setup from the Meter Setup menu, and then click on the Network Setup tab.

Current Network Settings	
Ethernet IP Address	192 . 168 . 0 . 203
Ethernet Subnet Mask	255 . 255 . 255 . 0
Ethernet Default Gateway	192 . 168 . 0 . 1
MAC Address	0005F0001E48

Network Setup	
Device IP Address	192 . 168 . 0 . 203
Network Subnet Mask	255 . 255 . 255 . 0
Network Default Gateway	192 . 168 . 0 . 1
Use DHCP	----
TCP Service Port	----
Primary DNS IP Address	0 . 0 . 0 . 0
Secondary DNS IP Address	0 . 0 . 0 . 0

The following table lists available network options.

Display Label	Parameter	Default
IP Address	Device IP Address	192.168.0.203
Subnet Mask	Network Subnet Mask	255.255.255.0
Def. Gateway	Network Default Gateway	192.168.0.1

### NOTE

When you change the device network settings through the Ethernet port, the device port restarts so communication will be temporarily lost. You may need to wait some additional time until PAS restores a connection with your device.

## Setting-Up Dial-Up GPRS Network

Select Communications Setup from the Meter Setup menu, and then click on the Dial-Up Networking Setup tab.

The following table lists available connection options.

Parameter	Options	Default	Description
<b>Connection Options</b>			
IP Address		192.168.10.203	The IP address on the dial-in modem PPP network. Not used in a GPRS network.
Network Subnet Mask		255.255.0.0	The PPP/GPRS network subnet mask
Network Default Gateway		192.168.10.204	The PPP network default gateway. Not used in a GPRS network.
Redial Attempts	0-1000, 0 = forever	0	The number of dial attempts to connect to a remote modem if a connection was unsuccessful.
Connection Timeout	0-9999 sec	120	The modem cancels a call if not connected within the connection timeout time.
Time Between Redial Attempts	0-9999 sec	60	A time delay between redials.
Idle Time Before Hanging Up	0-9999 sec 0 = never	0	The modem disconnects a call if idle for more than the specified idle time.
Rings before Answer	0-99 0 = never	0	The number of rings before the modem answers an incoming call from a remote modem. Not used in a GPRS network.
Modem Initialization		AT&F&D1&C1	Default modem initialisation string. Do not change.

Parameter	Options	Default	Description
<b>ISP Account</b>			
Phone Number		*99#	The telephone number of the ISP provider. The default number provides a connection to the GPRS network for your EM720 GSM/GPRS modem.
Login Name			Login name for logging onto the Internet (if required).
Login Password			Login password for logging onto the Internet (if required).
GPRS Access Point Name (APN)		internet	The mobile network APN name (consult with your network operator)

**NOTE**

Do not change the default modem connection options. Consult with your GPRS network operator if the network subnet mask needs to be extended.

**Setting-Up SNTP Client**

Select Communication Setup from the Meter Setup menu, and then click on the SNTP Client Setup tab.

The SNTP client can provide periodic synchronization of the meter clock with a publicly available SNTP server or with your local server if it supports this service.

To allow clock synchronization via SNTP, select SNTP as a clock synchronization source in [Local Settings](#).

The screenshot shows the 'EM720 - Communication Setup' dialog box. The 'SNTP Client Setup' tab is selected. The settings are as follows:

SNTP Client Setup	
SNTP Client Enabled	YES
Polling interval, s	600
Primary SNTP Server IP Address	192 . 36 . 143 . 151
Secondary SNTP Server IP Address	130 . 149 . 17 . 21

The following table lists available options



Parameter	Options	Default	Description
SNTP Client Enabled	NO, YES	NO	Enables operations of the SNTP client
Polling interval, s	60-86400 s	600 s	The time remaining requesting time from the SNTP server
Primary SNTP Server IP Address		192.36.143.151	The IP address of the primary SNTP server
Secondary SNTP Server IP Address		130.149.17.21	The IP address of a secondary SNTP server in the event of temporary unavailability of the primary server

The default SNTP server IP addresses belong to Stockholm and Berlin university servers.

## Setting-Up eXpertPower Client

Select Communication Setup from the Meter Setup menu, and then click on the ExpertPower Client Setup tab.

The EM720 has an embedded eXpertPower™ client that provides communications with the eXpertPower™ server – the SATEC proprietary Internet services. Connections to the eXpertPower™ server are handled on a periodic basis.

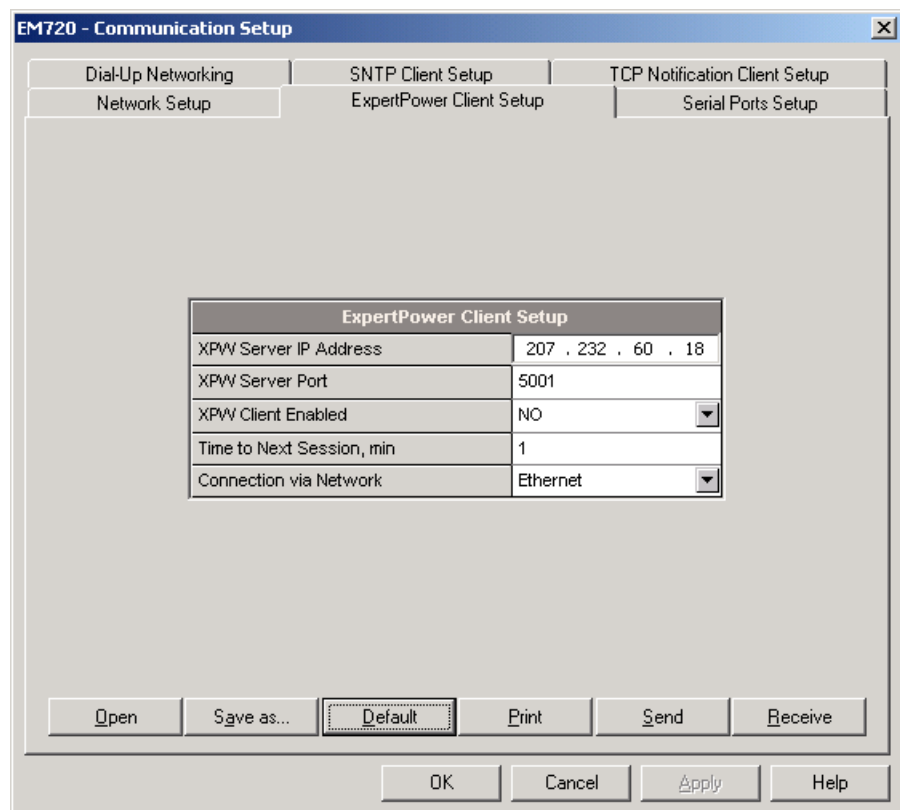

The following table lists available options. Refer to your eXpertPower service provider for the correct eXpertPower settings.

Parameter	Options	Default	Description
XPW Server IP Address		207.232.60.18	The IP address of the eXpertPower server
XPW Server Port	0-65535	5001	The TCP service port of the eXpertPower server
XPW Client Enabled	NO, YES	NO	Enables operations of the eXpertPower client
Time to Next Session, min	1-99999		The time remaining to the next connection session
Connection via Network	Ethernet, GPRS/Modem	Ethernet	Selects the network for connecting to the eXpertPower server

#### NOTES

1. Do not enable the eXpertPower client in your meter if you do not use the eXpertPower™ service.
2. Do not change the connection period setting. The eXpertPower server updates it automatically.

### Setting-Up TCP Notification Client

Select Communication Setup from the Meter Setup menu, and then click on the TCP Notification Client Setup tab.

The TCP notification client can establish connections with a remote Modbus/TCP server and send notification messages either on events, or periodically on a time basis. See the EM720 Modbus Reference Guide for more information on the client operation and the notification message layout.

The screenshot shows the 'EM720 - Communication Setup' dialog box. The 'TCP Notification Client Setup' tab is selected. The settings are as follows:

TCP Notification Client Setup	
Client Enabled	NO
Server IP Address	192 . 168 . 0 . 3
Server Port	502
Message Exchange Address	1000
Connection via Network	Ethernet

Buttons at the bottom: Open, Save as..., Default, Print, Send, Receive, OK, Cancel, Apply, Help.

The server's IP address, port number and starting Modbus register address are programmable in the meter.

The following table lists available options.

Parameter	Options	Default	Description
Client Enabled	NO, YES	NO	Enables operations of the notification client
Server IP Address		192.168.0.3	The IP address of the notification server
Server Port	0-65535	502	The TCP service port of the notification server
Message Exchange Address	0-65535	1000	
Connection via Network	Ethernet, GPRS/Modem		Selects the network for connecting to the notification server

Client connections are triggered via programmable setpoints. To send event notifications to a server, configure a setpoint to respond to desired triggers or to periodic time events and add the "Send notification" action to the end of the setpoint actions list (see [Using Control Setpoints](#)).

Setpoint operation events triggered by regular analog and digital triggers are reported twice - when the event starts and when it ends, except of the pulsed events and time triggers that will be reported once.

In case of triggering notifications with events generated by the PQ and Fault recorders, like the PQ EVENT, FAULT EVENT, EXTERNAL TRIGGER or FAULT DETECTED triggers, the recorded power quality or/and corresponding fault events are reported instead of setpoint-triggered notifications. If regular triggers are added to the setpoint triggers list, then the setpoint operation events will also be reported.

## General Meter Setup

### Basic Meter Setup

The Basic Setup provides the meter with basic information about your electrical network.

#### Using the Front Display



Select Basic from the main menu. See [Viewing and Changing Setup Options](#) in Chapter 3 for information on navigating in menus.

See the table below for available options.

#### Using Pas

Select General Setup from the Meter Setup menu.

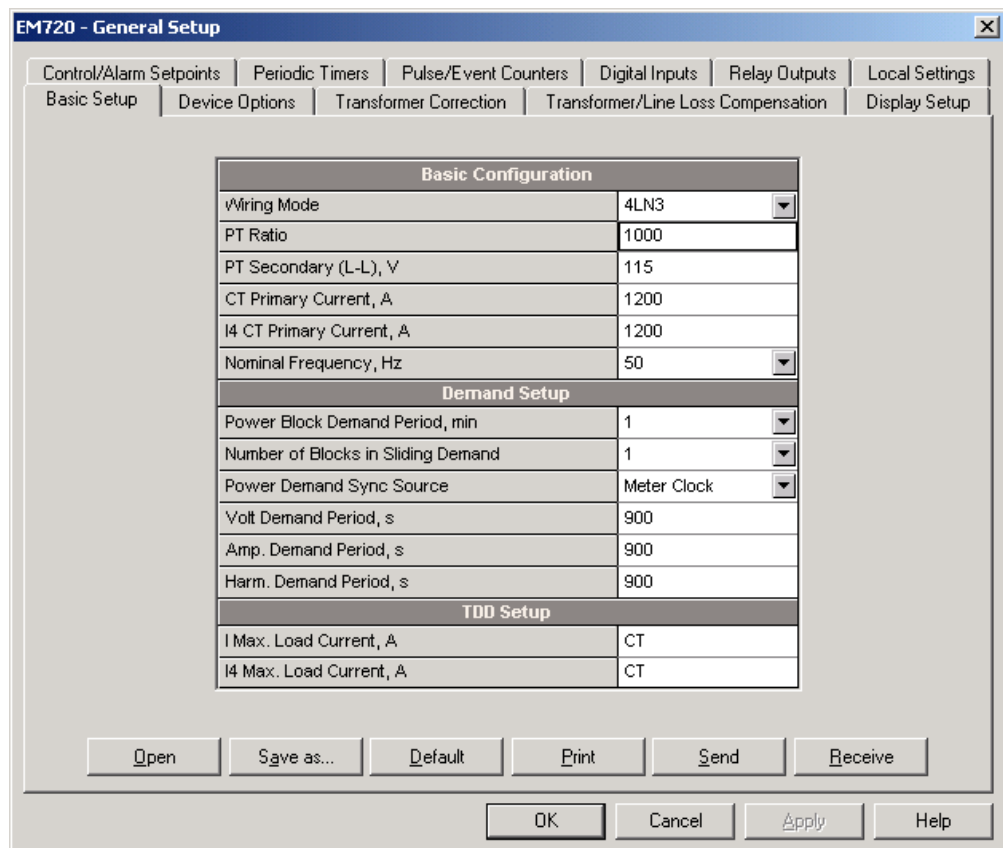

The following table lists available meter configuration options.

Display Label	Parameter	Options	Default	Description
<b>Basic Configuration</b>				
Wiring	Wiring Mode	See Table below	4LN3	The wiring connection of the device
PT Ratio	PT Ratio <sup>1</sup>	1.0-6500.0	1.0	The phase potential transformer's primary to secondary ratio

Display Label	Parameter	Options	Default	Description
Nom. Voltage	PT Secondary (L-L) Voltage	50-480 V	400 V	The nominal secondary line-to-line voltage. Used as a reference voltage for the EN50160 evaluation.
CT Primary	CT Primary Current <sup>1</sup>	1-20,000 A	5 A	The primary rating of the phase current transformer
CT4 Primary	I4 CT Primary Current	1-20,000 A	5 A	The primary rating of the I4 current transformer
Nom. Freq.	Nominal Frequency	50, 60 Hz	50 Hz	The nominal line frequency
<b>Demand Setup</b>				
P.Dmd.Period	Power block demand period	1, 2, 3, 5, 10, 15, 20, 30, 60 min	15 min	The length of the demand period for power demand calculations.
Num. Periods	Number of Blocks in Sliding Demand	1-15	1	The number of blocks to be averaged for sliding window demands
Dmd.Sync.Src	Power Demand Sync Source	Meter clock, DI1-DI8	Meter clock	The source input for synchronization of the demand intervals. If a digital input is specified as the source, a pulse front denotes the start of the demand interval
Volt.Dmd.Per.	Volt Demand Period	0-9000 sec	900 sec	The length of the demand period for volt demand calculations
Amp.Dmd.Per.	Ampere Demand Period	0-9000 sec	900 sec	The length of the demand period for ampere demand calculations
Hrm.Dmd.Per.	THD Demand Period	0-9000 sec	900 sec	The length of the demand period for THD demand calculations
<b>TDD Setup</b>				
Max.Dmd.Load	I Max. Load Current	0 – 20,000 A 0 = CT primary	0	The maximum demand load current for phase current inputs
I4 M.Dmd.Load	I4 Max. Load Current	0 – 20,000 A 0 = CT primary	0	The maximum demand load current for I4 current input

<sup>1</sup> The maximum value for the product of the CT primary current and PT ratio is 57,500,000. If the product is greater, power readings are zeroed.

Available wiring modes are listed in the following table.

Wiring Mode	Description
3OP2	3-wire Open Delta using 2 CTs (2 element)
4LN3	4-wire Wye using 3 PTs (3 element), line-to-neutral voltage readings
3DIR2	3-wire Direct Connection using 2 CTs (2 element)
4LL3	4-wire Wye using 3 PTs (3 element), line-to-line voltage readings
3OP3	3-wire Open Delta using 3 CTs (2½ element)
3LN3	4-wire Wye using 2 PTs (2½ element), line-to-neutral voltage readings
3LL3	4-wire Wye using 2 PTs (2½ element), line-to-line voltage readings

#### NOTE

In 4LN3 and 3LN3 wiring modes, the voltage readings for volt demands represent line-to-neutral voltages; otherwise, they will be line-to-line voltages. The voltage waveforms and harmonics in 4LN3 and 3LN3 wiring modes represent line-to-neutral voltages; otherwise, they will be line-to-line voltages.

## Device Options and Mode Control

### Using the Front Display

```
Options  Power Mode
          Reactive
```

```
Test     Test Mode
          OFF
```

To enter the common options setup menu, select Options from the main menu.

To enter the TEST mode options setup, select Test from the main menu. You can also use an extended press on the SCROLL + SELECT/ENTER buttons from the clock display as a shortcut for immediate entering the TEST mode setup.

See [Viewing and Changing Setup Options](#) in Chapter 3 for information on navigating in menus.

See the table below for available options.

### Using PAS

Select General Setup from the Meter Setup menu, and then click on the Device Options tab.

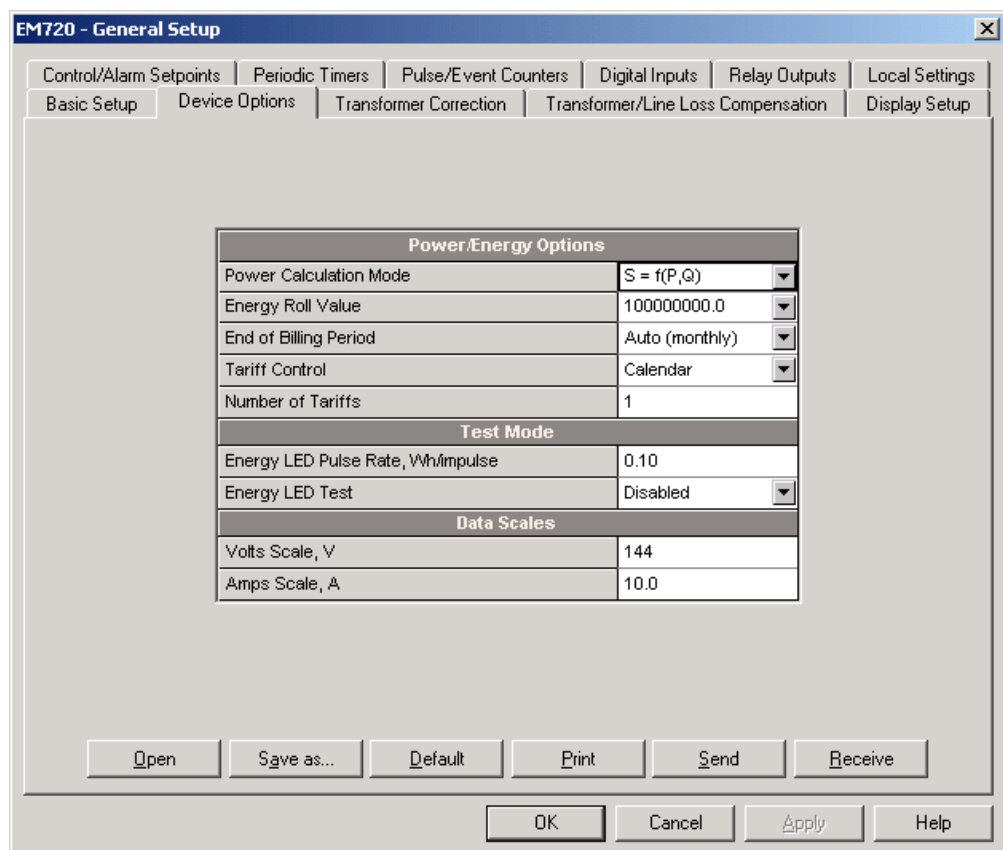

### NOTE

Test Mode options and other device options have different security levels. You may not be allowed to change the device options if the user password you provided does not have required permissions.

The following table lists available device options.

Display Label	Parameter	Options	Default	Description
<b>Power/Energy Options</b>				
Power Mode	Power Calculation Mode	S=f(P, Q) (reactive power mode), Q=f(S, P) (non-active power mode)	S=f(P, Q)	The method used for calculating reactive and apparent powers (see "Power Calculation Modes" below)
Energy Roll	Energy Roll Value, kWh	1000.0 10000.0 100000.0 1000000.0 10000000.0 100000000.0	100000000.0	The value at which energy counters roll over to zero
End of Bill	End of Billing Period	Auto (monthly) Auto/COM Auto/COM/Manual COM Manual	Auto (monthly)	Triggering an end of billing period: Auto – monthly self-reading COM – remote via communications Manual – from the front display
Trf Control	Tariff Control	Calendar Communication Tariff inputs D1...D8	1	Defines the tariff switching method (see "Tariff Control" below).
Num Tariffs	Number of tariffs	1-8	1	Defines the number of season tariff rates when no TOU calendar schedule is available
Trans. Corr.		OFF (disabled) ON (enabled)	OFF	Enables instrument transformer correction – only via the front display
Loss Comp.		OFF (disabled) ON (enabled)	OFF	Enables transformer/line loss compensation – only via the front display
<b>Test Mode</b>				
Test Mode	Energy LED Test	OFF (disabled) ON (enabled)	Disabled	Setting this option puts the meter into TEST mode
Pulse Const	Energy LED pulse rate, Wh/impulse	0.01-0.25 Wh/imp (100,000 – 4,000 imp/kWh)	0.10 Wh/imp (10,000 imp/kWh)	Test LED pulse constant - the amount of accumulated energy (in secondary units) giving one pulse via "kWh" and "kvarh" LEDs.
<b>Data Scales</b>				
N/A	Volts Scale, V	60-600 V	144 V	The maximum voltage scale allowed, in secondary volts. See <a href="#">Data Scales</a> in Appendix F
N/A	Amps Scale, A	1.0 – 50.0	2A/10 A	The maximum current scale allowed, in secondary amps. See <a href="#">Data Scales</a> in Appendix F

### Power Calculation Modes

The power calculation mode option allows you to change the method for calculating reactive and apparent powers in presence of high harmonics. The options work as follows:

1. When the reactive power calculation mode is selected, active and reactive powers are directly measured and apparent power is calculated as:

$$S = \sqrt{P^2 + Q^2}$$

2. This mode is recommended for electrical networks with low harmonic distortion, commonly with THD < 5% for

volts, and THD < 10% for currents. In networks with high harmonics, the following method is preferable.

- When the non-active power calculation mode is selected, active power is measured directly, apparent power is taken as product  $S = V \times I$ , where V and I are the RMS volts and amps, and reactive power (called non-active power) is calculated as:

$$N = \sqrt{S^2 - P^2}$$

### Tariff Control

The EM720 provides three options for switching tariff rates:

- automatic via a programmable TOU calendar schedule (see [Configuring the Daily Tariff Schedule](#) for information on configuring tariff change points)
- external via communications by writing a tariff number to the meter tariff register (see the EM720 Modbus Reference Guide for information on the active tariff register location)
- external via digital inputs by providing a tariff code on the meter tariff inputs

If a digital input option is selected, you can use 1 to 3 consequent digital inputs as tariff inputs. The following table shows the number of inputs required depending on the maximum number of used tariff rates.

Number of tariffs	Number of tariff inputs
2	1
3	2
4	2
5	3
6	3
7	3
8	3

The following table shows code combinations that should be provided on the tariff inputs to indicate an active tariff rate.

Tariff rate number	Tariff code		
	Tariff input 1	Tariff input 2	Tariff input 3
1	Open	Open	Open
2	Closed	Open	Open
3	Open	Closed	Open
4	Closed	Closed	Open
5	Open	Open	Closed
6	Closed	Open	Closed
7	Open	Closed	Closed
8	Closed	Closed	Closed



## Instrument Transformer Correction Setup

Transformer correction allows you to compensate ratio and phase angle inaccuracies of the voltage and current instrument transformers.

Select General Setup from the Meter Setup menu, and then click on the Transformer Correction tab.

No.	Channel	Test Point, %	Ratio Correction Factor	Phase Angle Error, (+/-) minutes
1	V1	80	1.005	-5
2	V1	100	1.003	-15
3	V1	120	1.008	-30
4	V2	80	1.005	-5
5	V2	100	1.003	-15
6	V2	120	1.008	-30
7	V3	80	1.004	-5
8	V3	100	1.002	-15
9	V3	120	1.008	-30
10	I1	5	0.985	90
11	I1	20	0.993	45
12	I1	100	0.995	30
13	I1	120	0.995	25
14	I2	5	0.985	90
15	I2	20	0.993	45

Correction Enabled

Open Save as... Default Print Send Receive

OK Cancel Apply Help

The available options are listed in the following table.

Parameter	Options	Description
Channel	None, V1-V3, I1-I4	Voltage/current channel
Test Point, %	5-200%	Percent of the nominal (rated) voltage/current at which the ratio correction factor and phase angle error are specified
Ratio Correction Factor	0.900-1.100	The ratio of the true transformer ratio to the marked ratio
Phase Angle Error	+/-600 minutes	The phase displacement, in minutes, between the primary and secondary values. The phase angle of a transformer is positive when the secondary value leads the primary value.

You can define a total of 56 correction points for ratio and phase correction data - up to 8 test points per voltage and current channel, based on the transformer's accuracy characteristics. If more than one test point is given for a channel, the meter dynamically interpolates to the actual operating point depending on the measured voltage or current. When a single test point is defined, it is applied over the full operating range of the transformer.

The order in which you define the test points does not matter. The meter will automatically arrange all data in a correct order.

Check the Correction Enabled box to activate transformer correction in the meter. You can also enable and disable transformer correction from the front display (see [Device Options and Mode Control](#)).

## Transformer/Line Loss Compensation Setup

Loss compensation corrects the power and energy readings of the meter when the metering point and point of billing are physically separated by a power transformer or a power line.

Select General Setup from the Meter Setup menu, and then click on the Transformer/Line Loss Compensation tab.

Metering and Location		Supply-side Power Line Data	
Compensation Enabled	Enabled	Length, miles	127.000
Metering Point Location	Load side, trans. end	Resistance, Ohm/mile	0.020
Billing Point Location	Supply side, far end	Reactance, Ohm/mile	0.400
Number of Metering Elements	3 (WYE)	Load-side Power Line Data	
Power Transformer Data		Length, miles	0.000
Primary Rated Voltage, V	115000	Resistance, Ohm/mile	0.000
Secondary Rated Voltage, V	2520	Reactance, Ohm/mile	0.000
Rated Power, kVA	9999	%Loss Constants	
No-load Iron Watts Loss	28680	Iron Watt Losses, %LWFe	0.1656
Full-load Copper Watts Loss	56027	Copper Watt Losses, %LWCu	0.4343
Percent Excitation Current	1.020	Iron VAR Losses, %LVFe	0.5651
Percent Impedance	8.100	Copper VAR Losses, %LVCu	6.8828

Buttons: Open, Save as..., Default, Print, Send, Receive, Calculate %Loss Constants, OK, Cancel, Apply, Help

The available options are described in the following table.

Parameter	Options	Description
Metering and Location		
Loss Compensation Enabled	Disabled, Enabled	Enables/disables loss compensation
Metering Point Location	Supply side, far end, Supply side, transformer end, Load side, transformer end, Load side, far end	Defines the location of the meter: far end – near the supply source or near the load, transformer end – near the power transformer.

Parameter	Options	Description
Billing Point Location	Supply side, far end, Supply side, transformer end, Load side, transformer end, Load side, far end	Defines the location of the billing point: far end – near the supply source or near the load, transformer end – near the power transformer.
Number of Metering Elements	2 (Open Delta) 3 (WYE)	Defines the number of metering elements in the meter depending on the wiring mode. Select 2 for 3OP2/3OP2, and 3 for 4LN3/4LL3 wiring modes.
<b>Power Transformer Data</b>		
Primary Rated Voltage, V		Primary rated voltage of the power transformer
Secondary Rated Voltage, V		Secondary rated voltage of the power transformer
Rated Power, kVA		Rated transformer power
No-load Iron Watt Loss		Watt losses at rated voltage due to iron
Full-load Copper Watt Loss		Watt losses at rated voltage due to copper
Percent Excitation Current		Transformer percent exciting current
Percent Impedance		Transformer percent impedance
<b>Supply-side Power Line Data</b>		
Length, miles		Power line length, in miles or km
Resistance, Ohm/mile		Power line resistance, in Ohm/mile or Ohm/km
Reactance, Ohm/mile		Power line inductance, in Ohm/mile or Ohm/km
<b>Load-side Power Line Data</b>		
Length, miles		Power line length, in miles or km
Resistance, Ohm/mile		Power line resistance, in Ohm/mile or Ohm/km
Reactance, Ohm/mile		Power line inductance, in Ohm/mile or Ohm/km
<b>%Loss Constants</b>		
Iron Watt Losses, %LWFe		Percent watt losses due to iron
Copper Watt Losses, %LWCu		Percent watt losses due to copper
Iron VAR Losses, %LVFe		Percent var losses due to iron
Copper VAR Losses, %LVCu		Percent var losses due to copper

The EM720 uses pre-calculated loss constants for correcting meter readings. All calculations are performed by Pas using transformer and power line data, and then the resulting loss constants are downloaded to the meter. If power line losses are included in compensation, they are added to the loss constants.

For more information on the loss calculation techniques, see the Handbook for Electricity Metering, 10-th edition, by the Edison Electric Institute.

**To configure loss constants in the meter:**

1. Specify the locations of the meter and a point of billing. The losses will be added to, or subtracted from the measured power depending on the locations of the metering and billing points. Use the picture and table below to check your settings.

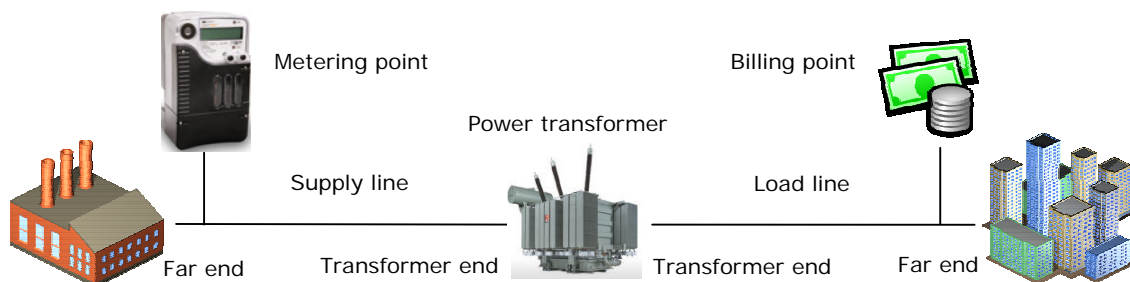

Billing Point \ Metering Point	Supply side, far end	Supply side, transformer end	Load side, transformer end	Load side, far end
Supply side, far end		-Supply line losses	-Supply line losses -Transformer losses	-Supply line losses -Transformer losses -Load line losses
Supply side, transformer end	+Supply line losses		-Transformer losses	-Transformer losses -Load line losses
Load side, transformer end	+Supply line losses +Transformer losses	+Transformer losses		-Load line losses
Load side, far end	+Supply line losses +Transformer losses +Load line losses	+Transformer losses +Load line losses	+Load line losses	

4. Select the number of metering elements depending on the wiring mode set in the meter. It is not a critical parameter and the actual losses will not be affected by this setting.
5. Specify the power transformer data. It is normally taken from the transformer nameplate and transformer datasheet. All transformer data is given for a 3-phase system.
6. If the supply-side or/and load-side power line losses are to be included in compensation, specify the length of power lines and their resistance and reactance per mile or km. To change the length units, select Options from the Tools menu, click on the Preferences tab, and then check the preferred distance units.
7. After all data is specified, click on the Calculate %Loss Constants button to update the loss constants.
8. Select Enable in the Loss Compensation Enabled box to enable loss compensation in the meter.
9. Send your new setup to the meter.

#### NOTE

You can also enable and disable loss compensation via the front display (see [Device Options and Mode Control](#)).

## Local Settings

This setup allows you to specify your local time zone, daylight saving time options and time synchronization source.

### Using the Front Display



Select Local from the main menu. See [Viewing and Changing Setup Options](#) in Chapter 3 for information on navigating in menus.

See the table below for available options.

### Using PAS

Select General Setup from the Meter Setup menu, and then click on the Local Settings tab.

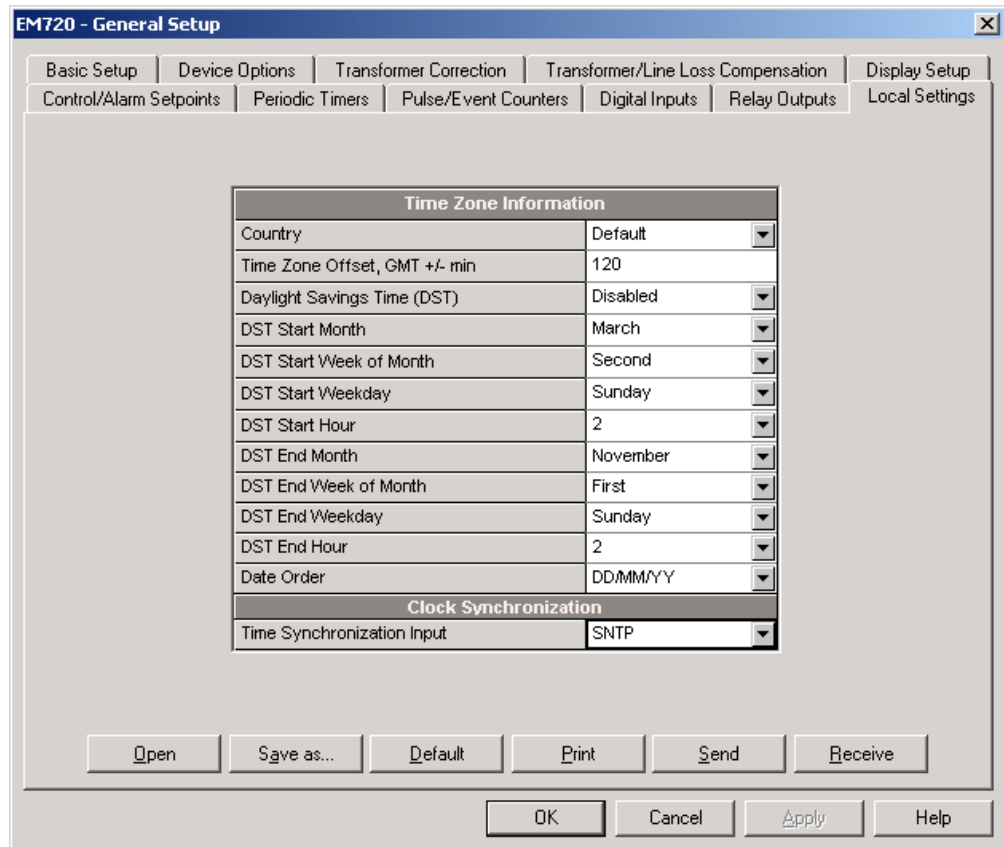

The available options are listed in the following table.

Display Label	Parameter	Options	Default	Description
Country	Country	Default, or country name	Default	Indicates the location of the meter. The default setting stands for the U.S.A.
Offset	Time zone offset, min	-720 to 720 min	120	Local offset in minutes from UTC (Universal Coordinated or Greenwich Mean Time). Required if the GPS IRIG-B or SNTP synchronization is selected.
Daylight	Daylight saving time (DST)	Disabled Enabled Scheduled	Disabled	Disabled: the RTC operates in standard time only. Enabled: the time is automatically updated at the predefined fixed DST switch dates. Scheduled: the time is automatically updated at the calendar scheduled DST switch dates.
Start Month	DST Start Month	January-December	March	The month when DST begins.
Start Week	DST Start Week	First, Second, Third, Fourth, Last	Second	The week when DST begins.
Start Day	DST Start Day	Sunday-Saturday	Sunday	The day when DST begins.
Start Hour	DST Start Hour	1-6	2	The hour when DST begins.
End Month	DST End Month	January-December	November	The month when DST ends.
End Week	DST End Week	First, Second, Third, Fourth, Last	First	The week when DST ends.

Display Label	Parameter	Options	Default	Description
End Day	DST End Day	Sunday-Saturday	Sunday	The day when DST ends.
End Hour	DST End Hour	1-6	2	The hour when DST ends.
Date Order	Date Order	MM/DD/YY DD/MM/YY YY/MM/DD	DD/MM/YY	The display date order
Clock Sync	Time synchronization input	None IRIG-B SNTP DI1...DI8 1PPM DI1...DI4 1PPS	None	The external port receiving the time synchronization signal

## Daylight Saving Time

By default, the daylight saving time option is disabled in the EM720.

When the DST option is enabled, the meter automatically adjusts the clock at the predefined start/end time when daylight savings time begins/ends.

When the DST option is set to Scheduled mode, the only DST start/end hours are used, while the DST switch dates are taken from the TOU calendar (see [Configuring the Season Tariff and DST Schedule](#)). If the DST switch dates are not found in the calendar for the present year, the meter uses the dates you defined in your Local Settings.

When the daylight savings option is disabled, the device clock should be manually adjusted for daylight saving time.

## Time Synchronization Sources

The EM720 can synchronize its clock with a remote SNTP server via the Internet, or receive the time synchronization signal either from a GPS clock with an IRIG-B time-code output, or from an external device providing second-aligned (1PPS) or minute-aligned (1PPM) pulses.

### Using the IRIG-B

Select the GPS IRIG-B option and connect the GPS master clock to the meter IRIG-B input. See [Meter Clock and Time Synchronization](#) for the IRIG-B input location.

The EM720 automatically synchronizes its clock with the GPS time each second, normally with accuracy better than one millisecond if the time is locked to the GPS satellite time. When the GPS clock loses the satellite, the clock continues to generate the IRIG-B time code referenced to the last available satellite time (called unlocked time), but the time quality may get worse. Such losses may continue from a few minutes to hours. The time code generated during outages is typically accurate to within a few milliseconds over a 24-hour period.

If the signal from the GPS master clock is not detected on the meter input, the EM720 changes the time synchronization source to the internal RTC in 10 minutes after signal is lost.

When the signal is restored, the meter automatically acquires the GPS time.

Whenever the IRIG-B signal status or quality changes, the corresponding event is automatically recorded to the device Event log.

You can check presence and quality of the IRIG-B signal via the device diagnostics display (see [Device Diagnostics Display](#) in Chapter 3) or via PAS (see [Clearing Device Diagnostics](#) in Chapter 6).

### Using SNTP

Enable SNTP client operation and configure it if required (see [Setting-Up SNTP Client](#)).

When an SNTP server is not available or when a connection with a server is restored, the corresponding event is automatically recorded to the device Event log.

### Using Time Synchronization Pulses

Select one of the available digital inputs as either 1PPS, or 1PPM synchronization input.

The transition edge of an external pulse (open-to-close or close-to-open transition depending on the selected pulse polarity) adjusts the meter clock to the nearest whole second for a 1PPS source, or to the nearest whole minute for a 1PPM source. The time accuracy may be affected by the operation delay of an external relay.

## Display Setup



### Using the Front Display

Select Display from the main menu. See [Viewing and Changing Setup Options](#) in Chapter 3 for information on navigating in menus.

See the table below for available display options.

### Using PAS

Select General Setup from the Meter Setup menu, and then click on the Display Setup tab.

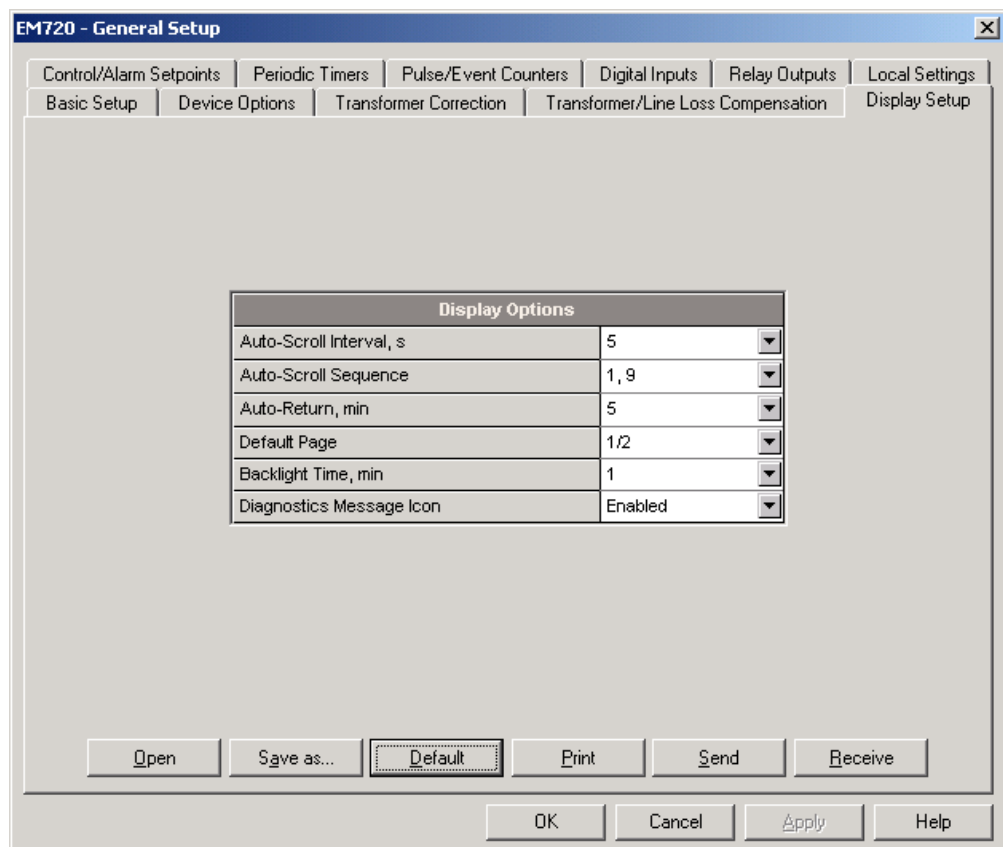

The available options are listed in the table below.

See [Display Operations](#) in Chapter 3 for more information on display functionality and configuring display options. See [Data Displays](#) for information on display page contents and enumeration.



Display Label	Parameter	Options	Default	Description
Auto-Scroll	Auto-Scroll Interval	Disabled, 2-10, 15, 20, 25, 30 seconds	5	Defines the display scroll interval or disables auto-scroll
Scroll Seq.	Auto-Scroll Sequence	1-2, 1-3, 1-4, 1-5, 1-6, 1-7, 1-8, 1-9 1, 5-9 1-2, 5-9 1-3, 5-9 1, 6-9 1-2, 6-9 1-3, 6-9 1-4, 6-9 1, 7-9 1-2, 7-9 1-3, 7-9 1-4, 7-9 1, 8-9 1-2,8-9 1-3,8-9 1-4,8-9 1, 9 1-2, 9 1-3, 9 1-4, 9	1, 9	Selects the display sequence for auto-scrolling from 9 data displays (see <a href="#">Data Displays</a> for display enumeration)
Auto-Return	Auto-Return	Disabled, 1-5, 10, 15, 20, 25, 30 min	5	Defines the time delay before returning to the default page
Def. Page	Default Page	1/2 – 1/10 2/1 – 2/10 ... 9/1-9/10	1/2	Specifies the default display/page. If a page is not available in present mode, the following available page will be displayed.
Backlight	Backlight Time	Continuous, 1-10 min	1	Defines the time while the backlight is ON
Diag. Icon	Diagnostic Message Icon	Disabled Enabled	Enabled	Disables/Enables the blinking diagnostic icon in the data displays

## Configuring Digital Inputs

The EM720 has four embedded digital inputs (DI1 to DI4) and supports up to two expansion 2DI/2DO modules with a total of 4 digital inputs (DI5 to DI8). I/O numbers are automatically assigned to the inputs in the order of connection. If you insert an I/O module into another slot position and do not change its order, then all digital inputs on the module retain their I/O numbers.

To configure the digital inputs in your meter, select General Setup from the Meter Setup menu, and then click on the Digital Inputs tab. Digital inputs that are not present in your meter are not shown.

No.	Pulse Input Mode	Pulse Polarity	Debounce Time, ms	Fault Recorder
1	PULSE MODE	NORMAL (N.O.)	10	<input type="checkbox"/>
2	PULSE MODE	NORMAL (N.O.)	10	<input type="checkbox"/>
3	PULSE MODE	NORMAL (N.O.)	10	<input type="checkbox"/>
4	PULSE MODE	NORMAL (N.O.)	10	<input type="checkbox"/>
5	PULSE MODE	NORMAL (N.O.)	----	<input type="checkbox"/>
	KYZ MODE	INVERTING (N.C.)	----	<input type="checkbox"/>
7	----	----	----	<input type="checkbox"/>
8	----	----	----	<input type="checkbox"/>
9	----	----	----	<input type="checkbox"/>
10	----	----	----	<input type="checkbox"/>
11	----	----	----	<input type="checkbox"/>
12	----	----	----	<input type="checkbox"/>
13	----	----	----	<input type="checkbox"/>
14	----	----	----	<input type="checkbox"/>
15	----	----	----	<input type="checkbox"/>
16	----	----	----	<input type="checkbox"/>

The available options are shown in the following table.

Parameter	Options	Default	Description
Pulse input mode	PULSE MODE KYZ MODE	PULSE MODE	Pulse mode: either leading, or trailing edge of the input pulse is recognized as an event. KYZ mode: both leading and trailing edges of the input pulse are recognized as separate events.
Pulse polarity	NORMAL (N.O.) INVERTING (N.C.)	NORMAL	Normal polarity: the open to closed transition is considered a pulse. Inverting polarity: the closed to open transition is considered a pulse. It has no meaning in KYZ mode where both transitions are effective.

Parameter	Options	Default	Description
Debounce time	1-1000 ms	10 ms	The amount of time while the state of the digital input should not change to be recognized as a new state. Too low debounce time could produce multiple events on the input change.
Fault Recorder	Checked Unchecked	Unchecked	When the box is checked, a positive transition on the digital input (open to closed transition event) triggers the Fault recorder.

### Debounce Time

The debounce time is assigned in groups of 2 adjacent digital inputs. DI1 and DI2 have the same debounce time, while DI3 and DI4 are allowed to have another setting. If you change the debounce time for a digital input, the same debounce time is automatically assigned to the second input in the same group.

### Triggering the Fault Recorder through Digital Inputs

Check the Fault recorder boxes for digital inputs you wish to use as triggers for the Fault recorder.

When an open-to-closed state transition is detected on the digital input, the global "External Trigger" event is generated in the meter. If the external triggers are enabled in the Fault recorder (see [Configuring the Fault Recorder](#)), it triggers the recorder to record waveforms or RMS data profile for the event.

When a number of digital inputs linked to the Fault recorder are operated at the same time, only the first triggers the Fault recorder and logs a fault event into the Fault log file. The next external fault event is not triggered until all digital inputs linked to the Fault recorder are released. This does not affect operations of the internal analog fault triggers that work independently.

Notice that the "External Trigger" event can also be tested through the control setpoints from the "Static Events" trigger group to trigger another action on your selection.

## Configuring Relay Outputs

The EM720 supports up to two expansion 2DI/2DO modules with a total of 4 relays (RO1 through RO4). I/O numbers are automatically assigned to outputs in the order of connection.

To configure the relay outputs in your meter, select General Setup from the Meter Setup menu, and then click on the Relay Outputs tab. Relays that are not present in your meter are not shown.

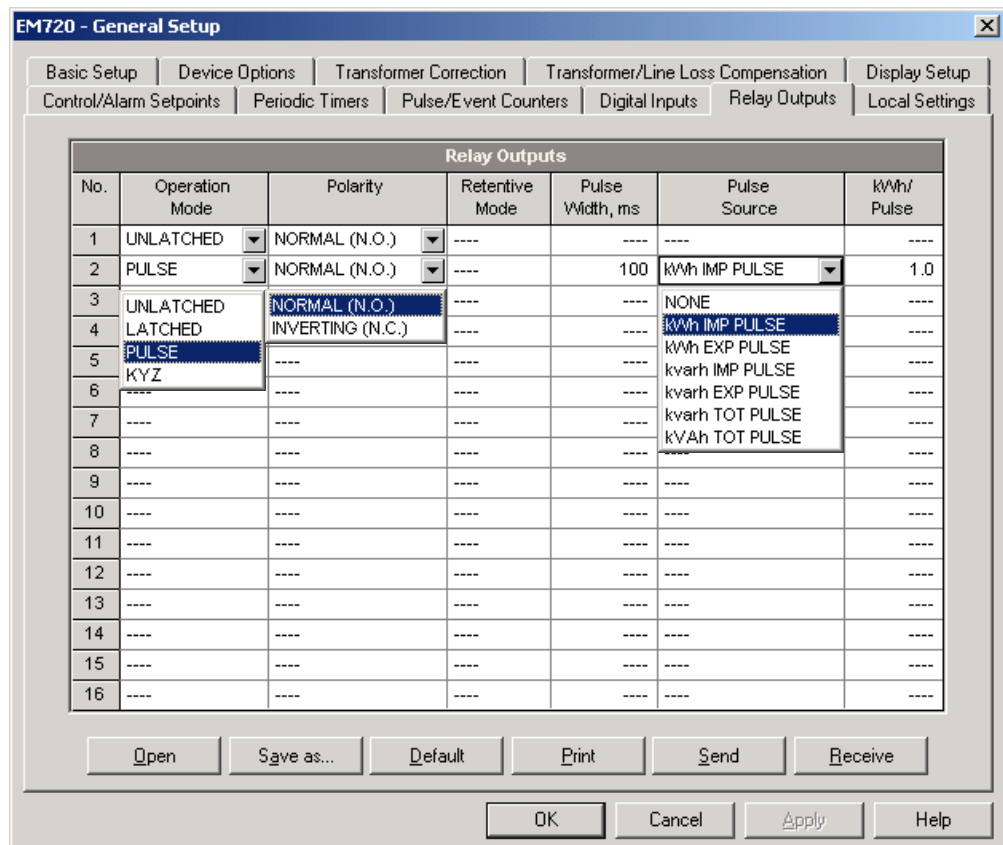

The available relay options are described in the table below.

Parameter	Options	Default	Description
Operation mode	UNLATHCED LATCHED PULSE KYZ	UNLATCHED	<p>Unlatched mode: the relay goes to its active state when the control setpoint is in active (operated) state, and returns to its non-active state when the setpoint is released.</p> <p>Latched mode: the relay goes to its active state when the control setpoint goes to active state and remains in the active state until it is returned to its non-active state by a local or remote command.</p> <p>Pulse mode (normal pulses): the relay goes to its active state for the specified time, goes to non-active state for the specified time and remains in the non-active state.</p> <p>KYZ mode (transition pulses): the relay output state is changed upon each command and remains in this state until the next command.</p>

Parameter	Options	Default	Description
Polarity	NORMAL (N.O.) INVERTING (N.C.)	NORMAL	Normal polarity: the relay is normally de-energized in its non-active state and is energized in its active (operated) state. Inverting polarity: the relay is normally energized in its non-active state and is de-energized in its active (operated) state. It is called failsafe relay operation.
Retentive mode	NO YES	NO	Applicable for latched relays only. Non-retentive mode: the relay always returns to its non-active state upon power up. Retentive mode: the relay status is restored to what it was prior to loss of power.
Pulse width	20-1000 ms	100 ms	The actual pulse width is a multiple of the 1/2-cycle time rounded to the nearest bigger value. The pause time between pulses is equal to the pulse width.
Pulse source	NONE kWh IMP kWh EXP kvarh IMP kvarh EXP kvarh TOT kVAh	NONE	Links a pulse relay to the internal energy pulse source. The relay must be set into either pulse, or KYZ mode.
Pulse rate, kWh/Pulse	0.1-1000.0	1.0 kWh/Pulse	Defines the pulse weight in kWh units per pulse.

### Output of Energy Pulses through Relay Outputs

#### To generate energy pulses through a relay output:

1. Set a relay to either pulse, or KYZ mode, and then select a polarity (active pulse edge) for energy pulses and a pulse width.
2. Select a source accumulator (type of energy) and the pulse rate for your output.
3. Send your new setup to the meter.

## Using Counters

The EM720 provides 8 universal nine-digit counters that can count different events.

Each counter can be independently linked to any digital input and count input pulses with a programmable scale factor. You can link a number of digital inputs to the same counter. Each counter can also be incremented through the Control Setpoints in response to any internal or external event.

To configure the meter counters, select General Setup from the Meter Setup menu, and then click on the Pulse/Event Counters tab.

Pulse/Event Counters			
Counter	Pulse Input	Multiplier	Counter Value
1	DIGITAL INPUT #1	1	0
2	DIGITAL INPUT #5	10	0
3	----	1	0
4	----	1	0
5	----	1	0
6	----	1	0
7	----	1	0
8	----	1	0
9	----	----	----
10	----	----	----
11	----	----	----
12	----	----	----
13	----	----	----
14	----	----	----
15	----	----	----
16	----	----	----

The available options are described in the following table:

Option	Range	Default	Description
Pulse Input	None, DI1-DI8	None	Links a digital input to the counter
Multiplier	1-9999	1	The value added to the counter when a pulse is detected on the pulse source input
Counter Value	0-999999999		Displays the present counter contents

## Using Periodic Timers

The EM720 has 4 programmable interval timers that are normally used for periodic recording and triggering operations on a time basis through the Control Setpoints.

Whenever a programmed timer interval is expired, the timer generates an internal event that can trigger any setpoint (see [Using Control Setpoints](#)). The programmable time interval can be from 1 cycle and up to 24 hours. Though it is defined in 0.001-second units, the actual value will be rounded in the meter to a nearest bigger 1/2 cycle multiple.

To configure interval timers, select General Setup from the Meter Setup menu, and then click on the Periodic Timers tab.

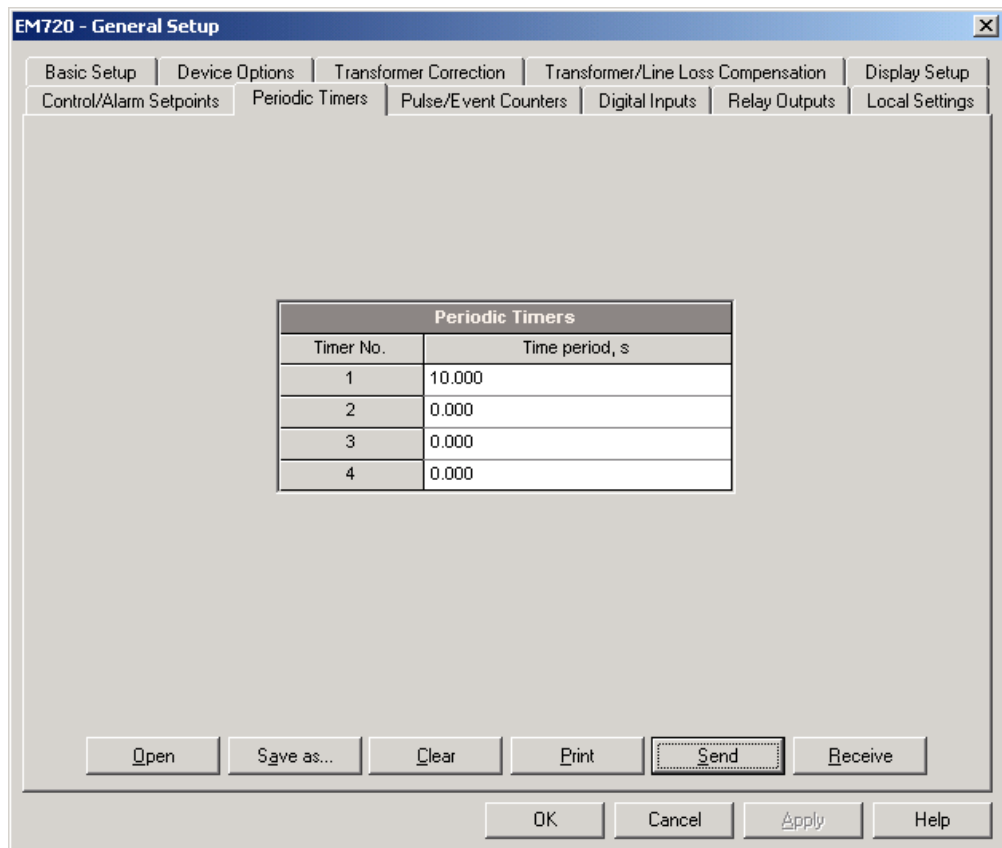

To run a periodic timer, specify a non-zero time period.

To stop a timer, set the time period to zero.

## Using Control Setpoints

The EM720 has an embedded logical controller that runs different actions in response to user-defined internal and external events. Unlike a PLC, the EM720 uses a simplified programming technique based on setpoints that allows the user to define a logical expression based on measured analog and digital values that produces a required action.

The EM720 provides 16 control setpoints with programmable operate and release delays. Each setpoint evaluates a logical expression with up to four arguments using OR/AND logic. Whenever an expression is evaluated as “true”, the setpoint performs up to four concurrent actions that can send a command to the output relays, increment or decrement a counter, or trigger a recorder.

To program the setpoints, select General Setup from the Meter Setup menu, and then click on the Control/Alarm Setpoints tab.

The available setpoint options are described in the following table:

Option	Format/Range	Description
<b>Setpoint Triggers</b>		
OR/AND	OR, AND	The logical operator for the trigger
Input group		The trigger parameter group (see Appendix A)
Trigger parameter		The trigger parameter that is used as an argument in the logical expression (see Appendix A)
Relation	<=, >=, =, ON, OFF	The relational operator used in the conditional expression for the trigger



Option	Format/Range	Description
Operate limit		The threshold (in primary units) at which the conditional expression would be evaluated to true. Not applicable for digital triggers.
Release limit		The threshold (in primary units) at which the conditional expression would be evaluated to false. Defines the hysteresis for analog triggers. Not applicable for digital triggers.
<b>Setpoint Actions</b>		
Action		The action performed when the setpoint expression is evaluated to true (see Appendix B)
Target		The optional action target
Parameter		The optional action argument (reserved)
<b>Delays</b>		
Operate delay	0-10,000.000 s	The time delay before operation when the operate conditions are fulfilled
Release delay	0-10,000.000 s	The time delay before release when the release conditions are fulfilled

The logical controller provides very fast response to events. The scan time for all setpoints is 1/2 cycle time (8 ms at 60Hz and 10 ms at 50 Hz).

### Factory Preset Setpoints

Setpoint #1 is factory preset to provide standard instrumentation data trending. It is linked to the meter clock and triggers Data logs #1 and #2 on a 15-minute time basis.

Setpoint #16 is factory preset to provide energy load profile recording to Data log #12 at 15-minute intervals. It is protected from changes except of the time trigger operate limit that you can set to any value from 1 to 60 minutes on your selection.

### Using Logical Expressions

Logical operators OR/AND are treated in a simplified manner. They have no specific priority or precedence rules.

Any trigger condition bound to the logical expression by the OR operator and evaluated as "true" overrides any preceding condition evaluated as "false". Similarly, any trigger condition evaluated as "false" and bound by the AND operator overrides any condition evaluated before it as "true".

To avoid confusion, it is recommended not to alternate different logical operators in one expression. Instead, bring all conditions that use the same logical operator together at one side of the expression, and the others - at the opposite side.

To explicitly override all other conditions with the critical trigger, put it at the end of the expression using the OR operator if you want the setpoint to be operated anyway when the trigger condition is asserted, and with the AND operator, if the setpoint should not be operated while the critical trigger is not asserted.

## Using Numeric Triggers

For numeric (analog) triggers, a setpoint allows you to specify two thresholds for each trigger to provide hysteresis (dead band) for setpoint operations. The Operate Limit defines the operating threshold, and the second Release Limit defines the release threshold for the trigger. The trigger thresholds are always specified in primary units.

If you use relational operators as " $\leq$ " (under or equal) or " $\geq$ " (over or equal), always specify a correct Release Limit for the trigger. If you do not want to use hysteresis, set the Release Limit to the same as the Operate Limit.

## Using Binary Triggers

Binary (digital) triggers, as digital inputs, relays, or internal static and pulsed events, are tested for ON (closed/set) or OFF (open/cleared) status.

The binary events are divided into two types: static events and pulsed events. Static events are level-sensitive events. A static event is asserted all the time while the corresponding condition exists. Examples are digital inputs, relays and internal static events generated by device diagnostics, and by the Power Quality and Fault recorders.

Pulsed events are edge-sensitive events with auto-reset. A pulsed event is generated for a trigger only once when a positive transition edge is detected on the trigger input. The examples of pulsed events are pulse inputs (transition pulses on the digital inputs), internal pulsed events (energy pulses and time interval pulses), and events generated by the interval timers. The logical controller automatically clears pulsed events at the end of each scan, so that triggers that used pulsed events are prevented from being triggered by the same event once again.

## Using Event Flags

The EM720 has 8 common binary flags, called event flags, which can be individually set, cleared and tested through setpoints or remotely.

Event flags can be used in different applications, for example, to transfer events between setpoints in order to expand a logical expression or a list of actions that have to be done for a specific event, or to remotely trigger setpoint actions from the SCADA system or from a PLC. See [Device Event Flags](#) on how to check and change event flags via PAS.

## Using Interval Timers

The EM720 has 4 interval timers that are commonly used for periodic recording of interval data at the time of the fault or in the presence of other events detected by setpoints. They can be programmed to generate periodic events at user-defined intervals (see [Using Periodic Timers](#)).

Interval timers are not synchronized with the clock. When you run a timer, it generates a pulsed timer event that can trigger a setpoint if you have put the timer into a list of the

setpoint triggers. When the setpoint event is asserted, the timer is restarted, and then generates the next timer event when the timer interval expires.

If you wish to record interval data at predefined intervals without linking to other events, just select a timer as a setpoint trigger and specify in the setpoint actions list a data log file you want to use for recording. If you want the periodic data to be recorded in presence of a specific event, select triggers that identify your event, and then add the timer at the end of the trigger list using the AND operator.

### Using Time Triggers

If you want the setpoint actions to be synchronized with the clock, for example, to provide synchronous recording interval data each 15 minutes or each hour, or to output time pulses through relay contacts, use the time triggers that generate static events synchronized to the device clock.

You can exercise the default setting for Setpoint #1 in your meter as an example of using time triggers. The setpoint is pre-programmed for data profiling at 15-minute intervals using Data logs #1 and #2.

### Delaying Setpoint Operations

Two optional delays can be added to each setpoint to extend monitoring setpoint triggers for a longer time before making a decision on whether the expected event occurred or not. When a delay is specified, the logical controller changes the setpoint status only if all conditions are asserted for a period at least as long as the delay time.

Although a delay can be specified with a 1-ms resolution, the actual value is aligned at a lower 1/2-cycle time boundary.

You cannot use delays with pulsed events since they are cleared immediately and do not longer exist on the next setpoint scan.

### Using Setpoint Events and Actions

When a setpoint status changes, i.e., a setpoint event is either asserted or de-asserted, the following happens in your device:

The new setpoint status is logged to the setpoint status register that can be monitored from the SCADA system or from a programmable controller in order to give an indication on the expected event.

The operated setpoint status is latched to the setpoint alarm latch register, which is remotely accessible. The register holds the last setpoint alarm status until it is explicitly cleared.

Up to four programmable actions can be performed in sequence on setpoint status transition when a setpoint event is asserted.

Generally, setpoint actions are performed independently for each setpoint and can be repeated a number of times for the

same target. The exceptions are relay operations, data logging and waveform logging that are shared between all setpoints using an OR scheme for each separate target.

A relay output is operated when one of the setpoints linked to the relay is activated and stays in the operated state until all of these setpoints are released (except for latched relays that require a separate release command to be deactivated).

Data logging and waveform logging directed to the same file are done once for the first setpoint among those that specify the same action, guaranteeing that there will not be repeated records related to the same time.

### **Recording Setpoint Events**

Time-tagged setpoint events can be recorded to the Event log if you put the corresponding action to the setpoint action list.

If you select to record setpoint operations into the Event log, define in the action target box which transition events you want to be recorded: when the setpoint is operated, when it is released, or both events. The Event recorder puts into a log file a separate record for each active trigger caused a setpoint status transition, and a separate record for each action done on the setpoint activation (except for logging actions that are not recorded to the Event log).

If you run a number of recorders from the same setpoint action list, it is recommended that you put the Event log action before others in order to allow other recorders to use the event sequence number given to the event by the Event recorder.

## Configuring Billing/TOU

The EM720 provides 10 universal billing energy registers that can be linked to any internal energy source or to any external pulse source that delivers pulses through the device digital inputs.

Any of energy registers can provide either a single-tariff energy accumulation or be individually linked to the TOU system providing both total and multi-tariff energy billing. Any of energy registers can be individually linked to the maximum demand and cumulative maximum demand registers providing the same demand tariff structure as you selected for energy registers.

The meter tariff structure supports 8 different tariff rates using an arbitrary tariff schedule. A total of 4 types of days and 4 seasons are supported with up to eight tariff changes per day.

The first four billing registers in your meter are pre-configured at the factory to store imported and exported kWh and imported and exported kvarh. You can change the factory assignments or configure the remaining registers on your selection.

### **To configure billing/TOU registers in your meter:**

1. Link the billing registers to the respective energy sources.
2. Configure the register options, like multi-tariff billing, maximum demand and monthly/daily profiling, for every register you selected.
3. Configure the daily tariff schedule using the TOU daily profiles for all types of days and seasons.
4. Configure the season tariff schedule using the TOU calendar.

## Configuring Billing/Tariff Registers

Select Energy/TOU from the Meter Setup menu.

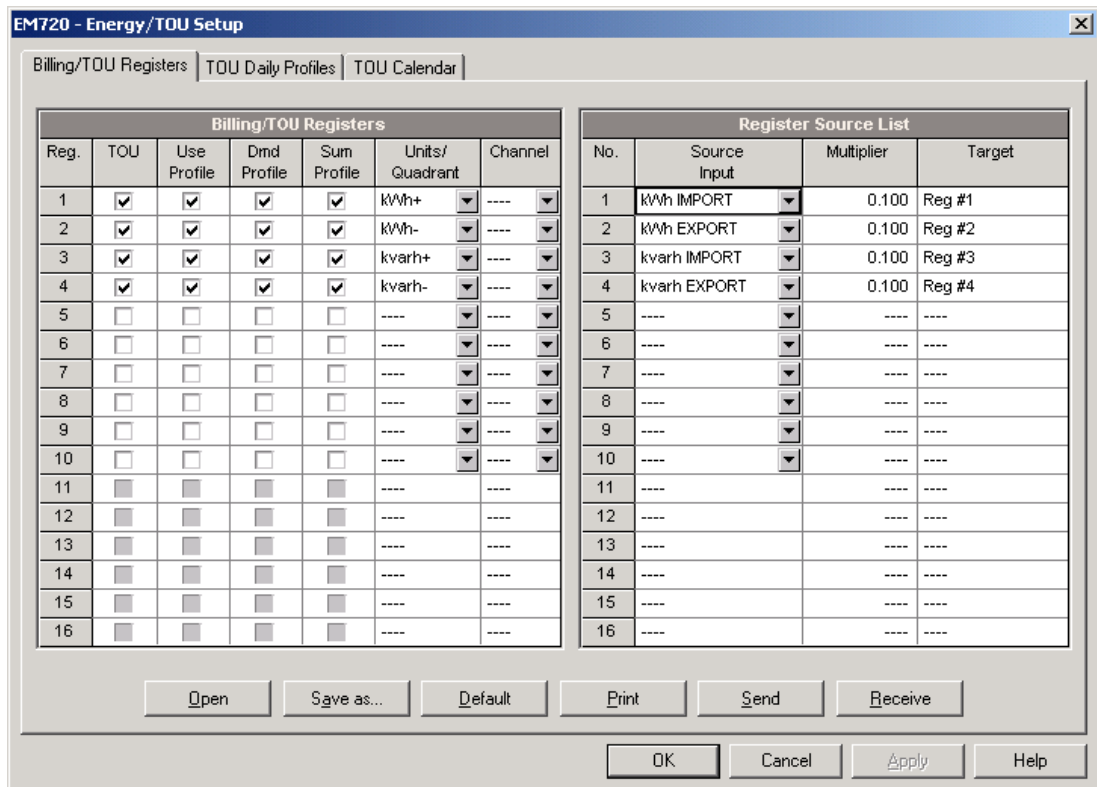

The available options are shown in the following table:

Parameter	Options	Default	Description
<b>Billing/TOU Registers</b>			
TOU	Unchecked Checked	Unchecked	Links multi-tariff registers to the selected energy source
Use Profile	Unchecked Checked	Checked	Enables recording energy registers in monthly/daily billing profile files (both total and tariff registers if TOU is enabled). Always enabled for all configured billing registers.
Dmd Profile	Unchecked Checked	Unchecked	Enables recording maximum demand registers in monthly/daily billing profile files (both total and tariff registers if TOU is enabled)
Sum Profile	Unchecked Checked	Checked	Enables recording total (summary) registers in monthly/daily billing profile files. Always enabled for all configured billing registers.
Units	None kWh+ (import) kWh- (export) kvarh+ (import) kvarh- (export) kvarh Q1 kvarh Q2 kvarh Q3 kvarh Q4 kVAh (total) kVAh+ (import) kVAh- (export)	None	The register measurement unit. Selected automatically for registers linked to internal energy sources. Select an appropriate measurement unit for external pulse sources.

Parameter	Options	Default	Description
Channel	No, Ch1-Ch6	None	Defines a measurement channel for multi-meter energy metering. Not used for a single self-metering channel if there are no external sources. Set to Ch1 for internal energy sources, and to Ch2 through Ch6 for external sources in the event of multi-channel energy metering.
<b>Register Source List</b>			
Source Input	None kWh IMPORT KWh EXPORT kvarh IMPORT kvarh EXPORT kvarh Q1 kvarh Q2 kvarh Q3 kvarh Q4 kVAh TOTAL kVAh IMPORT kVAh EXPORT DI1-DI8	None	Links an internal or external energy source to the billing register.
Multiplier	0.001 to 100.000	1.000	The multiplication factor for the energy source. Not effective for internal sources.
Target	Reg#1- Reg#10	None	Defines the target billing register for the energy source. It is set automatically.

### Configuring the Daily Tariff Schedule

To configure your daily tariff schedule, select Energy/TOU from the Meter Setup menu, and then click on the TOU Daily Profiles tab.

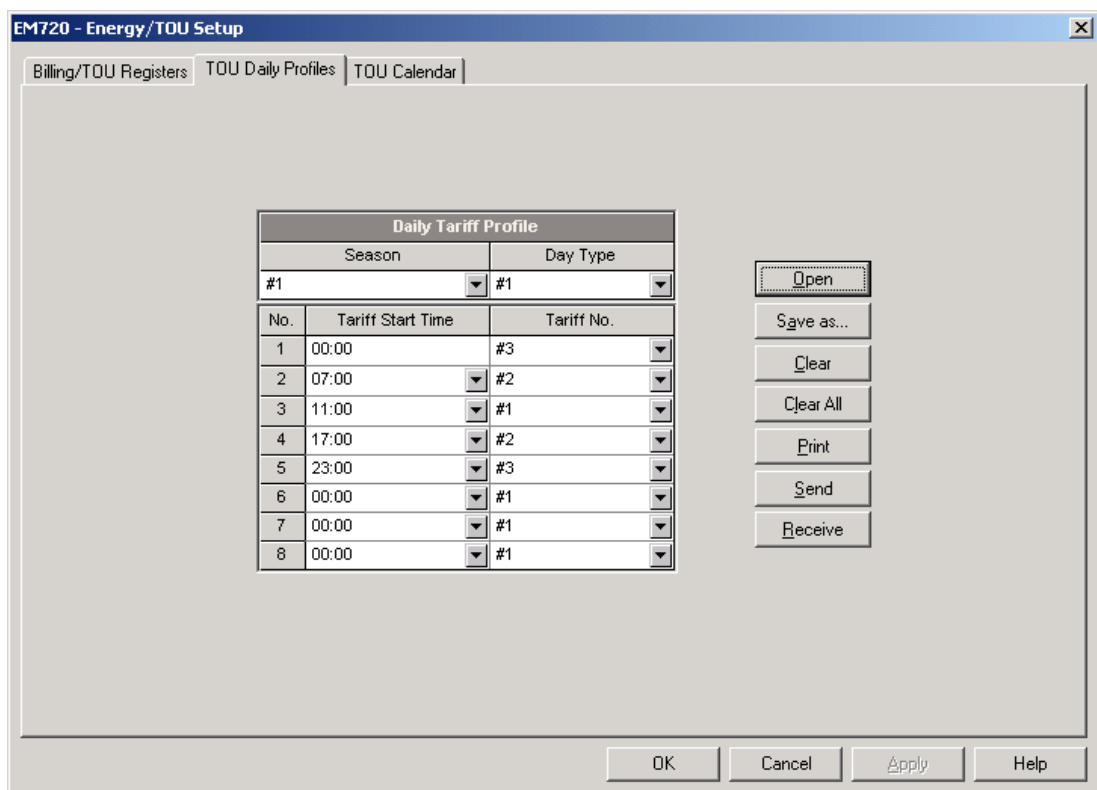

The daily profile setup allows you to specify the daily tariff change points with a 15-minute resolution for 4 seasons using 4 different daily schedules for each season.

**To configure your daily profiles:**

1. Select the desired season and day type.
2. Select the start time for each tariff change point and the corresponding active tariff number.
3. Repeat the setup for all active profiles.

The first tariff change point is fixed at 00:00 hours, and the last tariff change you specified will be in use until 00:00 hours on the next day.

**NOTE**

The billing monthly and daily profile files, and your billing data display are automatically configured for the number of active tariffs you defined in the meter TOU daily profile.

## Configuring the Season Tariff and DST Schedule

The EM720 TOU calendar provides a season tariff schedule and an option for scheduled daylight savings switch dates.

To configure your season tariff schedule, select Energy/TOU from the Meter Setup menu, and then click on the TOU Calendar tab.

No.	Season/ Period	Day Type	Week of Month	Weekday	Till Weekday	Month	Day	Till Month	Till Day	Year
1	#1	#1	----	Monday	Friday	----	----	----	----	----
2	#1	#2	----	Saturday	Sunday	----	----	----	----	----
3	#1	#2	----	----	----	January	1	----	----	----
4	#1	#2	Last	Monday	----	May	----	----	----	----
5	#1	#2	----	----	----	July	4	----	----	----
6	#1	#2	First	Monday	----	September	----	----	----	----
7	#1	#2	Fourth	Thursday	----	November	----	----	----	----
8	#1	#2	----	----	----	December	25	----	----	----
9	----	----	----	----	----	----	----	----	----	----
10	----	----	----	----	----	----	----	----	----	----
11	----	----	----	----	----	----	----	----	----	----
12	----	----	----	----	----	----	----	----	----	----
13	----	----	----	----	----	----	----	----	----	----
14	----	----	----	----	----	----	----	----	----	----
15	----	----	----	----	----	----	----	----	----	----
16	----	----	----	----	----	----	----	----	----	----

The meter TOU calendar allows you to configure any tariff schedule based on any possible utility regulation. The calendar provides 48 entries that allow you to specify profiles for working days and holidays through all seasons in any



order that is convenient for you, based on simple intuitive rules. There are no limitations on how to define your schedule. The meter is able to automatically recognize your settings and to select a proper daily tariff schedule for any day within a year.

The above picture gives you an example of a single-season tariff schedule configured for weekends and the designated U.S.A. holidays.

**To configure your season tariff schedule:**

1. In the "Season/Period" box, select the season, and in the "Day Type" box, select a day type for this calendar entry.
2. Select the time interval when this daily tariff schedule is effective, based on the start and the end weekdays and, for a multi-season schedule, on the start and the end month for the selected season. It does not matter which order of weekdays or months you select: the meter recognizes the correct order.
3. For exception days like designated holidays, select a specific day either by specifying a day and month, or by selecting a month, a week and a weekday within the month.

**NOTE**

The EM720 TOU calendar provides an embedded schedule of Hebrew holidays till 2039 for Israeli customers. To enable the automatic holiday schedule, select Israel in the Country box in the Local Settings setup (see [Local Settings](#)).

**To configure your DST schedule:**

1. Select DST in the "Season/Period" box.
2. Select the DST start month and day in the "Month" and "Day" boxes.
3. Select the DST end month and day in the "Till Month" and "Till Day" boxes.
4. In the "Year" box, select a year for which these dates will be effective.
5. Repeat steps 2-4 for all years for which you wish to provide a DST schedule.

**To make your DST schedule effective:**

1. Go to the Local Settings setup (see [Local Settings](#)).
2. Select "Scheduled" in the Daylight Saving Time (DST) box.
3. Send your new setting to the meter.

## Configuring Recorders

The EM720 is provided with an 8-MByte or 16-MByte flash memory for data, event and waveform recording.

The meter memory is fully configurable except of the files that keep monthly and daily billing profiles and energy load profile. They are pre-configured at the factory and may not be changed by the user.

Two of the data log files are automatically configured in your meter for recording EN51060 compliance statistics data and harmonics survey data. You cannot change the file records structure, but you can still change the amount of memory allocated for these files.

The remaining memory can be freely partitioned. If you wish to change the factory settings, follow the guidelines in the next section.

## Configuring Meter Memory

To view the present memory settings, select Memory/Log from the Meter Setup menu, and then click on the Log Memory tab.

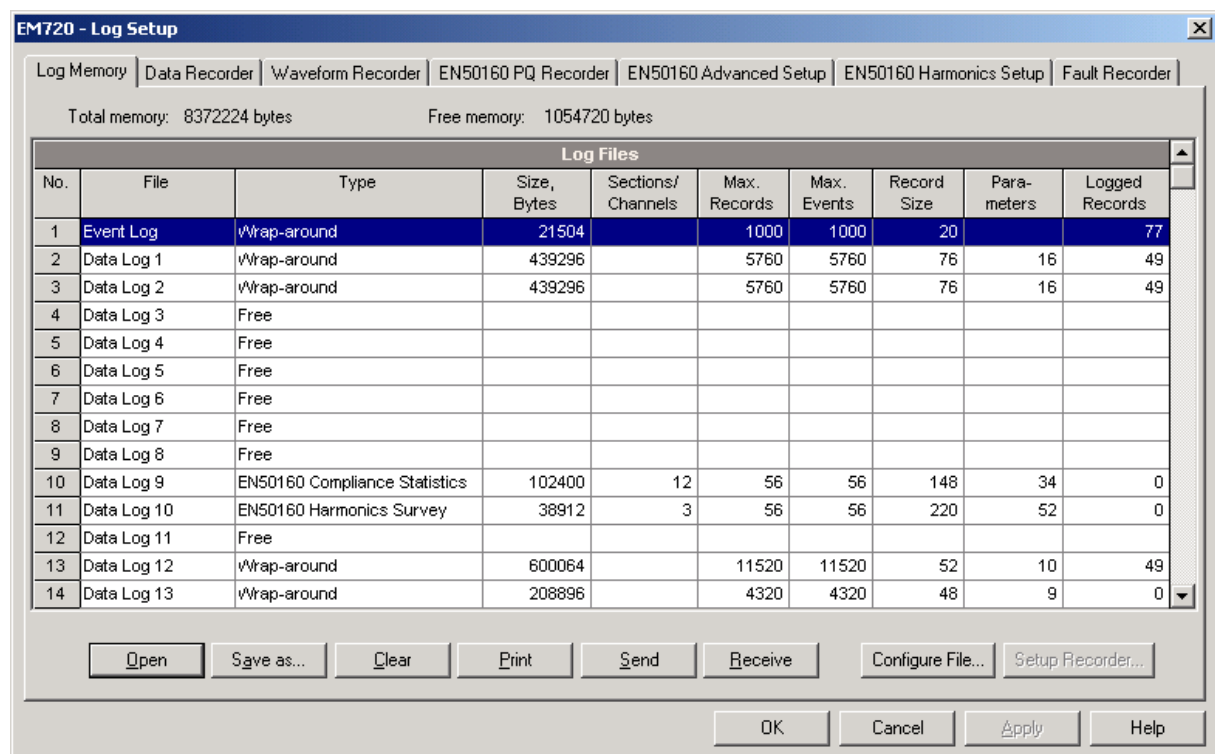

The following table describes file options.

Option	Range	Description
Type	Wrap-around Non-wrap	Wrap-around: recording continues over the oldest records. Non-wrap: recording is stopped until the file is cleared.
Size		The memory size allocated to the file. It is set automatically depending on the size of the records and the number of records in the file.

Option	Range	Description
Sections/Channels	0-20	The numbers of sections in a multi-section profile data log file, or the number of recording channels in a waveform log file
Num. of Records	0-65535	Allocates the file memory for predefined number of records
Record size		The size of the file record for a single channel or a single section. It is set automatically depending on the file and on the number of parameters in the data records
Parameters	0-16	The number of parameters in a single data record

The device memory can be partitioned for a total of 22 log files:

- Event log
- 16 Data logs
- 3 Waveform logs
- EN50160 PQ event log
- Fault event log

Memory is allocated for each file statically when you set up your files and will not change unless you re-organize the files.

**To change the file properties or to create a new file:**

1. Double click on the file you want to change.

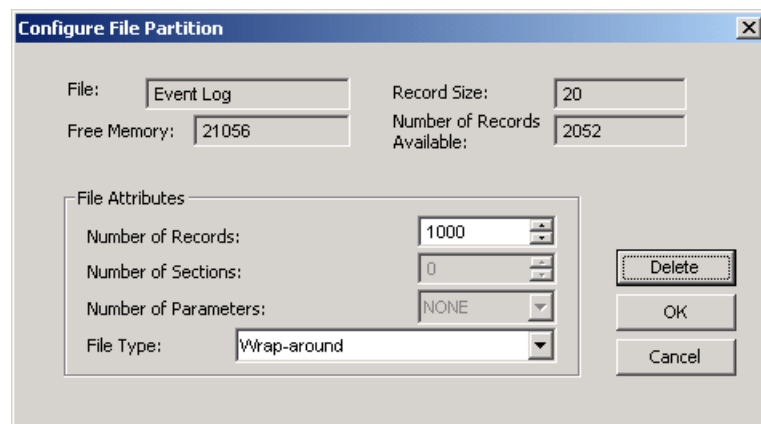

2. Select desired parameters for your log.
3. Click OK.

For your reference, the record size and the number of records available for your file are reported in the dialog box.

**To delete an existing file partition:**

1. Click on Delete.
2. Click OK.

For more information on configuring specific files, see the following sections in this Chapter.

The following table can help you calculate an estimated file size for conventional log files when planning your memory allocation. The actual file size will normally be a bit bigger.

File	Record Size, Bytes	File Size, Bytes
Event Log	20	Record size × Number of records
Conventional Data Log	12 + 4 × Number of parameters	Record size × Number of records
EN50160 Compliance Statistics, Data log #9	148 × 12 channels	Record size × Number of records
EN50160 Harmonics Survey, Data log #10	220 × 3 channels	Record size × Number of records
Waveform Log	1068 × Number of Channels	Record size × Number of series (events) × Number of records per series
EN50160 Power Quality Log	32	Record size × Number of records
Fault Log	40	Record size × Number of records

The meter memory is pre-configured at the factory for common data trending, billing, power quality and fault recording applications as shown in the following table.

No.	File	Size, Bytes	Channels	Number of Records	Number of Events	Factory-set Configuration
1	Event log	21504		1000	1000	
2	Data log #1	439296		5760	5760	Instrumentation 15-min data trending for 60 days
3	Data log #2	439296		5760	5760	Instrumentation 15-min data trending for 60 days
10	Data log #9	102400	12	56	56	EN50160 compliance statistics
11	Data log #10	38912	3	56	56	EN50160 harmonics survey
13	Data log #12	600064		11520	11520	15-min energy load profile for 120 days
14	Data log #13	208896		4320	4320	Fast fault RMS trend
15	Data log #14	191488		4320	4320	Fast PQ RMS trend
16	Data log #15	61440	20	24	24	Monthly Billing/TOU profile for 24 months
17	Data log #16	116736	20	120	120	Daily Billing/TOU profile for 120 days
18	Waveform log #1	3597312	7	480	120	PQ and fault waveforms: 32 samples/cycle × 64 cycles
19	Waveform log #2	906240	7	120	60	PQ waveforms: 128 samples/cycle × 64 cycles
20	Waveform log #3	518144	4	120	60	Fast transient waveforms: 1024 samples/cycle × 1 cycle
27	EN50160 Power Quality log	33792		1000	1000	
28	Fault log	41984		1000	1000	

#### NOTE

The meter automatically performs de-fragmentation of the memory each time you re-organize your files. This prevents possible leakage of memory caused by fragmentation. Depending on the data stored in the memory, it may take from seconds to a couple of minutes.

## Configuring the Event Recorder

### To configure the Event log file:

1. Double click on the Event Log file partition with the left mouse button.

2. Select a desired file type for your file.
3. Select the maximum number of records you want to be recorded in the file.
4. Click OK, then send your new setup to the meter or save to the device database.

By default, the Event recorder stores all events related to configuration changes, resets, and device diagnostics. In addition, it can record events related to setpoint operations. Each setpoint should be individually enabled for recording to the Event log.

To log setpoint operations, add the “Event log” action to the setpoint actions list. When a setpoint event happens, the Event recorder logs all setpoint conditions that caused the event and all setpoint actions performed in response to the event. Logging actions themselves are not recorded to the Event log.

## Configuring the Data Recorder

### Conventional Data Log Files

The Data recorder is programmable for recording up to 16 data parameters per record in each of the conventional data log files. The list of parameters to be recorded to a data log is configurable individually for each file.

### To create a new data log file or re-configure an existing file:

1. Double click on the file partition with the left mouse button.

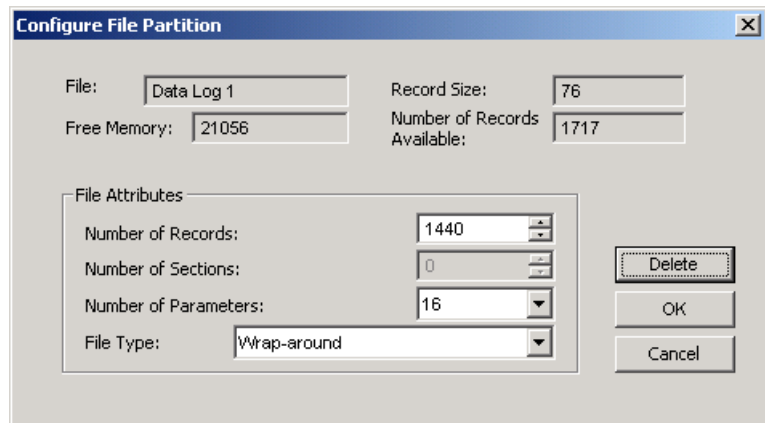

The dialog box 'Configure File Partition' contains the following fields and controls:

- File: Data Log 1
- Record Size: 76
- Free Memory: 21056
- Number of Records Available: 1717
- File Attributes section:
  - Number of Records: 1440
  - Number of Sections: 0
  - Number of Parameters: 16
  - File Type: Wrap-around
- Buttons: Delete, OK, Cancel

2. Select a partition type for your file.
3. Select the number of parameters you want to be recorded in the file records.
4. Select the maximum number of records you want to be recorded in the file.
5. Click OK, and then send your new setup to the meter, or save to the device database.

#### To define the contents of the file:

1. Highlight the data log file row with the left mouse button, and then click on the "Setup Recorder" button, or click on the "Data Recorder" tab and select the corresponding log number.

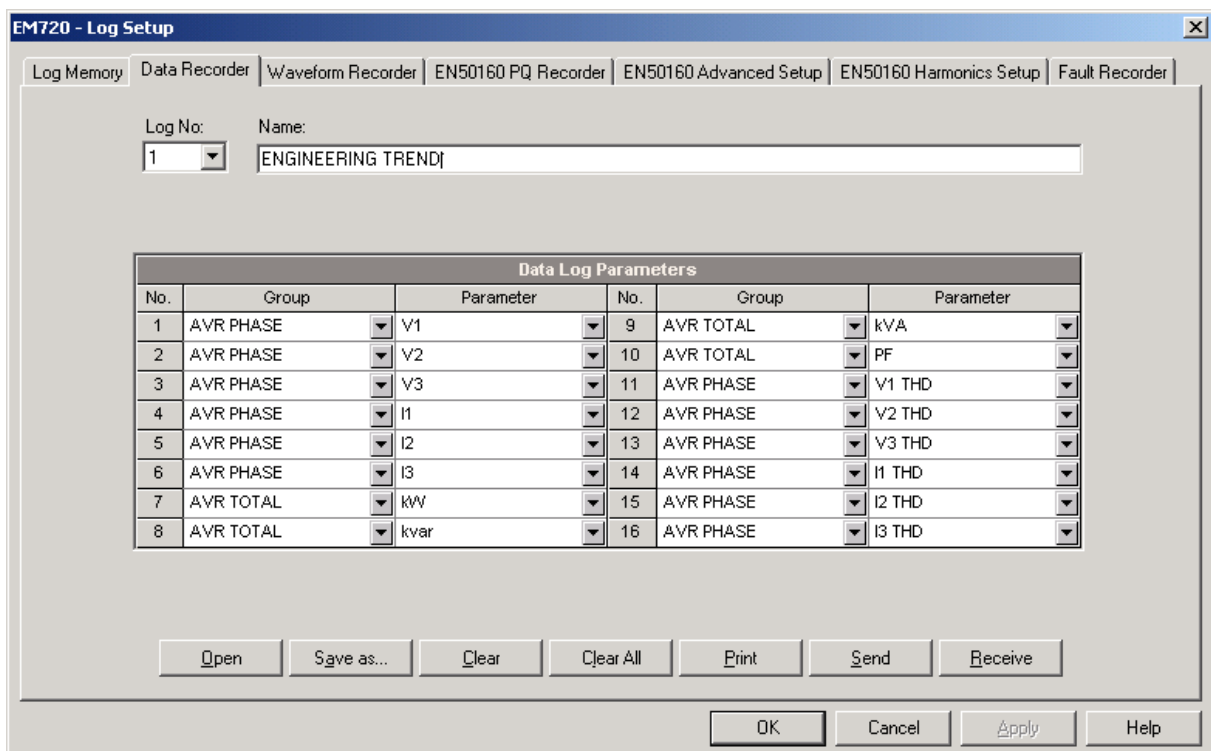

The 'EM720 - Log Setup' dialog box features several tabs: Log Memory, Data Recorder, Waveform Recorder, EN50160 PQ Recorder, EN50160 Advanced Setup, EN50160 Harmonics Setup, and Fault Recorder. The 'Data Recorder' tab is active.

Log No.: 1 | Name: ENGINEERING TREND

Data Log Parameters					
No.	Group	Parameter	No.	Group	Parameter
1	AVR PHASE	V1	9	AVR TOTAL	kVA
2	AVR PHASE	V2	10	AVR TOTAL	PF
3	AVR PHASE	V3	11	AVR PHASE	V1 THD
4	AVR PHASE	I1	12	AVR PHASE	V2 THD
5	AVR PHASE	I2	13	AVR PHASE	V3 THD
6	AVR PHASE	I3	14	AVR PHASE	I1 THD
7	AVR TOTAL	kW	15	AVR PHASE	I2 THD
8	AVR TOTAL	kvar	16	AVR PHASE	I3 THD

Buttons: Open, Save as..., Clear, Clear All, Print, Send, Receive, OK, Cancel, Apply, Help

2. Configure the list of parameters to be recorded in a log file. You are not allowed to select more parameters than you defined when configuring your file. Refer to Appendix A for a list of available parameters.

3. For your convenience, PAS follows your selection and helps you configure a series of the neighboring parameters: when you open the "Group" box for the next parameter, PAS highlights the same group as in your previous selection; if you select this group again, PAS automatically updates the "Parameter" box with the following parameter in the group.
4. Add the name for your data log file in the "Name" box. It will appear in the data log reports.
5. Save your new setup to the device database, and send it to the meter.

## Factory Preset Data Log Files

### Conventional Data Logs

Data log #1 and Data log #2 are factory preset for 15-min periodic recording of the standard power quantities. You can freely change the list of recorded parameters and the update rate for both files.

Periodic recording data to these files is triggered by Setpoint #1 that is linked to the meter clock. To change the periodic rate at which data is recorded, change the time interval for the MINUTE INTERVAL trigger in Setpoint #1 (See [Using Control Setpoints](#) in Chapter 5).

### Data Log #1

Data Log #1 is configured for recording 1-second phase voltages, currents total harmonics, and total powers. The list of parameters is shown in the following table.

Data Log #1	
No.	Parameter
1	V1/V12
2	V2/V23
3	V3/V31
4	I1
5	I2
6	I3
7	Total kW
8	Total kvar
9	Total kVA
10	Total PF
11	V1/V12 THD
12	V2/V23 THD
13	V3/V31 THD
14	I1 THD
15	I2 THD
16	I3 THD

### Data Log #2

Data Log #2 is configured for recording present voltage, current and power demands, engineering (not billing) energy counters, and 1-second neutral current and line frequency. The list of parameters is shown in the following table.

Data Log #2	
No.	Parameter
1	V1/V12 Demand
2	V2/V23 Demand
3	V3/V31 Demand
4	I1 Demand
5	I2 Demand
6	I3 Demand
7	kW Import Sliding Demand
8	kvar Import Sliding Demand
9	KVA Sliding Demand
10	kWh Import
11	kWh Export
12	kvarh Import
13	kvarh Export
14	kVAh
15	In
16	Frequency

### Data Log #13

Data Log #13 is linked to the Fault recorder and is configured for fast 1/2-cycle RMS profiling of fault events. You can freely manipulate this file, as you want. See [Configuring the Fault Recorder](#) in Chapter 5 on how to enable or disable RMS profiling and how to define the maximum duration of the fault RMS profiles.

The factory pre-configured list of parameters for Data log #13 is shown in the following table.

Data Log #13	
No.	Parameter
1	1/2-cycle voltage V1/V12
2	1/2-cycle voltage V2/V23
3	1/2-cycle voltage V3/V31
4	1/2-cycle (neutral/zero-sequence) voltage V4
5	1/2-cycle current I1
6	1/2-cycle current I2
7	1/2-cycle current I3
8	1/2-cycle current I4
9	1/2-cycle zero-sequence voltage

### Data Log #14

Data Log #14 is linked to the Power Quality recorder and is configured for RMS profiling of power quality events. You can freely manipulate this file. See [EN50160 PQ Recorder Setup](#) in Chapter 5 on how to enable or disable RMS profiling and how to define the maximum duration and time envelopes for the PQ RMS profiles.

The factory pre-configured list of parameters for Data log #14 is shown in the following table. The time integration interval for these parameters is dynamically changed as the event continues for more time.



Data Log #14	
No.	Parameter
1	Generic voltage V1/V12
2	Generic voltage V2/V23
3	Generic voltage V3/V31
4	Generic current I1
5	Generic current I2
6	Generic current I3
7	Generic current I4
8	Generic frequency

### EN50160 Statistics Data Logs

Data log #9 and Data log #10 are pre-configured for recording EN50160 compliance statistics and harmonics survey data. See [EN50160 Statistics Log Files](#) in Appendix D for the file layout and contents.

You cannot remove these files or change a file structure, but you can still change the file size if you wish to collect the EN50160 statistics data for more time.

### Monthly and Daily Billing Data Logs

Data log #15 is pre-configured for recording billing period data. It keeps billing energy, maximum demand and cumulative maximum demand for last 24 billing periods. The file is updated at an end of billing period, normally once a month.

Data log #16 is pre-configured for daily billing energy and maximum demand recording for the last 120 days. It is automatically updated once a day.

You cannot manipulate these files and may not reset them unless you have special permissions.

See [Billing and Load Profile Log Files](#) in Appendix C for the file record structure.

### Energy Load Profile Data Log

Data log #12 is pre-configured for recording energy load profile data at 15-minute intervals. The file can keep data for the last 120 days.

You cannot remove the file or change a file structure, but you can still reset the file with an administration password.

Periodic recording data to this file is triggered by Setpoint #16 that is linked to the meter clock. To change the periodic rate at which data is recorded, change the time interval for the MINUTE INTERVAL trigger in Setpoint #16 (See [Using Control Setpoints](#) in Chapter 5).

See [Billing and Load Profile Log Files](#) in Appendix C for the file record structure.

## Configuring the Waveform Recorder

The EM720 can store waveforms in three log files.

Configurable waveform log files #1 and #2 can record waveforms at four programmable sampling rates: 32, 64, 128 or 256 samples per cycle. A log file can store up to 7 channels simultaneously (three voltage channels and four current channels) with a programmable length and up to 20 pre-event cycles.

Waveform log #3 is pre-configured for fast transient recording. It is only operational in the EM720T and stores 1-cycle transient waveforms sampled at a rate of 1024 samples per cycle. If you have a basic EM720 model, you can remove this file to free more memory for other files.

The waveform record length depends on a recording option you can select for each configurable waveform file:

- Fixed recording time: a triggered waveform is recorded up to the maximum specified length. Other events that may be triggered before the recording ends may not be recorded completely if they extend beyond the recording time.
- Event-controlled recording time: a waveform will extend for as long as trigger conditions exist plus a user-defined post-event time of up to 2048 cycles (possibly extended to complete a file record). The maximum length for an active trigger is limited to avoid continuous triggering. The minimum record length can be extended by post-event time if needed.

### NOTE

In event-controlled mode, waveform triggering on end of a PQ or fault event, or by a pulsed event (like a voltage transient or timer-triggered events), which have no duration, can only record minimum-length waveforms that may be extended by a user-defined pre-event and post-event time.

The minimum waveform length that can be recorded is 512 samples of the input signal, or 0.5 to 16 cycles depending on the selected sampling rate. It is the size of physical records the waveform recorder uses to store waveforms to files. Whenever a waveform ends before the last file record is completed, it extends up to the file record size.

If a waveform file is configured to store more samples per event than a single file record can hold, the recorder stores as many records as required for recording the entire event. The file records in a series are identified by the same series number, so they may be easily linked and plotted together.

### To configure a waveform log file:

1. Double click on a waveform log partition with the left mouse button.

Configure File Partition

File: Waveform Log 1      Record Size: 1068  
 Free Memory: 1054720      Number of Records Available: 622

File Attributes

Number of Records: 480  
 Number of Channels: 7  
 Number of Parameters: NONE  
 File Type: Wrap-around

Delete  
 OK  
 Cancel

Number of Events = Number-of-Records / (Samples-per-Cycle x Cycles-per-Series / 512)

2. Select a file type for your file.
3. Select the number of channels for simultaneous recording in the file to define the file record size.
4. Select the maximum number of records you want to be recorded in the file.

The number of records required to store a single waveform series per event is defined as follows:

$$\text{Number of Records per Series} = \frac{\text{Sampling Rate (Samples per Cycle)} \times \text{Number of Cycles per Event}}{512}$$

The total number of records you should allocate to store the required number of events (series) is defined as follows:

$$\text{Number of Records} = \text{Number of Records per Series} \times \text{Number of Series}$$

For example, to record 64-cycle waveforms sampled at a rate of 32 samples per cycle, the number of records required for one waveform series would be:

$$\text{Number of Records per Series} = (32 \times 64) / 512 = 4.$$

To allocate space sufficient to store 20 waveform events (series), the waveform log file should be set up for  $4 \times 20 = 80$  records.

5. Click OK, and save your setup to the site database and then send to the meter.

**To configure the waveform duration, sampling rate and channels to be recorded in the file:**

1. Click on the file you wish to configure to highlight it and then click "Setup Recorder", or click on the "Waveform Recorder" tab.

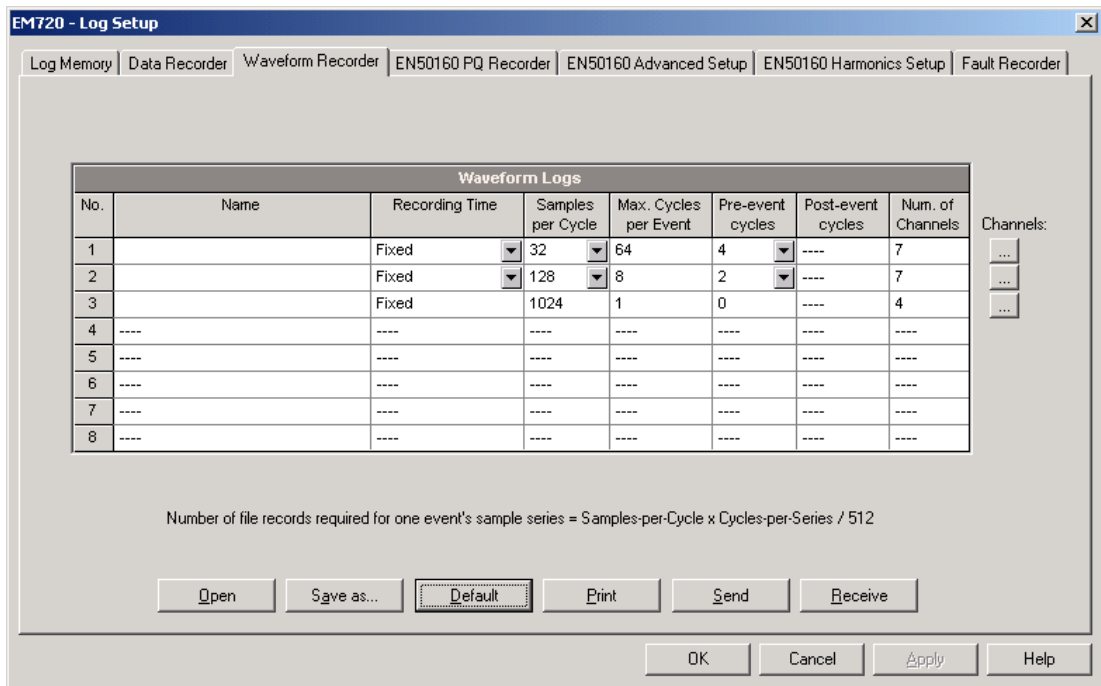

The following table lists available waveform options.

Parameter	Options	Description
Recording Time	Fixed Event-controlled	Fixed – a waveform is recorded up to the maximum specified length Event-controlled – a waveform extends for as long as trigger conditions exist plus post-event time, or up to the maximum specified length
Samples per Cycle	32, 64, 128, 256, 1024	Waveform sampling rate
Max. Cycles per Event	16-10848 at 32 samples/cycle 8-5424 at 64 samples/cycle 4-2712 at 128 samples/cycle 2-1356 at 256 samples/cycle 1 at 1024 samples/cycle	The maximum waveform length per event in cycles including pre-event and post-event time
Pre-event Cycles	1-20	Pre-event time in cycles to be recorded prior to event
Post-event Cycles	0-2048	Post-event time in cycles to be recorded after end of event in event-controlled mode
Num. of Channels	1-7	The number of simultaneously recorded channels (informative)

2. Select the recording mode and parameters for your waveform file.
3. Add the name for your file in the "Name" box. It will appear in the waveform reports.
4. To select the AC channels, click on the Channels button, check the boxes for channels you want to be recorded, and then click OK.

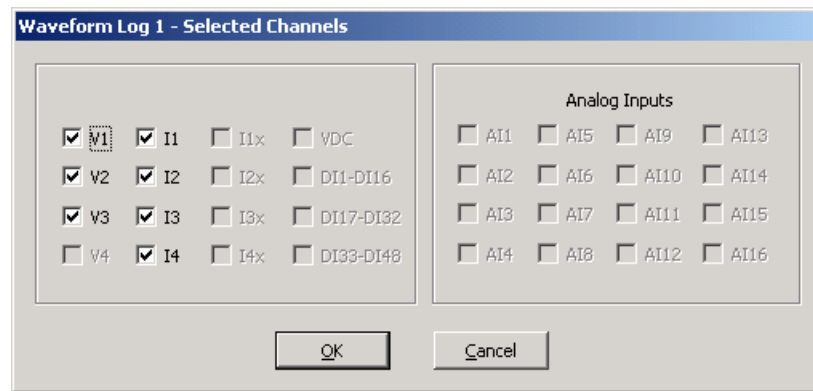

5. Save your waveform setup to the device database, and then send it to the meter.

## Configuring the Fault Recorder

The Fault recorder automatically records all fault events to the Fault log file. It can be triggered via the embedded fault detector, or externally through any of the 8 digital inputs.

The Fault recorder can be globally disabled or enabled in your meter.

The Fault recorder setup allows you to adjust thresholds and hysteresis for different fault triggers, and to define the waveform and data log options for synchronous recording during fault events.

### To configure the Fault recorder:

1. Select Memory/Log from the Meter Setup menu, and then click on the Fault Recorder tab.

**EM720 - Log Setup**

Log Memory | Data Recorder | Waveform Recorder | EN50160 PQ Recorder | EN50160 Advanced Setup | EN50160 Harmonics Setup | **Fault Recorder**

Fault Triggers										
Fault Event	Trigger #1	Threshold, %	Threshold, secondary	Hysteresis, %	Trigger Enabled	Trigger #2	Threshold, %	Threshold, secondary	Hysteresis, %	Trigger Enabled
DI	External Trigger	----	----	----	<input checked="" type="checkbox"/>	----	----	----	----	<input type="checkbox"/>
FE1	Zero-Seq. Current	5.0	0.25 A	5.0	<input type="checkbox"/>	----	----	----	----	<input type="checkbox"/>
FE2	Zero-Seq. Voltage	5.0	11.5 V	5.0	<input type="checkbox"/>	----	----	----	----	<input type="checkbox"/>
FE3	Current Unbalance	5.0	----	5.0	<input type="checkbox"/>	----	----	----	----	<input type="checkbox"/>
FE4	Voltage Unbalance	5.0	----	5.0	<input type="checkbox"/>	----	----	----	----	<input type="checkbox"/>
FE5	Overcurrent	150.0	7.50 A	5.0	<input checked="" type="checkbox"/>	Undervoltage	90.0	207.9 V	5.0	<input checked="" type="checkbox"/>
FE6	Undervoltage	90.0	207.9 V	5.0	<input type="checkbox"/>	----	----	----	----	<input type="checkbox"/>
FE7	I4 (neutral) Current	5.0	0.25 A	5.0	<input type="checkbox"/>	----	----	----	----	<input type="checkbox"/>

Fault Recording							
Waveform Log			1/2-cycle RMS Trend				
Log on Start	Log on End	Log No.	Log Enabled	Max. Duration, Cycles	Before, Cycles	After, Cycles	Data Log No.
<input checked="" type="checkbox"/>	<input type="checkbox"/>	1	<input type="checkbox"/>	100	4	4	13

Recorder Enabled  
 Record to PQ Log

Open Save as... Default Print Send Receive

OK Cancel Apply Help

2. Enable fault triggers suitable for your application.
3. If you wish to change the default settings, adjust thresholds and hysteresis for your fault triggers.
4. Select the waveform and data logging options for fault events.
5. Download your setup to the device.

The following table lists available Fault recorder options.

Option	Range	Default	Description
<b>Thresholds</b>			
Threshold, %	0-200.0%		Defines the operating threshold for a fault trigger in percent of the nominal (reference) value
Threshold, secondary			Shows the setup value in secondary units for the selected operating threshold

Option	Range	Default	Description
Hysteresis, %	0-50.0%	5.0	Defines the hysteresis for a fault trigger in percent of the threshold
Trigger Enabled	Checked Unchecked	Checked	Links a fault trigger to the Fault Recorder. If the box is unchecked, the Fault Recorder does not respond to the trigger.
<b>Waveform Log</b>			
On Start	Checked Unchecked	Checked	Enables waveform log when the fault event starts
On End	Checked Unchecked	Unchecked	Enables waveform log when the fault event ends
Log No.	1-8	7	Specifies the waveform log file used for waveform recording on the fault event
<b>1/2-cycle RMS Trend</b>			
Log Enabled	Checked Unchecked	Unchecked	Enables recording of the RMS profile during a fault event
Max. Duration	0-10,000 cycles	100	Maximum duration of the RMS profile log at a 1/2-cycle rate. The logging is stopped automatically when either a fault event ends or the specified number of cycles has been recorded.
Before, Cycles	0-20 cycles	4	The number of cycles to be recorded prior to the event
After, Cycles	0-20 cycles	4	The number of cycles to be recorded after the event
Log No.	13	13	Specifies the data log file used for data recording on the fault event

**To enable or disable the Fault recorder in your meter:**

1. Check or uncheck the "Recorder Enabled" checkbox.
2. Send the new setting to the device.

### Configuring Analog Triggers

Voltage and current thresholds are normally specified as a percent of a nominal (reference) voltage and current. The voltage reference is the line-to-neutral PT secondary voltage for the 4LN3 and 3LN3 wiring configurations, and the line-to-line PT secondary voltage for other wiring configurations. The reference value for current triggers is the CT secondary current rating. See [Basic Device Setup](#) in Chapter 5 for information on specifying voltage and current ratings in your device.

To make easier specifying thresholds for voltage and current triggers, PAS shows you threshold values in secondary units that match the percentage you selected for the triggers. To update the secondary thresholds, type the threshold for a trigger in percent, and then press Enter or click elsewhere on the Fault recorder setup tab.

The picture above shows the factory set Fault recorder options. Notice that the Overcurrent trigger can be used along with the second Undervoltage trigger combined by logical AND. If you wish to use the only Overcurrent trigger, disable (uncheck) the second Undervoltage trigger.

The **Zero-Sequence Voltage** trigger and the **Voltage Unbalance** trigger are disabled by default. Both are very sensitive to phase unbalances. If you want to use them,

adjust the thresholds according to your network conditions before enabling triggers.

The **Current Unbalance** trigger has a different calculation algorithm than the common current unbalance measurements. Since the unbalance readings give a relation of the maximum deviation from the average to the phase average current, the value could produce high readings for low currents. The Current Unbalance trigger used with the Fault recorder indicates a relation to the CT rated current and is not sensitive to low currents.

### Configuring Digital Triggers

If you use external triggering through digital inputs, you should individually link each digital input to the Fault recorder (see [Configuring Digital Inputs](#) in Chapter 5).

### Fault Indication and Cross Triggering

When the Fault recorder is triggered either by the fault detector or through digital inputs, it generates a number of specific internal events that can be monitored through the control setpoints to give a fault indication via relay contacts. The following describes fault events produced by the Fault recorder:

**FAULT DETECTED** - the fault detector has detected a fault event using the device's own measurements

**EXTERNAL TRIGGER** - the Fault recorder has been launched by an external trigger through one of the digital inputs

**FAULT EVENT** - the Fault recorder has been launched either by its own fault detector, or by an external trigger

These events can be found under the **STATIC EVENTS** group in the setpoint trigger list (**STATIC** in this context means that an event is asserted all the time while its fault condition exists).

The **FAULT DETECTED** event can be effectively used for cross triggering multiple fault recorders to simultaneously record fault data at different locations when one of the devices detects a fault. Each device should have a setpoint programmed to close relay contacts on the **FAULT DETECTED** event, and one digital input linked to the Fault recorder.

To provide cross triggering, the triggering digital inputs of all devices should be tied together and connected to the normally opened relay contacts that indicate a fault. To avoid self-triggering through its own digital input for the device that indicates a fault, it is recommended to use a Form C relay and to connect the digital input through the normally closed contacts. Thus, the device that indicates a fault disconnects its digital input before giving a fault out.



## Configuring the EN50160 Recorders

See [EN50160 Evaluation and Recording](#) in Appendix E for information on EN50160 evaluation techniques.

### Basic Device Settings

The following device settings affect the EN50160 evaluation and should be checked prior to running the EN50160 recorders.

#### Reference Voltage

As the general approach of the EN50160, all voltage characteristics are referenced to the nominal voltage that shall be specified in your meter before running the EN50160 recorders (see [Basic Meter Setup](#)). The nominal voltage refers to the line-to-neutral supply voltage in LV networks (4LN3 or 3LN3 wiring modes), and to line-to-line voltage in MV networks (4LL3, 3LL3, 3OP2, 3OP3 and 3DIR2 wiring modes).

#### Reference Frequency

The nominal line frequency is used as a reference for the evaluation of power frequency variations. It should be specified in your meter before running the EN50160 recorders (see [Basic Meter Setup](#)).

### EN50160 Log Files

#### EN50160 Compliance Statistics Log

Data log file #9 is automatically configured in the EM720 for recording EN50160 compliance statistics. Appendix D lists parameters recorded to the file. The file is arranged as a multi-section data log file where each voltage characteristic statistics is stored in a separate section. Along with EN50160 compliance statistics recorded at the end of each evaluation period, file also contains data that may be useful for trouble-shooting power quality problems for non-compliant voltage characteristics.

You can upload and view the EN50160 compliance statistics data via PAS reports or via common PAS data logs views.

#### EN50160 Harmonics Survey Log

Data log file #10 is automatically configured in the EM720 for recording harmonics survey statistics on a weekly or daily basis. You can see parameters recorded to the file in Appendix D. The file stores maximum THD (total, odd and even harmonics) and maximum harmonic voltages up to order 50 collected within each evaluation period.

Harmonics survey is normally intended for trouble-shooting harmonic problems throughout electrical networks. It can be separately disabled or enabled in your meter via the EN50160 Advanced Setup. The evaluation period for harmonics survey

can be selected independently from the EN50160 compliance evaluation.

You can upload and view the harmonics survey data collected by your device via PAS reports or via common PAS data logs views.

### EN50160 Power Quality Event Log

The EM720 provides the EN50160 Power Quality (PQ) recorder that can detect EN50160 incidents and record each individual power quality event to the log file with the start and end timestamps and a fault magnitude. It may be useful for trouble-shooting problems throughout the electrical network, for example, to identify and locate the source of a power quality event and to select an appropriate solution.

The EN50160 power quality report can be uploaded and viewed via PAS (see [Viewing EN50160 Power Quality Event Log](#)). Transient overvoltages and short-duration voltage dips and temporary overvoltages recorded to the file can also be viewed in PAS as magnitude/duration pairs on the well-known ITIC curve chart for assessing the minimum equipment immunity.

The PQ recorder is programmable to trigger the waveform recorder to record the fault waveforms before, during and after the PQ event for detailed event analysis.

### EN50160 Evaluation Limits and Options

Limits for evaluation of the EN50160 voltage characteristics can be set via the [EN50160 PQ Recorder Setup](#) and, for harmonic and interharmonic voltages, via the EN50160 Harmonics Setup (see [EN50160 Harmonics Limits Setup](#)).

The EN50160 evaluation options can be changed via the [EN50160 Advanced Setup](#).

#### EN50160 Logging Options

The memory allocated in your meter for the EN50160 compliance statistics and harmonics survey data is sufficient for 13-month data recording on a weekly basis. The Power Quality event log file is configured for 1000 event records. You can increase or change the size of the EN50160 data log files in your meter via the Log Memory Setup (see [Configuring the Data Recorder](#)).

### EN50160 PQ Recorder Setup

The PQ recorder setup allows you to adjust the EN50160 evaluation limits for specific voltage characteristics in the event the customer requirements differ from the values provided by the EN50160, and to select options for event, waveform and RMS profile recording.

PQ Events and Recording														
Event Category	PQ Log			Waveform Log			Data/RMS Trend - Time Envelopes and Maximum Durations							
	Thresh-old,%	Hyste-resis,%	Ena-bled	On Start	On End	Log No.	Ena-bled	1/2-cyc, cycles	0.2-sec, seconds	3-sec, minutes	10-min, hours	Before, cycles	After, cycles	Log No.
Power Frequency, dF/Fn	1.0	5.0	<input checked="" type="checkbox"/>	<input type="checkbox"/>	<input type="checkbox"/>	1	<input type="checkbox"/>	----	----	3	----	----	----	14
Voltage Variations, dV/Un	10.0	2.0	<input checked="" type="checkbox"/>	<input type="checkbox"/>	<input type="checkbox"/>	1	<input type="checkbox"/>	----	----	----	3	----	----	14
Rapid Voltage Changes, dV/Un	6.0	2.0	<input checked="" type="checkbox"/>	<input type="checkbox"/>	<input type="checkbox"/>	1	<input type="checkbox"/>	----	----	----	----	----	----	----
Flicker Severity, PIt	1.0	5.0	<input checked="" type="checkbox"/>	<input type="checkbox"/>	<input type="checkbox"/>	1	<input type="checkbox"/>	----	----	----	3	----	----	14
Voltage Dips, %Un	90.0	2.0	<input checked="" type="checkbox"/>	<input checked="" type="checkbox"/>	<input type="checkbox"/>	1	<input type="checkbox"/>	30	3	3	0	2	2	14
Voltage Interruptions, %Un	1.0	5.0	<input checked="" type="checkbox"/>	<input checked="" type="checkbox"/>	<input type="checkbox"/>	1	<input type="checkbox"/>	30	3	3	0	2	2	14
Temporary Overvoltages, %Un	110.0	2.0	<input checked="" type="checkbox"/>	<input checked="" type="checkbox"/>	<input type="checkbox"/>	1	<input type="checkbox"/>	30	3	3	0	2	2	14
Transient Overvoltages, %Un	150.0	2.0	<input checked="" type="checkbox"/>	<input checked="" type="checkbox"/>	<input type="checkbox"/>	2	<input type="checkbox"/>	----	----	----	----	----	----	----
Voltage Unbalance, %	2.0	5.0	<input checked="" type="checkbox"/>	<input type="checkbox"/>	<input type="checkbox"/>	1	<input type="checkbox"/>	----	----	----	3	----	----	14
Harmonic THD, %	8.0	5.0	<input checked="" type="checkbox"/>	<input type="checkbox"/>	<input type="checkbox"/>	2	<input type="checkbox"/>	----	----	----	3	----	----	14
Harmonic Voltage, %Un	----	5.0	<input checked="" type="checkbox"/>	<input type="checkbox"/>	<input type="checkbox"/>	2	<input type="checkbox"/>	----	----	----	3	----	----	14
Interharmonic THD, %	2.0	5.0	<input type="checkbox"/>	<input type="checkbox"/>	<input type="checkbox"/>	2	<input type="checkbox"/>	----	----	----	3	----	----	14
Interharmonic Voltage, %Un	----	5.0	<input type="checkbox"/>	<input type="checkbox"/>	<input type="checkbox"/>	2	<input type="checkbox"/>	----	----	----	3	----	----	14
Mains Signaling Voltage, %Un	----	2.0	<input type="checkbox"/>	<input type="checkbox"/>	<input type="checkbox"/>	2	<input type="checkbox"/>	----	----	3	----	----	----	14

Recorder Enabled                       

#### To configure the PQ recorder:

1. Select Memory/Log from the Meter Setup menu, and then click on the EN50160 PQ Recorder tab.
2. Adjust thresholds and hysteresis for PQ triggers if required. The harmonic and interharmonic voltage limits can be individually set for each harmonic order via the EN50160 Harmonics Setup. Limits for the signaling voltage frequencies are automatically taken from the "Meister-curve".
3. Check the Enabled box for the voltage characteristics you want to be recorded to the PQ event log. You can individually enable or disable recording PQ events related to specific characteristics. Notice that the interharmonic voltage and mains signaling voltage evaluation should be also enabled in the meter via the EN50160 Advanced Setup.
4. Disabling recording events to the PQ log does not prevent the evaluation of the voltage characteristics and collecting the EN50160 statistics for these events.
5. Select the waveform and RMS profile logging options for PQ events.
6. Download your setup to the device.

The picture above shows the default PQ recorder settings. The available options are listed in the following table.

Option	Range	Default	Description
<b>PQ Log</b>			
Threshold, %	0-200.0%		Defines the operating threshold for a PQ trigger in percent of the nominal (reference) value
Hysteresis, %	0-50.0%	5.0	Defines the hysteresis for a PQ trigger in percent of the threshold
Enabled	Checked Unchecked		Enables recording PQ events for a specific voltage characteristic
<b>Waveform Log</b>			
On Start	Checked Unchecked	Checked	Enables waveform log when a PQ event starts
On End	Checked Unchecked	Unchecked	Enables waveform log when a PQ event ends
Log No.	1-2		Specifies the waveform log file used for waveform recording on a PQ event
<b>Data/RMS trend – Time envelopes and Maximum Durations</b>			
Enabled	Checked Unchecked	Unchecked	Enables recording of the RMS profile during a fault event
1/2-cyc, cycles	0-1000 cycles	30	Maximum duration of the RMS profile log at a 1/2-cycle rate.
0.2-s, seconds	0-1000 s	3	Maximum duration of the RMS profile log at a 0.2-second rate.
3-s, minutes	0-1000 minutes	3	Maximum duration of the RMS profile log at a 3-second rate.
10-min, hours	0-1000 hours	3	Maximum duration of the RMS profile log at a 10-minute rate.
Before, Cycles	0-20 cycles	4	The number of cycles to be recorded prior to the event
After, Cycles	0-20 cycles	4	The number of cycles to be recorded after the event
Log No.	14	14	Specifies the data log file used for data recording on the fault event

Waveform log options allow recording waveforms both at the start and at the end of an event. Since voltage variations can last from some seconds to minutes, this allows recording voltage transitions at the beginning and at the end of a voltage dip or overvoltage using shorter waveforms.

RMS profiling options allow long-duration recording of RMS voltages and currents while the event continues, using a variable recording rate and variable averaging intervals.

#### NOTES

1. The low threshold for detecting transient overvoltages is specified in percent of the nominal voltage amplitude ( $1.414 U_n$ ), either as a peak value (from 120%), or as the impulse amplitude (from 20%), depending on the option you selected in the [EN50160 Advanced Setup](#).
2. In meters with the fast transient recorder option (EM720T), the low threshold for transient overvoltages is limited to 40V. Although you can specify lower values, the meter will automatically limit it at 40V.
3. With the fast transient recorder option, a one-cycle transient voltage waveform is automatically recorded to Waveform log #3. If you also enable recording conventional waveforms to Waveform log #1 or #2 for

the PQ recorder, then a second longer waveform will be also recorded, synchronized with the fast transient waveform.

You can temporary disable the PQ recorder in your device.

**To enable or disable the PQ recorder:**

1. Check or uncheck the Recorder Enabled checkbox.
2. Send your setting to the device.

Note that disabling the PQ recorder in your meter does not affect the evaluation and recording of the EN50160 statistics.

**Indication of Power Quality Events**

When the PQ recorder detects a power quality fault, it generates the specific internal event "PQ EVENT" that can be monitored through a control setpoint. The event is asserted all the time while the fault condition exists. The "PQ EVENT" trigger is used to give a power quality fault indication via relay contacts, or can be combined using the AND operator with timer ticks for periodic data recording at the time of the fault to produce voltage trending charts.

## EN50160 Harmonics Limits Setup

This setup allows you to adjust compliance limits for harmonic and interharmonic voltages.

**To change the default limits in your device:**

1. Select Memory/Log from the Meter Setup menu, and then click on the EN50160 Harmonics Setup tab.

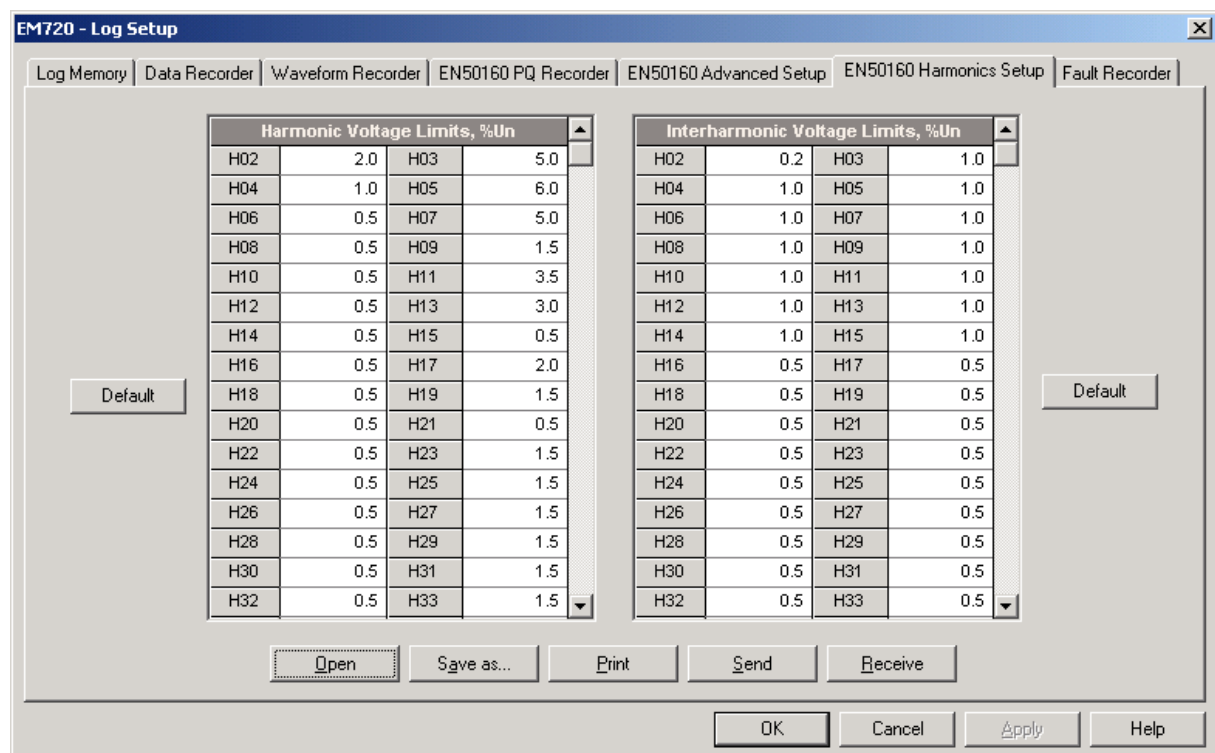

2. Adjust limits you want to change.

- Download your setup to the device.

The default EN50160 compliance limits are shown in the picture above. You can change the number of the evaluated harmonics and interharmonics via the [EN50160 Advanced Setup](#).

## EN50160 Advanced Setup

The EN50160 Advanced Setup allows you to configure the EN50160 evaluation options in your meter.

### To configure the EN50160 evaluation options:

- Select Memory/Log from the Meter Setup menu, and then click on the EN50160 Advanced Setup tab.
- Change the EN50160 evaluation options if required.
- Download your setup to the device.

The default EN50160 evaluation options set in your device are shown in the picture below.

The screenshot shows the 'EN50160 Advanced Setup' tab in the 'EM720\_204\_SAT - Log Setup' dialog. The 'Default' button is highlighted. The configuration options are as follows:

EN50160 Compliance Statistics	
Evaluation	Enabled
Evaluation Period	Weekly
First Day of the Week	Sunday
EN50160 Harmonics Survey	
Evaluation	Enabled
Evaluation Period	Weekly
Rapid Voltage Changes	
Repetition Rate, variations/hour [1-10]	1
Flicker	
Pst Period [1-10 min]	10
Harmonic Voltage	
THD, up to order [25-50]	40
Harmonics, up to order [25-50]	25
Interharmonic Voltage	
Evaluation	Disabled
THD, up to order [25-50]	40
Interharmonics, up to order [25-50]	25
Mains Signaling Voltage	
Evaluation	Disabled
1st Signaling Frequency, Hz	183.0
2nd Signaling Frequency, Hz	191.0
3rd Signaling Frequency, Hz	217.0
4th Signaling Frequency, Hz	317.0
Transient Overvoltage	
Detection and Classification Method	Peak voltage

The available options are listed in the following table.

Option	Range	Default	Description
<b>EN50160 Compliance Statistics</b>			
Evaluation	Disabled, Enabled	Enabled	Enables the EN50160 evaluation
Evaluation Period	Daily, Weekly	Weekly	Defines the EN50160 statistics evaluation period
First Day of the Week	Sunday-Saturday	Sunday	Defines the first day of the week for statistics evaluated on a weekly basis
<b>EN50160 Harmonics Survey</b>			
Evaluation	Disabled, Enabled	Enabled	Enables the harmonics survey log
Evaluation Period	Daily, Weekly	Weekly	Defines the harmonics survey evaluation period

Option	Range	Default	Description
<b>Rapid Voltage Changes</b>			
Repetition Rate	1-10	1	Defines the maximum repetition rate in variations per hour (equal or less than) for rapid voltage changes. Voltage changes at higher rates are not classified since they will be subject for flicker.
<b>Flicker</b>			
Pst Period	1-10 min	10 min	Defines the period of time for the short-term flicker evaluation. The standard setting of 10 minutes can be temporarily changed in the device for testing purposes.
<b>Harmonic Voltage</b>			
THD, up to order	25-50	40	Defines the highest harmonic order included in the THD evaluation.
Harmonics, up to order	25-50	25	Defines the highest harmonic order for evaluation of the harmonic voltages.
<b>Interharmonic Voltage</b>			
Evaluation	Disabled, Enabled	Disabled	Enables the evaluation of the interharmonic voltages
THD, up to order	25-50	40	Defines the highest interharmonic order included in the THD evaluation.
Interharmonics, up to order	25-50	25	Defines the highest harmonic order for evaluation of the interharmonic voltages.
<b>Mains Signaling Voltage</b>			
Evaluation	Disabled, Enabled	Disabled	Enables the evaluation of the mains signaling voltages
1st Signaling Frequency	110-3000 Hz	183.0 Hz	Specifies the mains signaling frequency for the compliance evaluation
2nd Signaling Frequency	110-3000 Hz	191.0 Hz	Specifies the mains signaling frequency for the compliance evaluation
3rd Signaling Frequency	110-3000 Hz	217.0 Hz	Specifies the mains signaling frequency for the compliance evaluation
4th Signaling Frequency	110-3000 Hz	317.0 Hz	Specifies the mains signaling frequency for the compliance evaluation
<b>Transient Overvoltage</b>			
Detection and Classification Method	Peak voltage Impulsive voltage	Peak voltage	Defines the method for detecting and classifying transient overvoltages: Peak voltage – transient overvoltages are classified by the peak voltage; Impulsive voltage - transient overvoltages are classified by the impulse amplitude.

## Clearing EN50160 Evaluation Counters

See [Resetting Accumulators and Log Files](#) in Chapter 6 on how to clear the present contents of the EN50160 evaluation counters before starting your EN50160 evaluation.

## Configuring Communication Protocols

This section describes how to customize protocol options for use with your application software.

### Configuring Modbus

#### Modbus Point Mapping

The EM720 provides 120 user assignable registers in the address range of 0 to 119. You can re-map any register available in the device to any assignable register so that Modbus registers that reside at different locations may be simply accessed using a single request by re-mapping them to adjacent addresses.

Initially these registers are reserved and none of them points to an actual data register.

#### To build your own Modbus register map:

1. From the Meter Setup menu select Protocol Setup and click on the Modbus Registers tab.
2. Click on the Default button to cause the assignable registers to reference the actual default device register 11776 (0 through 119 are not allowable register addresses for re-mapping).
3. Type in the actual addresses you want to read from or write to via the assignable registers. Refer to the EM720 Modbus Reference Guide for a list of the available registers. Note that 32-bit Modbus registers should always start at an even register address.

**EM720 - Protocol Setup**

Modbus Registers | DNP Options | DNP Event Setpoints | DNP Class 0 Points

Assignable Registers											
Reg	Addr. [dec]	Reg	Addr. [dec]	Reg	Addr. [dec]	Reg	Addr. [dec]	Reg	Addr. [dec]	Reg	Addr. [dec]
0	14336	20	3088	40	3120	60	11776	80	11776	100	11776
1	14337	21	3089	41	3121	61	11776	81	11776	101	11776
2	14720	22	3090	42	44378	62	11776	82	11776	102	11776
3	14721	23	3091	43	44379	63	11776	83	11776	103	11776
4	14728	24	3092	44	56192	64	11776	84	11776	104	11776
5	14729	25	3093	45	56193	65	11776	85	11776	105	11776
6	19584	26	3096	46	56194	66	11776	86	11776	106	11776
7	19585	27	3097	47	56195	67	11776	87	11776	107	11776
8	19586	28	3102	48	56196	68	11776	88	11776	108	11776
9	19587	29	3103	49	56197	69	11776	89	11776	109	11776
10	11776	30	3104	50	56452	70	11776	90	11776	110	11776
11	11776	31	3105	51	56453	71	11776	91	11776	111	11776
12	11776	32	3106	52	56454	72	11776	92	11776	112	11776
13	11776	33	3107	53	56455	73	11776	93	11776	113	11776
14	11776	34	3110	54	56456	74	11776	94	11776	114	11776
15	11776	35	3111	55	56457	75	11776	95	11776	115	11776
16	11776	36	3116	56	44378	76	11776	96	11776	116	11776
17	3076	37	3117	57	44379	77	11776	97	11776	117	11776
18	3082	38	3118	58	11776	78	11776	98	11776	118	11776
19	3083	39	3119	59	11776	79	11776	99	11776	119	11776

Conversion Scales	
Raw Scale Low	0
Raw Scale High	9999
32-bit Analog Reg	Integer
32-bit Counters	Integer
32-bit Energy Reg	Integer

Open  
Save as...  
Default  
Print  
Send  
Receive

OK Cancel Apply Help



- Click Send to download your setup to the device.

## Configuring DNP3

DNP Options can be changed both via DNP3 and Modbus. Refer to the EM720 DNP3 Reference guide for information on the protocol implementation and a list of the available data points.

### DNP Options

From the Meter Setup menu select Protocol Setup and click on the DNP Options tab.

The following table describes available DNP options. Refer to the DNP3 Data Object Library document available from the DNP User's Group on the DNP3 object types.

Parameter	Options	Default	Description
<b>Binary Inputs (BI)</b>			
Number of BI to Generate events	0-64 <sup>3</sup>	21	The total number of BI change event points for monitoring
Binary Input Object	Single-bit With Status	Single-bit	The default BI object variation for requests with qualifier code 06 when no specific variation is requested
Binary Input Change Event Object	Without Time With Time	With Time	The default BI change event object variation for requests with qualifier code 06 when no specific variation is requested
<b>Analog Inputs (AI)</b>			
Number of AI to Generate events	0-64 <sup>3</sup>	43	The total number of AI change event points for monitoring

Parameter	Options	Default	Description
Analog Input Object	32-bit 32-bit –Flag 16-bit 16-bit –Flag	16-bit -Flag	The default AI object variation for requests with qualifier code 06 when no specific variation is requested
Analog Input Change Event Object	32-bit -Time 32-bit +Time 16-bit -Time 16-bit +Time	16-bit +Time	The default AI change event object variation for requests with qualifier code 06 when no specific variation is requested
<b>Binary Counters (BC)</b>			
Number of BC to Generate events	0-64 <sup>3</sup>	0	The total number of BC change event points for monitoring
Binary Counter Object	32-bit +Flag 32-bit –Flag 16-bit +Flag 16-bit –Flag	32-bit -Flag	The default BC object variation for requests with qualifier code 06 when no specific variation is requested
Binary Counter Change Event Object	32-bit -Time 32-bit +Time 16-bit -Time 16-bit +Time	32-bit +Time	The default BC change event object variation for requests with qualifier code 06 when no specific variation is requested
Frozen Binary Counter Object	32-bit +Flag 32-bit –Flag 32-bit +Time 16-bit +Flag 16-bit –Flag 16-bit +Time	32-bit -Flag	The default frozen BC object variation for requests with qualifier code 06 when no specific variation is requested
<b>DNP General Options</b>			
16-bit AI Scaling	Disabled Enabled	Enabled	Allows scaling 16-bit analog input objects (see description below)
16-bit BC Scaling	x1, x10, x100, x1000	x1	Allows scaling 16-bit binary counter objects (see description below)
Re-mapping Event Points	Disabled Enabled	Disabled	Allows re-mapping event points starting with point 0.
SBO Timeout <sup>1</sup>	2-30 sec	10	Defines the Select Before Operate (SBO) timeout when using the Control-Relay-Output-Block object
Time Sync Period <sup>2</sup>	0-86400 sec	86400	Defines the time interval between periodic time synchronization requests
Multi Fragment Interval	50-500 ms	50	Defines the time interval between fragments of the response message when it is fragmented

<sup>1</sup> The Select Before Operate command causes the device to start a timer. The following Operate command must be sent before the specified timeout value expires.

<sup>2</sup> The device requests time synchronization by bit 4 in the first octet of the internal indication word being set to 1 when the time interval specified by the Time Sync Period elapses. The master should synchronize the time in the device by sending the Time and Date object to clear this bit. The device does not send time synchronization requests if the Time Sync Period is set to 0.

<sup>3</sup> The total number of AI, BI and BC change event points may not exceed 64. When you change the number of the change event points in the device, all event setpoints are set to defaults (see Configuring DNP Event Classes below).

### Scaling 16-bit AI objects

Scaling 16-bit AI objects allows accommodating native 32-bit analog input readings to 16-bit object format; otherwise it may cause an over-range error if the full-range value exceeds a 16-bit point limit.

Scaling is enabled by default. It is not applied to points that are read using 32-bit AI objects.

Refer to the EM720 DNP3 Reference Guide for information on the data point scales and on a reverse conversion that should be applied to the received scaled values.

### Scaling 16-bit Binary Counters

Scaling 16-bit Binary Counters allows changing a counter unit in powers of 10 to accommodate a 32-bit counter value to 16-bit BC object format.

If the scaling unit is greater than 1, the counter value is reported being divided by the selected scaling unit from 10 to 1000. To get the actual value, multiply the counter reading by the scaling unit.

## Configuring DNP Class 0 Response

The most common method of getting static object information from the device via DNP is to issue a read Class 0 request. The EM720 allows you to configure the Class 0 response by assigning ranges of points to be polled via Class 0 requests.

To view the factory-set DNP Class 0 assignments or build your own Class 0 response message:

1. From the Meter Setup menu select Protocol Setup and click on the DNP Class 0 Points tab
2. Select the object and variation type for a point range.
3. Specify the start point index and the number of points in the range. Refer to the EM720 DNP3 Reference Guide for available data points.
4. Repeat these steps for all point ranges you want to be included into the Class 0 response.
5. Click Send to download your setup to the device.

The factory-set Class 0 point ranges are shown in the picture below.

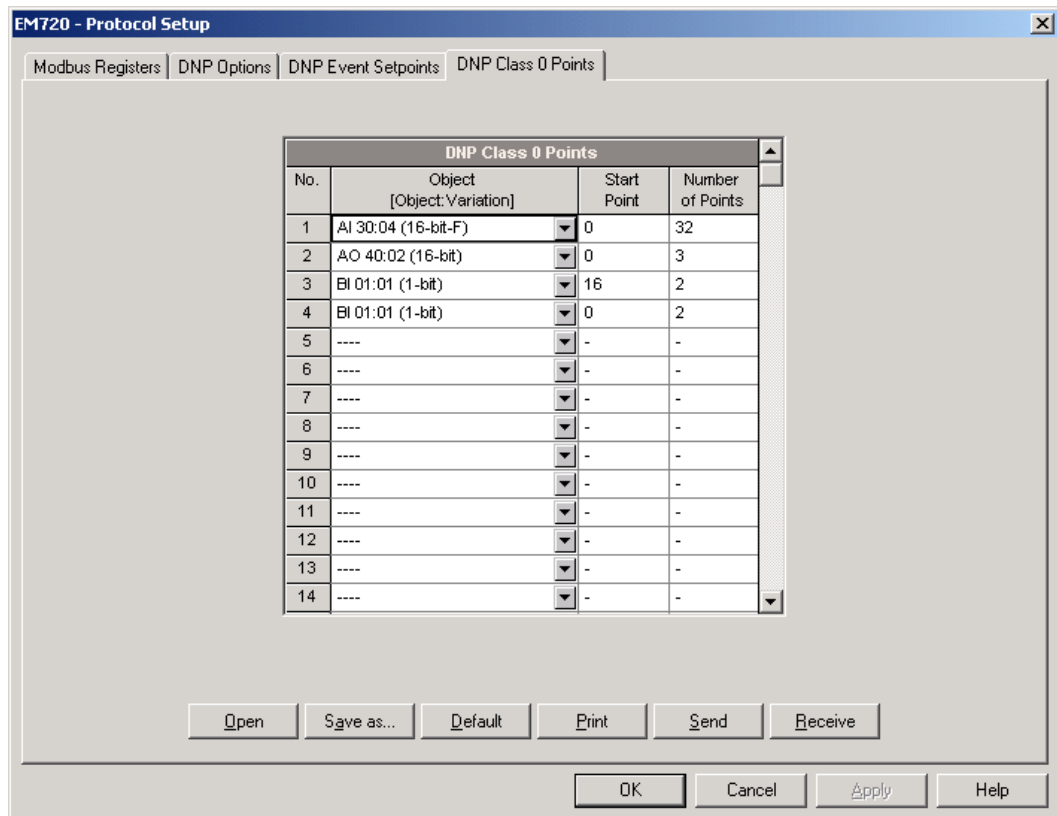

### Configuring DNP Event Classes

The EM720 generates object change events for any static analog input, binary input, and binary counter point when a corresponding point either exceeds a predefined threshold, or the point status changes. A total of 64 change event points are available for monitoring.

Object change events are normally polled via DNP Class 1, Class 2 or Class 3 requests. You can link any change event point to any event class upon the event priority. Refer to the EM720 DNP3 Reference Guide for more information on polling event classes via DNP.

A change event point index is normally the same as for the corresponding static object point. To use independent numeration for event points, enable re-mapping event point indices via DNP Options setup (see above) so they start with index 0.

Define a separate event setpoint for each static object point to be monitored for change events. To view or change the factory-set DNP event setpoints, select Protocol Setup from the Meter Setup menu and click on the DNP Event Setpoints tab.

No.	Event Point	Static Point	Ext	Group	Parameter	Relation	Threshold/Deadband	Ev On	Log On	Ev Class
1	AI:0	AI:0	<input type="checkbox"/>	AVR PHASE	V1	<	14000.0	<input checked="" type="checkbox"/>	<input type="checkbox"/>	#1
2	AI:1	AI:1	<input type="checkbox"/>	AVR PHASE	V2	<	14000.0	<input checked="" type="checkbox"/>	<input type="checkbox"/>	#1
3	AI:2	AI:2	<input type="checkbox"/>	AVR PHASE	V3	<	14000.0	<input checked="" type="checkbox"/>	<input type="checkbox"/>	#1
4	AI:3	AI:3	<input type="checkbox"/>	AVR PHASE	I1	>	1200.00	<input checked="" type="checkbox"/>	<input type="checkbox"/>	#1
5	AI:4	AI:4	<input type="checkbox"/>	AVR PHASE	I2	>	1200.00	<input checked="" type="checkbox"/>	<input type="checkbox"/>	#1
6	AI:5	AI:5	<input type="checkbox"/>	AVR PHASE	I3	>	1200.00	<input checked="" type="checkbox"/>	<input type="checkbox"/>	#1
7	AI:39170	AI:39170	<input checked="" type="checkbox"/>	%HD V1/V12	V1 %HD03	>	3.00	<input checked="" type="checkbox"/>	<input type="checkbox"/>	#2
8	AI:39426	AI:39426	<input checked="" type="checkbox"/>	%HD V2/V23	V2 %HD03	>	3.00	<input checked="" type="checkbox"/>	<input type="checkbox"/>	#2
9	AI:39682	AI:39682	<input checked="" type="checkbox"/>	%HD V3/V31	V3 %HD03	>	3.00	<input checked="" type="checkbox"/>	<input type="checkbox"/>	#2
10	AI:9	AI:9	<input type="checkbox"/>	AVR PHASE	kvar L1	Delta	0.000	<input type="checkbox"/>	<input type="checkbox"/>	#1
11	AI:10	AI:10	<input type="checkbox"/>	AVR PHASE	kvar L2	Delta	0.000	<input type="checkbox"/>	<input type="checkbox"/>	#1
12	AI:11	AI:11	<input type="checkbox"/>	AVR PHASE	kvar L3	Delta	0.000	<input type="checkbox"/>	<input type="checkbox"/>	#1
13	AI:12	AI:12	<input type="checkbox"/>	AVR PHASE	kVA L1	Delta	0.000	<input type="checkbox"/>	<input type="checkbox"/>	#1
14	AI:13	AI:13	<input type="checkbox"/>	AVR PHASE	kVA L2	Delta	0.000	<input type="checkbox"/>	<input type="checkbox"/>	#1
15	AI:14	AI:14	<input type="checkbox"/>	AVR PHASE	kVA L3	Delta	0.000	<input type="checkbox"/>	<input type="checkbox"/>	#1

The number of event setpoints for each static object type is specified via the [DNP Options](#) setup.

#### NOTE

The device clears all event buffers and links the default set of static points to each event object type every time you change the number of points for any of the objects.

#### To define setpoints for selected static points:

1. Check the “Ext” box if you wish to use the extended point list.
2. Select a parameter group and then a desired parameter for each event point.
3. For AI and BC points, select a relation and an operating threshold or a deadband to be used for detecting events. All thresholds are specified in primary units. The following relations are available:
  - Delta – a new event is generated when the absolute value of the difference between the last reported point value and its current value exceeds the specified deadband value;
  - More than (over) - a new event is generated when the point value rises over the specified threshold, and then when it returns below the threshold minus a predefined return hysteresis – applicable for AI objects;
  - Less than (under) - a new event is generated when the point value drops below the specified threshold, and then when it returns above the threshold plus a

predefined return hysteresis – applicable for AI objects.

Hysteresis for the return threshold is 0.05 Hz for frequency and 2% of the operating threshold for all other points.

4. Check the “Ev On” box for the points you wish to be included into event poll reports.
5. In the “Ev Class” box, select the event poll class for the change event points.
6. Repeat these steps for all points you want to be monitored for events.
7. Click Send to download your setup to the device.

## Configuring Meter Passwords



### Using the Front Display

Select Access from the main menu. You should have administration rights to enter this menu. See [Viewing and Changing Setup Options](#) in Chapter 3 for information on navigating in menus.

The setup menu allows you to configure three passwords for three security levels the meter provides.

#### To setup the meter passwords:

1. Use the SCROLL button to scroll through the passwords.
2. Press briefly SELECT/ENTER button to highlight the password window.
3. Enter the new password as you enter numerical values.
4. Press the SELECT/ENTER button for more than 1 second to save your new setting.
5. Setup the remaining passwords and save them to the meter.

### Using PAS

PAS allows you to prepare and save the passwords in the meter site database and then download them at once to your meter or to multiple meters, or you can change any password individually online.

To configure passwords offline or to update them all together, select Administration Setup from the Meter Setup menu.

The present passwords settings are never uploaded from the meter via the Passwords setup. When you open the dialog, all passwords are zeroed.

#### To setup new passwords:

1. Enter the first (lower-level) password in the "Password 1" box and repeat it in the following "Confirm password" box.
2. In the same manner, enter Password 2 and Password 3 for the medium and high-level security passwords.
3. Click "Save as" to save the passwords to the site database. The passwords are stored in an encrypted form.
4. Click "Send" to update passwords in your meter.

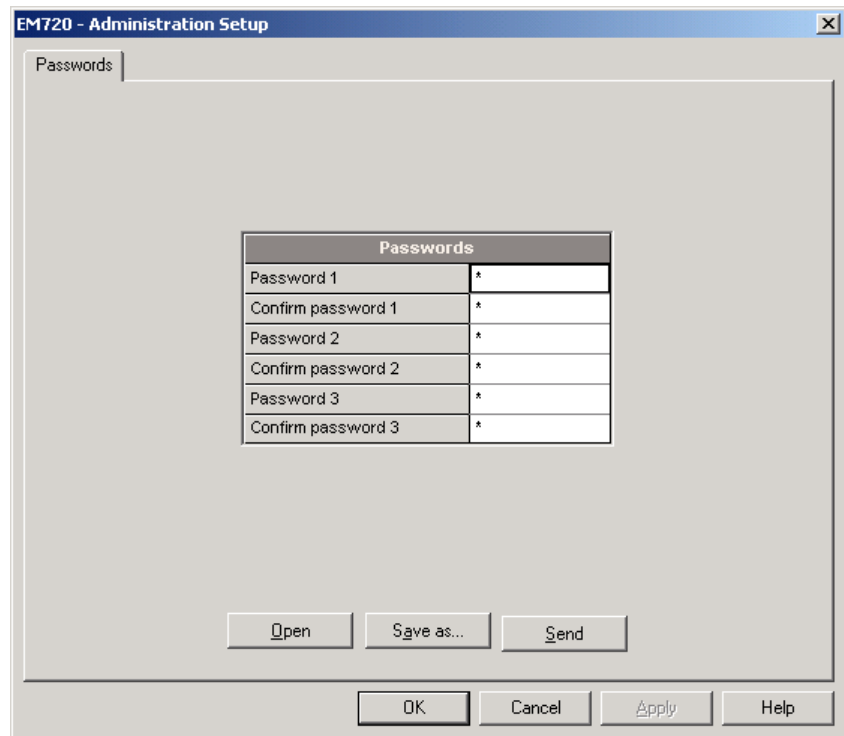
**To setup a password online:**

1. From the Monitor menu, select Administration -> Change Password, and then click on the password you wish to change.



2. Enter the new password and repeat it in the following "Confirm new password" box.
3. Click Send to update the password in the meter.



## Chapter 6 Device Control and Upgrading

This chapter describes how to perform control functions in your meter from the front panel display and via PAS.

To access device control options from PAS, you should have your meter online and provide a correct password with respective permissions.

### Updating the Meter Clock

```
RTC      Nov 28, 2008
Time     18:01:18
```

SELECT  SHORT PRESS

```
RTC      Nov 28, 2008
Time     18:02:47
```

SCROLL 

```
RTC      Nov 28, 2008
Time     18:03:47
```

ENTER  LONG PRESS

```
RTC      Nov 28, 2008
Time     18:03:49
```

#### Using the Front Display

To enter the clock setup menu, select RTC from the main menu. See [Viewing and Changing Setup Options](#) in Chapter 3 for information on navigating in menus.

#### To setup the clock:

1. Highlight a time or date item you wish to change by pressing briefly the SELECT/ENTER button.
2. Adjust the selected item with the SCROLL button.
3. Highlight the next item you wish to change and adjust it in the same manner.
4. To store your new clock setting, press the SELECT/ENTER button for more than 1 second. If you confirm the clock change from the highlighted "seconds" window, the seconds are zeroed.
5. To exit menu, press the SELECT/ENTER button for more than 1 second when the "Time" item is highlighted.

#### Using PAS

#### To update the clock in your meter:

1. Select a device site from the list box on the toolbar and check the On-line button.
2. Select RTC from the Monitor menu. The RTC dialog displays the current PC time and the time in your device.

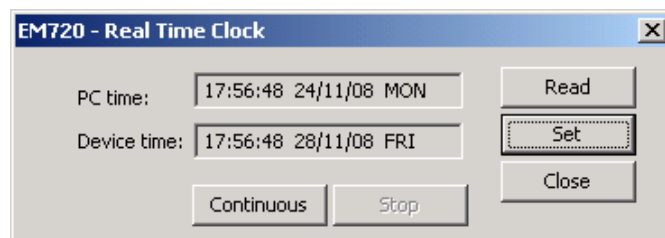

3. To synchronize the meter clock with the PC clock, click Set.

You need not update the clock in your meter if the clock is synchronized to the external GPS master clock.

## Clearing Device Diagnostics

### Using the Front Display

See the following section [Resetting Accumulators and Log Files](#) on how to clear the device diagnostics from the front display.

### Using PAS

Via PAS, you can both examine the present device diagnostics status, and clear it.

To enter the Device Diagnostics dialog, select Device Control from the Monitor menu, and then click on the Device Diagnostics tab.

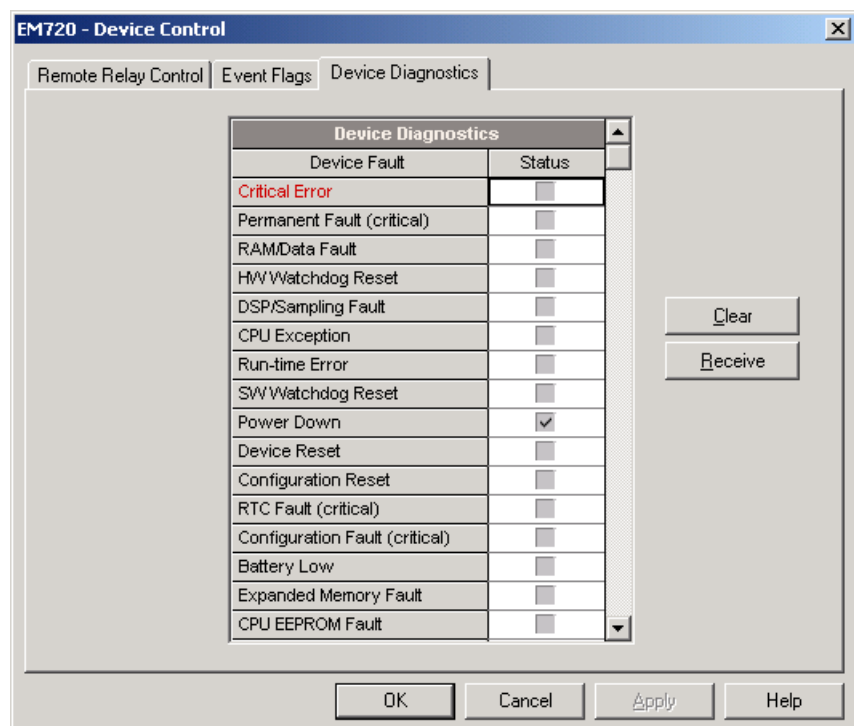

To clear the device diagnostics events, click on Clear.

Refer to [Device Diagnostic Codes](#) in Appendix G for the list of diagnostic codes and their meanings.

You can also clear the device diagnostics via the Clear Operation/Event Counters entry in the Reset dialog (see the following section).

## Resetting Accumulators and Log Files

### Using the Front Display

Select Reset from the main menu. See [Viewing and Changing Setup Options](#) in Chapter 3 for information on navigating in menus.

Access to the RESET menu entries is allowed depending on your security level as shown in the following table. Clearing files is not allowed from the front display.

Reset Entry	Menu Function	Security Level
Diagnostics	Reset of device diagnostics	Low
Bill/TOU MD	Reset of billing maximum demands and triggering an end of billing period	Low
Power MD Volt/Amp MD Volt MD Ampere MD Harmonic MD All MD	Reset of engineering maximum demands	Low
Dev. Oper. Time	Reset of the meter operation time counters	Medium
Lith. Bat. Time	Reset of the lithium battery operation time counters	Medium
Aux. Bat. Time	Reset of the rechargeable auxiliary battery operation time counters	Medium
Power Failures	Reset of the meter failure counters	Medium

#### To reset a desired entry:

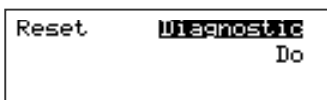

SCROLL 



SELECT  SHORT PRESS

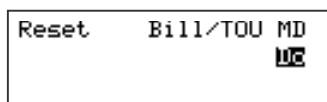

ENTER  EXTENDED PRESS



1. Use the SCROLL button to scroll through the menu entries until a required reset entry appears in the window.
2. Press briefly SELECT/ENTER button to highlight the "Do" entry.
3. Press and hold the SELECT/ENTER button for more than 5 seconds until the "Do" entry is replaced with "Done" indicating that the operation is complete.
4. Release the button.

If your security level does not allow access to a menu entry, you will not be able to highlight the lower action window.

#### NOTE

You may not be allowed to reset the billing maximum demands in the event this action is not enabled for the front display in the Device Options setup, or it has been just performed once at the same day – the meter does not allow repeated triggering an end of billing period within one calendar day.

#### Using PAS

Select Reset from the Monitor menu.

Refer to the table above for required permissions. To clear log files, you should have the administration rights.

#### NOTE

The "Clear All Log Files" entry does not affect billing data and energy load profile files.

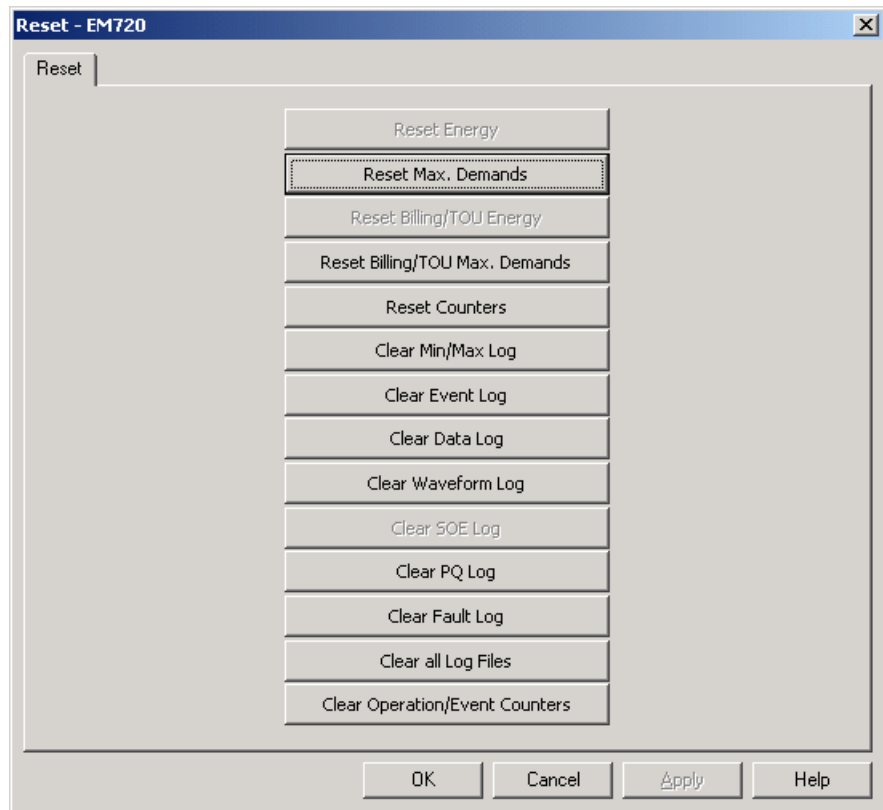

**To reset the accumulation counters or to clear a file:**

1. Click on the corresponding button.

If a reset entry has more than one target, you are allowed to select targets from the dialog box.

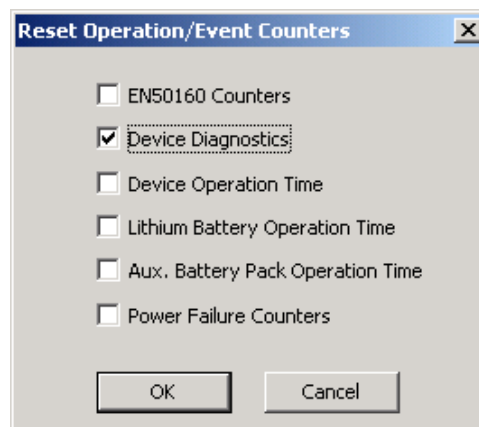

2. Check the corresponding boxes, and then click OK.
3. Confirm your command to send it to the meter.

## Remote Relay Control

From PAS, you can send a command to any relay in your meter or to release a latched relay, except of the relays that are linked to the internal pulse sources. Such relays cannot be operated outside of the device.

To enter the dialog box, select Device Control from the Monitor menu, and then click on the Remote Relay Control tab.

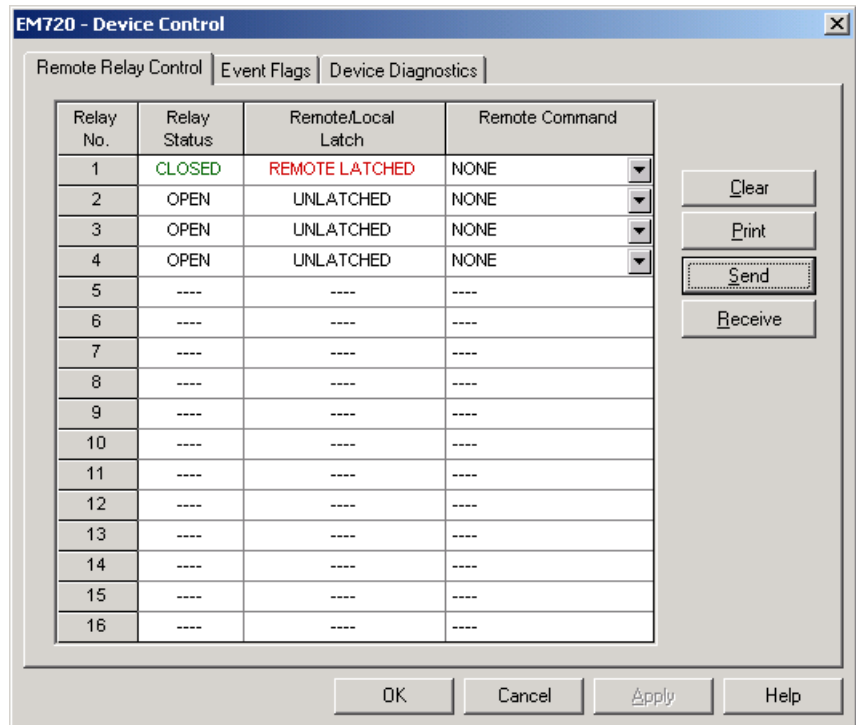

#### To send a remote command to the relay:

1. From the "Relay Command" box for the relay, select the desired command.
2. Click on Send.

The dialog shows you the present relay status and whether it is latched by a remote command or locally from the setpoint.

## Operating Event Flags

The EM720 has 8 common event flags that are intended for use as temporary event storage and can be tested and operated from the control setpoints. You can transfer an event to the setpoint and trigger its operation remotely by changing the event status through PAS.

To enter the Event Flags dialog, select Device Control from the Monitor menu, and then click on the Event Flags tab.

#### To change the status of an event flag:

1. In the "Status" box, select the desired flag status.
2. Click on Send.

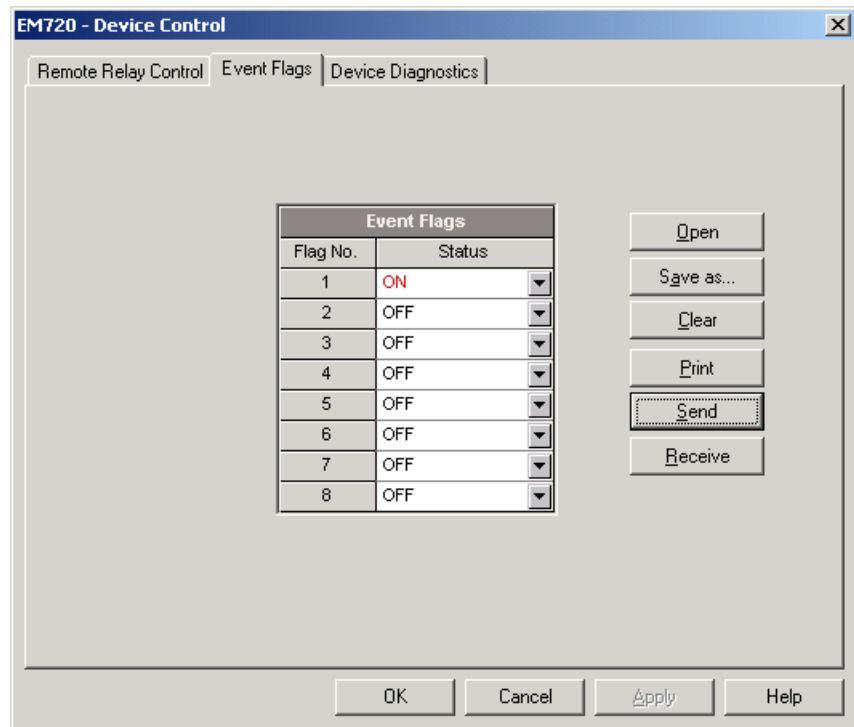

## Upgrading Meter Firmware

You can upgrade device firmware through any communication port installed in your meter: a serial port, USB, wireless GSM/GPRS modem, or via the Internet.

Downloading firmware is only supported through the Modbus RTU/ASCII and Modbus/TCP protocols. If you are connected to the meter via a serial port, ensure that it operates in Modbus mode. It is also recommended to set the serial port baud rate to 115,200 bps. See [Configuring Communications](#) on how to remotely change the protocol and baud rate in your meter.

To download a firmware file to your meter:

1. Check the On-line button on the PAS toolbar, select Flash Downloader from the Monitor menu, and then confirm changes.

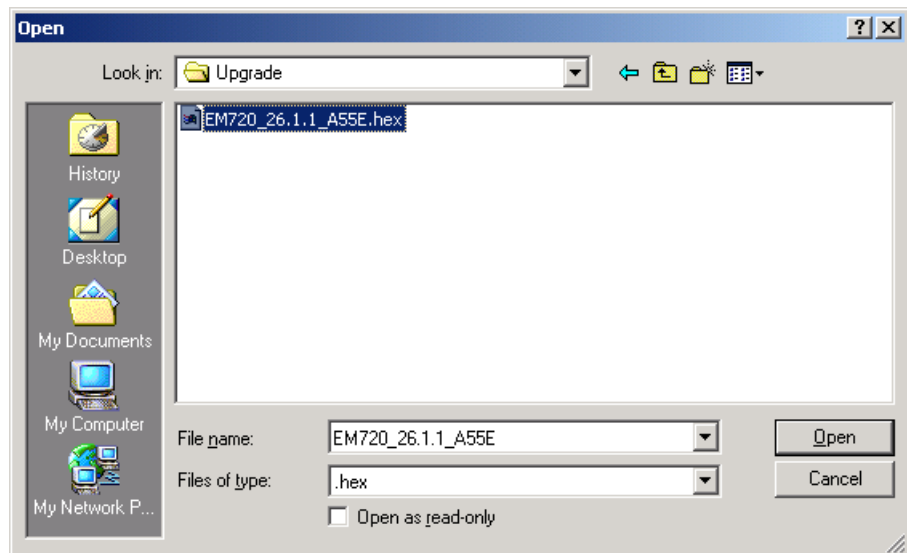

2. Point to the firmware upgrade file, click Open, and then confirm upgrading the meter.
3. When asked for the password, type the meter password, and click OK.

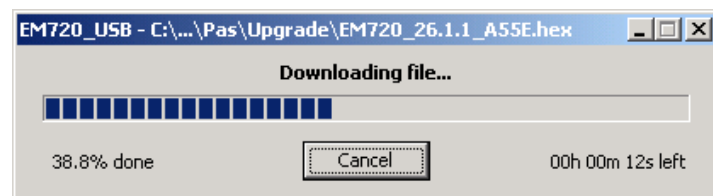

4. Wait until PAS completes downloading the file. It takes about 9-10 minutes at 115,200 bps via a serial port, or about 20 seconds via a USB port, to download the file to the meter.

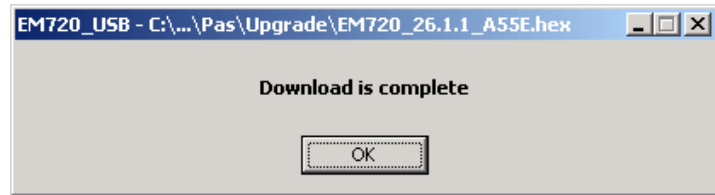

5. Wait about 10 seconds until the meter completes burning firmware into the flash and reboots before any further manipulating with the meter.

#### NOTES

1. When the meter reboots, the Ethernet and GPRS networks are both restart, so communications may be temporarily lost. You may need to wait a short duration before PAS restores a connection with your meter.
2. If you are connected to the meter via a wireless GPRS network, the meter will logout of the network and logon again so the IP address you used for connecting to the meter will no longer be supported. You should check the meter for a new GPRS network IP address either from the front display, or via PAS using another communication port.



## Chapter 7 Monitoring Meters

### Viewing Real-time Data

Real-time data is continuously retrieved from your devices and updated on the screen at the rate you defined in the Instrument Setup.

To get real-time data from your device:

1. Ensure that the On-line button on the PAS toolbar is checked.
2. Select the device site from the list box on the PAS toolbar.
3. Point to RT Data Monitor on the Monitor menu, and then select a data set you want to view.

### Organizing Data Sets

PAS supports 33 programmable data sets with up to 40 data parameters. Set #0 is intended for simple meters, which have a limited number of parameters, and is not recommended for the use with the EM720. To re-organize data sets, select RT Data Sets from the Monitor menu or click on the button  on the local toolbar.

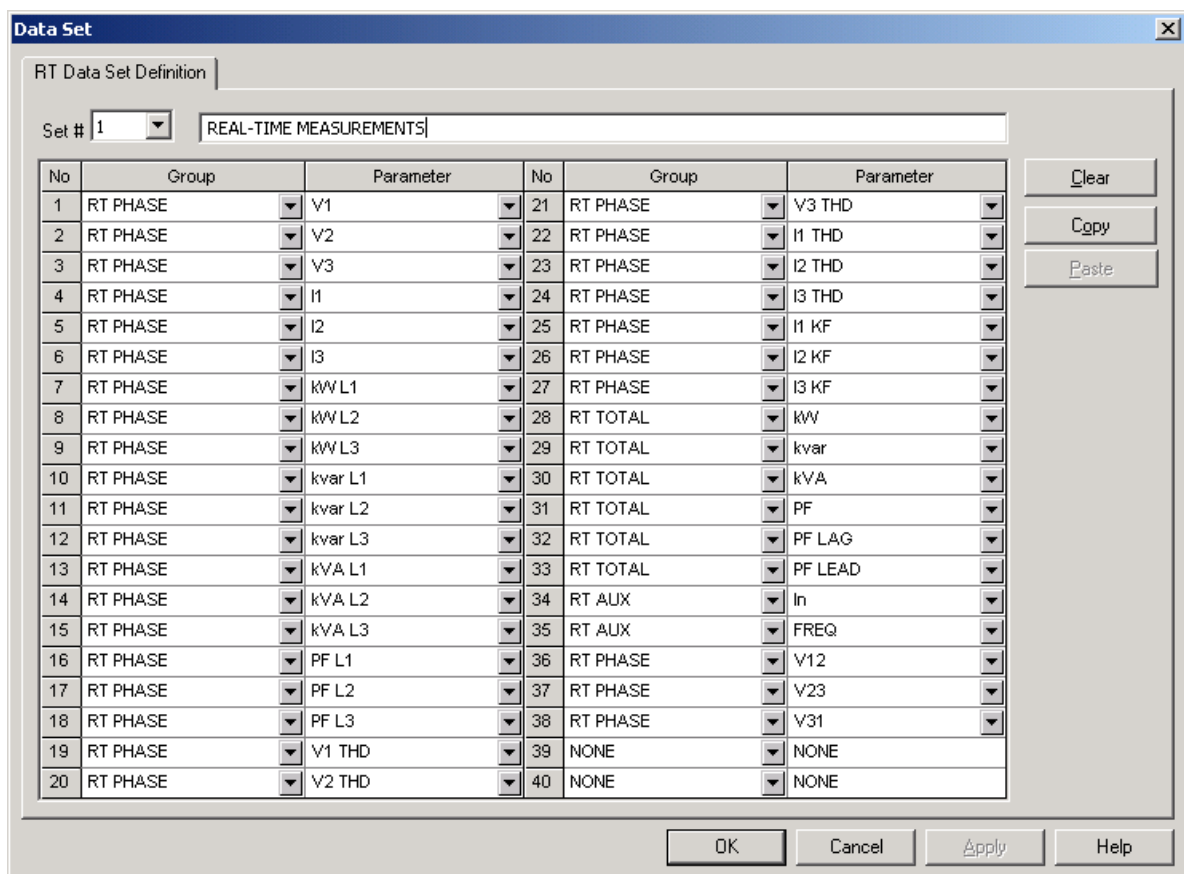

RT Data Set Definition



Set # 1 REAL-TIME MEASUREMENTS

No	Group	Parameter	No	Group	Parameter
1	RT PHASE	V1	21	RT PHASE	V3 THD
2	RT PHASE	V2	22	RT PHASE	I1 THD
3	RT PHASE	V3	23	RT PHASE	I2 THD
4	RT PHASE	I1	24	RT PHASE	I3 THD
5	RT PHASE	I2	25	RT PHASE	I1 KF
6	RT PHASE	I3	26	RT PHASE	I2 KF
7	RT PHASE	kW L1	27	RT PHASE	I3 KF
8	RT PHASE	kW L2	28	RT TOTAL	kW
9	RT PHASE	kW L3	29	RT TOTAL	kvar
10	RT PHASE	kvar L1	30	RT TOTAL	kVA
11	RT PHASE	kvar L2	31	RT TOTAL	PF
12	RT PHASE	kvar L3	32	RT TOTAL	PF LAG
13	RT PHASE	kVA L1	33	RT TOTAL	PF LEAD
14	RT PHASE	kVA L2	34	RT AUX	In
15	RT PHASE	kVA L3	35	RT AUX	FREQ
16	RT PHASE	PF L1	36	RT PHASE	V12
17	RT PHASE	PF L2	37	RT PHASE	V23
18	RT PHASE	PF L3	38	RT PHASE	V31
19	RT PHASE	V1 THD	39	NONE	NONE
20	RT PHASE	V2 THD	40	NONE	NONE

Buttons: Clear, Copy, Paste, OK, Cancel, Apply, Help

Some data sets are preset for your convenience and others are empty. You can freely modify data sets.

### Polling Devices

To run data polling, click on either the Poll button  or Continuous Poll button  on the local toolbar. Click on the Stop button  to stop continuous polling.

You can open as many monitor windows as you wish, either for different sites, or for the same site using different data sets. An open data monitor window is linked to the current site and does not change if you select another site in the site list.

You can view acquired data in a tabular form or in a graphical form as a data trend.

The following picture shows a typical data monitor window.

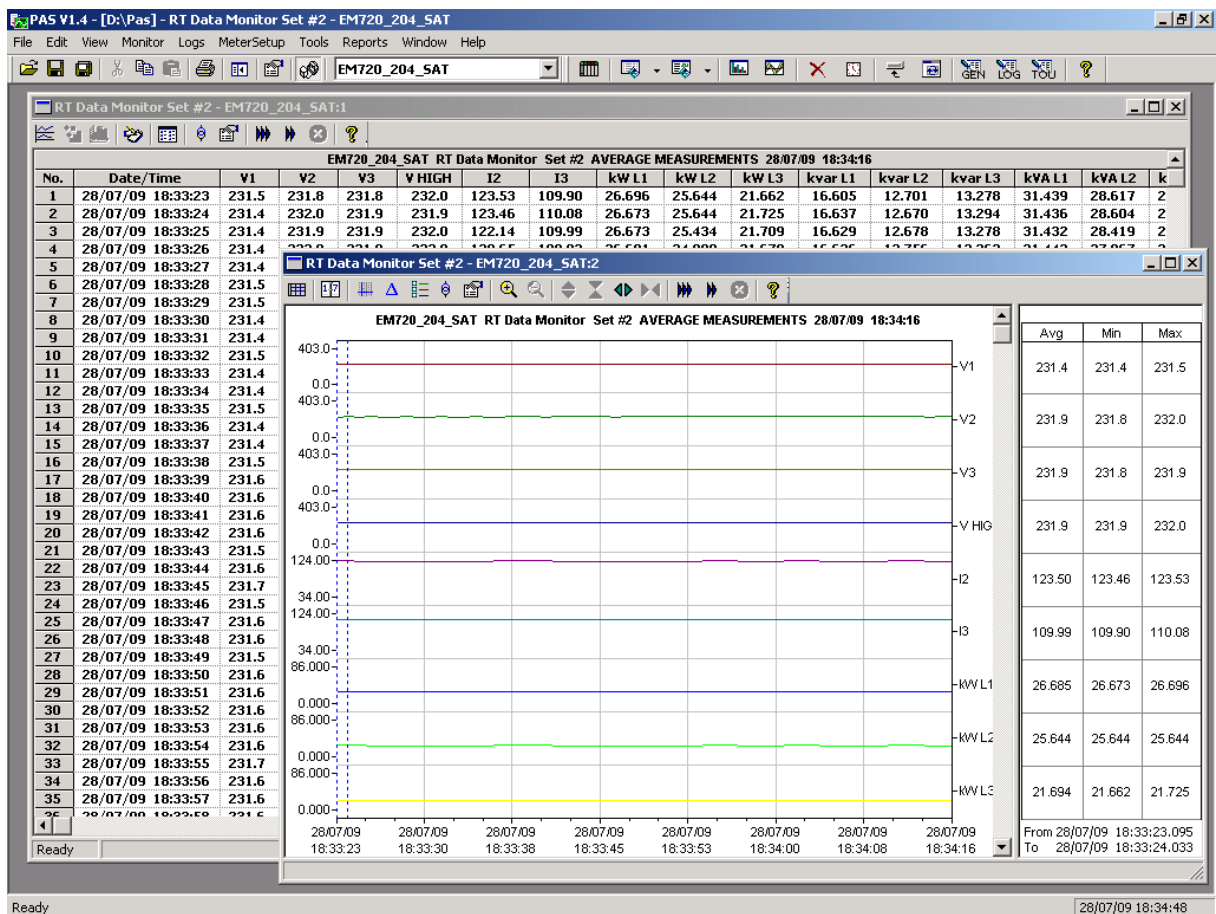

### Polling Options

To change the polling options, click on the Data Monitor window with the right mouse button and select Options.

If you check "Do not stop on errors", polling is resumed automatically when a communication error occurs, otherwise polling stops until you restart it manually.

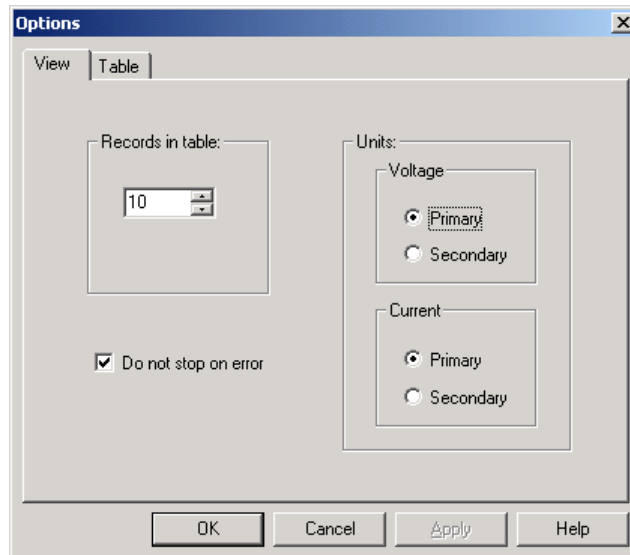

## Viewing a Data Table

### Changing the Data View

PAS displays data in either a single record or multi-record view. To change the view, click on the Data Monitor window with the right mouse button and select either Wrap to see a single record, or UnWrap to go to the multi-record view.

### Adjusting the Number of Rows in a Multi-Record View

Click the window with the right mouse button, select Options, adjust the number of records you want to see in the window, and then click OK. When the number of retrieved records exceeds the number of rows in the window, the window scrolls up so that older records are erased.

See [Working with Tables](#) in Chapter 9 for more information on working with tables.

## Viewing Data Trend

To view a data trend, click on the  button on the local toolbar.

To change the time range for your graph, click on the  button on the local toolbar, and then select the desired date and time range.

See [Working with Graphic Windows](#) in Chapter 9 for more information on working with graphs.

## Saving Data to a File

To save retrieved data to a file for later analysis, click on the Save button , select an existing database or type the name for a new database, and then click Save.

To avoid confusion, do not store data files into the "Sites" directory where site databases are located.

## Printing Data

To check the report, as it will look when printed, select Print Preview from the File menu.

To print retrieved data, click on the  button on the PAS toolbar, select a printer, and then click OK.

## Real-time Data Logging

PAS allows you to store data records to a database automatically at the time it updates data on the screen.

### To setup the real-time logging options:



1. Open the Data Monitor window.
2. Click on the "RT Logging On/Off"  button on the local toolbar, or select "RT Logging Options" from the Monitor menu.
3. Select a database, or type the name for a new database and select a directory where you want to save it.
4. Select the number of tables, and the number of records in each table you want recorded.
5. Adjust the file update rate for automatic recording. It must be a multiple of the sampling rate that you defined in the Instrument Setup dialog.
6. Click Save.

When you run real-time data polling, PAS automatically saves retrieved records to a database at the rate you specified.

The "RT Logging On/Off" button  on the toolbar should be checked all the time. You can suspend logging by unchecking the button, and then resume logging by checking it again.

## Viewing Real-time Min/Max Log

To retrieve the real-time Min/Max log data from your meter:

1. Select the device site from the list box on the PAS toolbar.
2. Point to RT Min/Max Log on the Monitor menu, and then select a data set you want to view.
3. Ensure that the On-line button  on the PAS toolbar is checked.
4. Click on the Poll button .



PAS supports 9 programmable data sets that you can organize as you wish. To build your data sets, select MinMax Data Sets from the Monitor menu or click on the  button on the local toolbar.

See [Working with Tables](#) in Chapter 9 for more information on working with tables.

## Viewing Real-time Harmonic Spectrum

To retrieve real-time harmonic spectrum from your meter:

1. Check the On-line button  on the PAS toolbar.
2. Select the device site from the list box on the toolbar.
3. Select RT Harmonic Monitor from the Monitor menu.

Use the Poll button  for a single-step poll or the Continuous poll  button for continuous polling. To stop continuous polling, click on the Stop button .

### Viewing Synthesized Waveforms



To view synthesized waveforms of voltages and currents, click on the  button on the local toolbar.

See [Viewing Waveforms](#) in Chapter 9 for information on using different spectrum views.

## Viewing Real-time Waveforms

To retrieve real-time waveforms from your meter:

1. Check the On-line button  on the PAS toolbar.
2. Select the device site from the list box on the toolbar.
3. Select RT Waveform Monitor from the Monitor menu.

Use the Poll button  for a single-step poll or the Continuous poll  button for continuous polling. To stop continuous polling, click on the Stop button .

PAS normally retrieves seven 4-cycle AC waveforms (V1-V3 and I1-I4) sampled at a rate of 128 samples per cycle. If you wish to get only selected phases, select "Options" from the Tools menu, click on the Preferences tab, check the phases you want polled, and then click OK.

Retrieved waveforms can be displayed in different views as overlapped or non-overlapped waveforms, as an RMS cycle-by-cycle plot, or as a harmonic spectrum chart or a table.

See [Viewing Waveforms](#) in Chapter 9 for information on using different waveform views.

## Chapter 8 Retrieving and Storing Files

Using PAS, you can retrieve recorded events, data and waveforms from your devices and save them to files on your PC in the Microsoft Access database format.

Historical data can be uploaded on demand any time you need it, or periodically through the Upload Scheduler that retrieves data automatically on a predefined schedule, for example, daily, weekly or monthly.

If you do not change the destination database location, new data is added to the same database so you can store long-term data profiles in one database regardless of the upload schedule you selected.

### Uploading Files on Demand

**To retrieve the log files from your device:**

1. Select a device site from the list box on the PAS toolbar.
2. Check the On-line button .
3. Select Upload Logs from the Logs menu.

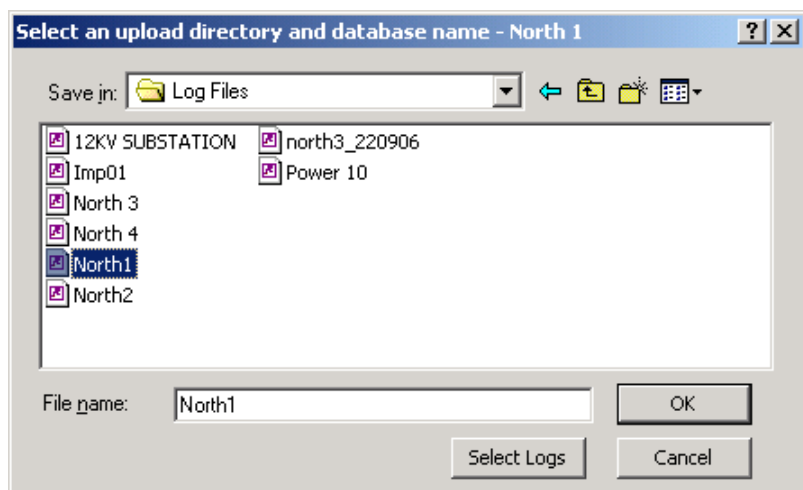

4. Select a database, or type the name for a new database, and select a directory where you want to save it.
5. Click on the "Select Logs" button and check boxes for logs you want to be retrieved from the device.

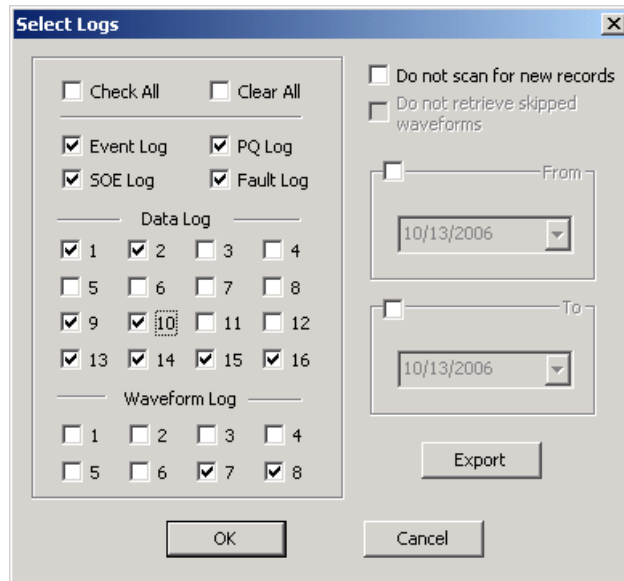

6. If you wish to retrieve data starting with a known date, check the “From” box and select the start date for retrieving data.
7. If you wish to retrieve data recorded before a known date, check the “To” box and select the last date for retrieving data.
8. Click OK.

## Using the Upload Scheduler

### To setup the Upload Scheduler:

1. Select Upload Scheduler from the Logs menu.

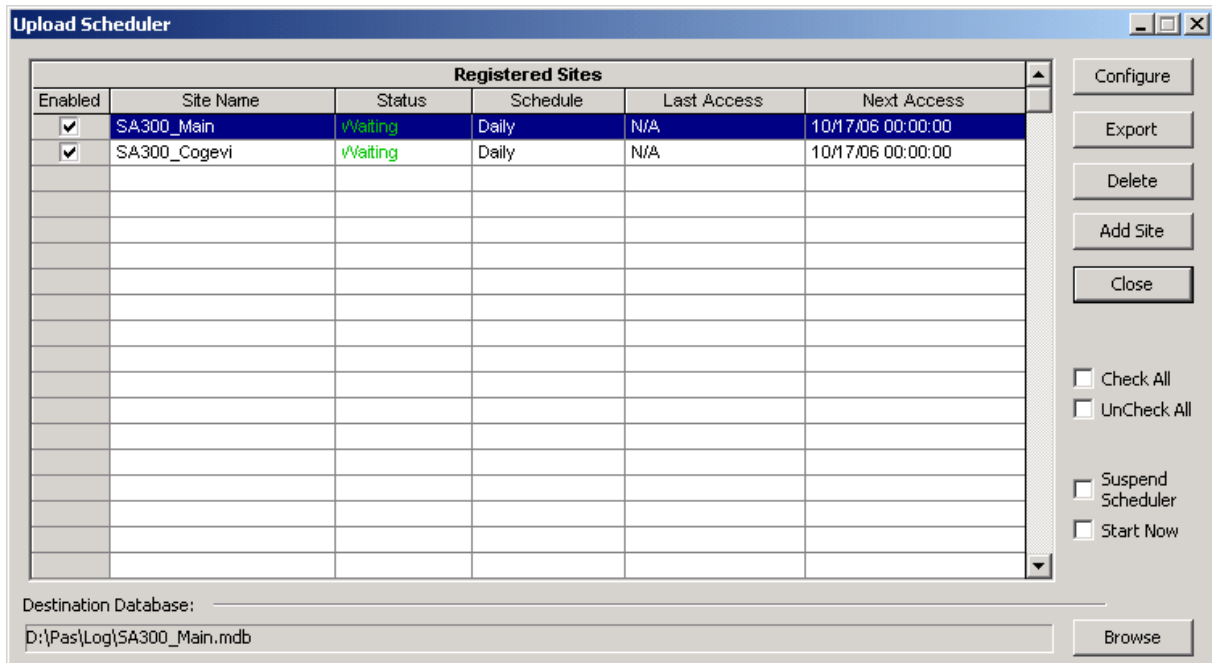

2. Click Add Site, point to the site database for which you want to organize the schedule, and then click OK.

3. Click Browse and select a database for storing retrieved data, or type the name for a new database, select a directory where you want to save it, and then click OK.
4. Click Configure or double click on the site row.

5. Select a daily, weekly or monthly schedule, and adjust the start time. If you wish to upload data periodically in predefined intervals, click on "Periodic" and define the time period in hours and minutes.
6. Select the number of attempts to upload data in the event of temporary communication problems or unavailability of your device, and the delay between attempts in minutes and seconds.
7. If you wish to use the schedule to synchronize the device clock with your PC, check the "RTC Synchronization Enable" box. If your device is password protected by a communications password, type in the password you set in the device to allow PAS to update the clock.
8. Click on the Select Logs button, check the boxes for logs you want to upload on a schedule, and then click OK.
9. Check the Enabled box at left to activate a schedule for the device.
10. Click Close to store your schedule.

To keep the Upload Scheduler running, the On-line button  on the PAS toolbar must be checked all the time. If you uncheck it, the scheduler stops operations. This does not cause loss of data, since the scheduler will resume operations when you check this button again.



### **Suspending the Scheduler**

To suspend the Upload Scheduler, check the Suspend Scheduler box at right. To activate the Upload Scheduler, leave this box unchecked.

### **Running the Scheduler on Demand**

You can run the scheduler at any time outside the schedule by checking the Start Now box at right. This is a one-time action. After uploading is completed, the Upload Scheduler un-checks this box automatically.

### **Reviewing Upload Problems**

When the Upload Scheduler fails to retrieve data from the device, or some data is missing, or another problem occurs, it puts an error message to the log file. To review this file, select System Log from the View menu.

## **Retrieving EN50160 Statistics Files**

The EN50160 statistics files and present contents of the EN50160 evaluation counters can be retrieved by PAS and stored to a database for later analysis.

### **Using the Upload Scheduler**

The PAS Upload Scheduler automatically retrieves the EN50160 statistics files on a daily or weekly basis depending on the EN50160 evaluation period selected in your device.

Select the Daily or Weekly schedule for the EN50160 statistics files when configuring the upload schedule (see [Using the Upload Scheduler](#)). Check the Data log #9 and #10 boxes in the Select Logs dialog box for uploading the EN50160 Compliance Statistics and EN50160 Harmonics Survey files respectively.

### **Retrieving EN50160 Statistics Files on Demand**

To manually retrieve the EN50160 statistics files on demand, select "Upload EN50160 Compliance Stats" from the Logs menu and specify the database to which you want the data to be stored.





### **Retrieving the EN50160 Online Statistics**

To retrieve the present contents of the EN50160 statistics counters accumulated since the beginning of the current evaluation period, select "Upload EN50160 Online Stats" from the Logs menu and specify the database to which you want the data to be stored. The statistics records are marked as online events.

See [Viewing EN50160 Statistics Reports](#) on how to get the EN50160 compliance report for the latest online statistics stored in the database.

## Viewing Files On-line

Sometimes, it is useful to review a particular piece of historical data on-line at the time you expect new events to appear in the log. PAS allows you to retrieve historical data from a particular log without storing it to a file. The data appears only in the window on your screen. You can save it manually to the database.

To view the log data on-line, check the On-line button  on the PAS toolbar, select the log you want to retrieve in the Logs menu, and then click on the Poll button . Only new log records are retrieved from the device. If you want to review the entire log from the beginning, click on the Restore log button , and then click on the Poll button .

### NOTES

1. When reading multi-section profile data and PQ statistics files, only a first section is available for reading online.
2. There is a difference between reading waveforms on-line and viewing waveform files. Online waveforms are read one record a time, so a multi-record waveform series may not be viewed as a single waveform.

See Chapter 9 [Viewing Log Files and Reports](#) for information on using different log views.

## Retrieving Waveforms On-line on Events

Looking after a specific event in a waveform file may take much time, especially with low-speed serial communications.

If you find an event in the event log, PQ log or Fault log file for which a waveform has not been yet retrieved, you can instruct PAS to read it for you and store in the meter database without the need to read the entire file.

See Reading and Storing Waveforms On-line in Chapter 9 on how to get a waveform from the meter for a specific event.

## Exporting Files

### Exporting Files in COMTRADE and PQDIF Formats

The COMTRADE and PQDIF file converters allow you to convert waveforms into COMTRADE or PQDIF file format, and data log tables – into PQDIF format.

#### Manual Converting

To manually convert your waveforms or a data log into COMTRADE or PQDIF format:

1. Click on the Export  button on the PAS toolbar.

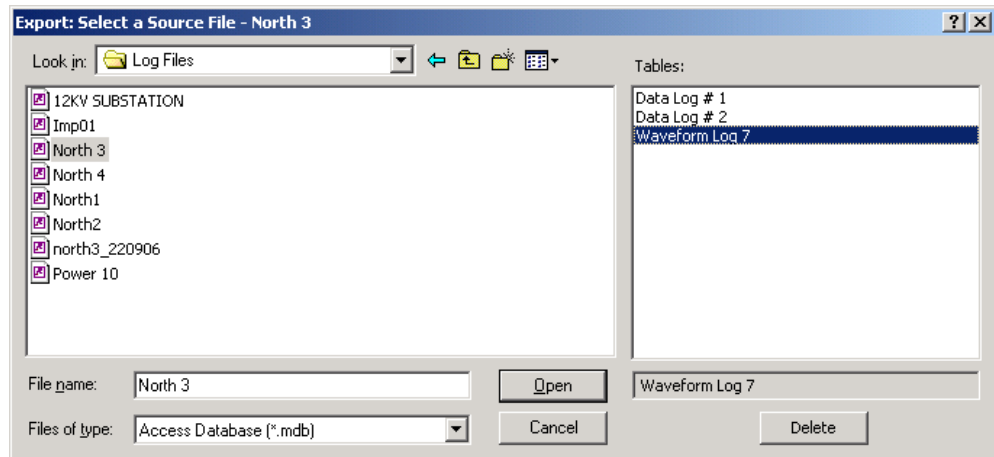

2. Select the database and a waveform or data log table you want to export, and then click Open.

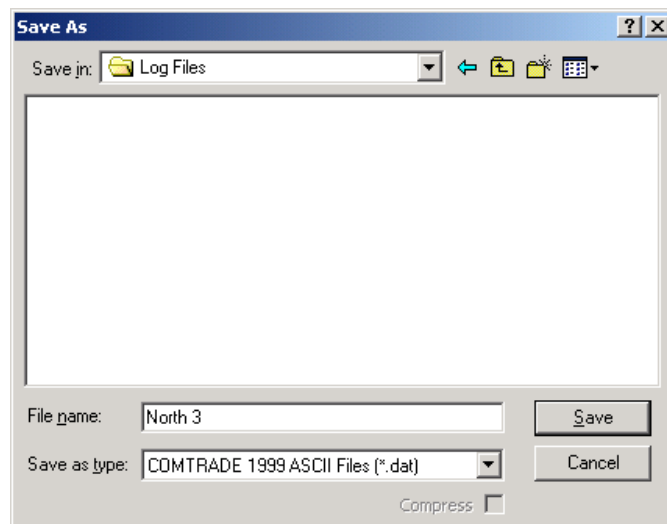

3. Select a directory where you want to store your exported files, type a file name that identifies your files, select a desired file output format, and then click on the Save button. The PQDIF files are commonly recorded in compressed format. If you do not want your files to be compressed, uncheck the Compress box before saving the file.

In COMTRADE format, each waveform event is recorded into a separate file. A COMTRADE waveform file name contains a site name followed by an ID of the fault or power quality event, which triggered the waveform record.

PQDIF file names contain a site name followed by a timestamp of the first event recorded to the file, and may look like 12KVSUB\_20040928T133038.pqd.

### Automatic Converting

PAS allows you to automatically convert waveform and data logs into COMTRADE or PQDIF format at the time you upload data from your devices via the Upload Scheduler.

To automatically convert your waveform or data log tables into COMTRADE or PQDIF format:

1. Open the Upload Scheduler.

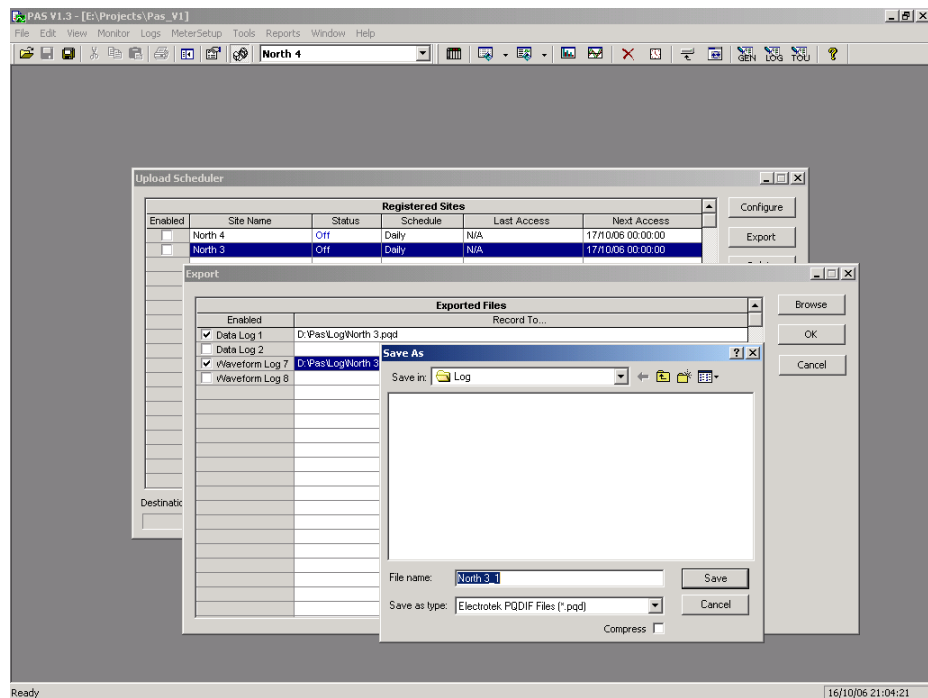

2. Highlight a desired device site with the left mouse button, and then click on the Export button.
3. Check the Enabled box for a data log or a waveform log table you want to automatically convert at the upload time.
4. Highlight the Record to... row for the selected table and click on the Browse button.
5. Select a folder where you want to store converted files, type in the converted file's name, select a desired output file format, and then click on Save.
6. Repeat the same for all tables you wish to be converted.
7. Click OK.

## Exporting Files in Excel Format

PAS can automatically convert data files into the Microsoft Excel workbook format while retrieving data from your meters via the Upload Scheduler.

To store files in Excel format, follow instructions in the previous section and select Excel Workbook as the output file format.

The first row of the Excel table lists data names (see Appendix A) and the second row provides data codes, which identify recorded data points (see Modbus communications guide for data codes) that may be useful for automated table processing.

Each table row is provided with the device identifier that you can define in the meter database (see [Creating a New Site for your Meter](#)).

## Archiving Files

Microsoft Access databases tend to grow fast. Databases above 0.5 Gigabytes can drastically slow down file operations.

To avoid enormous growing files, you can either periodically change the target database, or use the Upload Scheduler's file archiver to automatically move older data to archives.

The Upload Scheduler archives files upon a weekly, monthly or yearly schedule. When archiving data, a new database is created to where older data from your present database with the expired archiving date is moved.

An archive file keeps the original database name to which the date of the oldest database record is added, so you can easily identify your archives and work with them as you work with a regular database.

To provide a schedule for archiving files:

1. When defining a schedule for uploading files from your meter, click on Configure or double click on the site row.
2. Click Auto Archive.

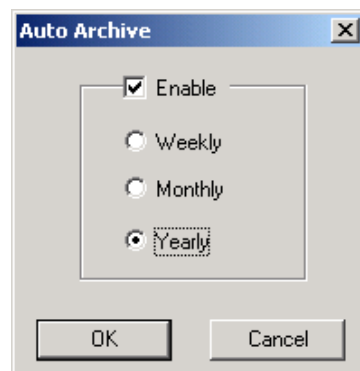

3. Check the Enable box and select a periodic schedule for archiving your files for this site.
4. Click OK.

To avoid archiving partially updated data, archiving is performed in a day after expiring a scheduled period and not before 2 hours a.m.

# Chapter 9 Viewing Files and Reports

## Operations with Files

Files you read from the meters are stored in one or in a number of tables in the meter database. Sections of multi-section files like waveforms, load profiles and PQ statistics files are stored in multiple tables – each file section in a separate database table.

### Opening a Database Table

To open a database table:

1. Click on the Open button  on the PAS toolbar, or select "Open..." from the File menu.
2. Select "Access Database (\*.mdb)" in the "Files of type" box; select a directory where your files are located, and point to the file you wish to open.
3. Select a desired table on the right pane, and then click Open, or double click on the table name.

Names of the last 16 files you opened are stored in the File menu, so you can select them directly from the menu.

### Saving Data to a File

To save data from the open database table to a file:

1. Click on the Save button , and select a directory where you want your file to be stored.
2. Select a database or type the name for a new database.
3. Click Save.

To avoid confusion, do not store data files into the "Sites" directory where site databases are located.

## Viewing Options

### Customizing Views

#### Changing Date Order

To change the way PAS displays the date:

1. Select Options from the Tools menu and click on the Preferences tab.
2. Select the preferred date order.
3. Click OK.

#### Selecting Timestamp Format

The timestamp is normally recorded and displayed on the screen at a 1-ms resolution. If you have an application that

does not support this format, you may instruct PAS to drop milliseconds.

To change the way PAS records and displays the timestamp:

1. Select Options from the Tools menu and click on the Preferences tab.
2. Select the preferred timestamp format.
3. Click OK.

## Working with Tables

### Selecting Font and Grid

To change the table font or a type of the grid lines:

1. Click with right mouse button on the table, select Options and click on the Table tab.
2. Select the font type and size and how you wish the table grid to be shown.
3. Click OK.



### Selecting Primary and Secondary Units

Voltages and currents can be displayed in primary or secondary units.

To change units, click on the table with the right mouse button, select Options, select the desired units for voltages and currents, and then click OK.

### Copying a Table

To copy the entire table, or its part, into the Clipboard or into another application such as Microsoft Excel or Word:

1. Click on the data window with the right mouse button and choose Select All, or click on the upper-left corner of the table (where the "No." label is commonly displayed).
2. Click with the right mouse button on the window again and choose Copy, or click on the Copy button  on the PAS toolbar.
3. Run the application to which you want to copy data, position the cursor at the correct place.
4. Click the Paste button  on the application's toolbar or select Paste from the Edit menu.

When copying, table columns are separated by a tab character.

### Printing a Table

To check how your document appears on a printed page, select Print Preview from the File menu.

To print a table to a printer, click on the print button  on the toolbar, select a printer and click OK.

## Working with Graphic Windows

### Selecting Channels

To select the channels you want to view on the screen, click on the graph window with the right mouse button, select "Channels...", check the channels you want displayed, and then click OK.

Checkboxes for channels that are not available in the present view are dimmed.

### Selecting Primary and Secondary Units

Voltages and currents can be displayed in primary or secondary units.

To change units, click on the table with the right mouse button, select Options, select the desired units for voltages and currents, and then click OK.

### Selecting the Time Axis

In waveform views, the horizontal axis can be displayed either in absolute time with date and time stamps, or in milliseconds relatively to the beginning of a waveform.

To change the time units, click on the waveform window with the right mouse button, select "Options...", click on the "Axes" tab, select the desired units, and then click OK.

### Selecting Line Styles and Colors

Channel waveforms can be displayed using different colors and line styles.

To change the colors or line styles, click on the graph window with the right mouse button, select "Options...", click on the Display tab, adjust colors and styles, and then click OK.

### Selecting Grid and Frame Colors

Click on the graph window with the right mouse button, select "Options...", click on the Display tab

To change the color or style of the grid lines, click on the Grid line on the left pane, and then select the color and style for the grid. To disable the grid, uncheck the Grid Visible box.

To change the window frame color to white, check the White Frame box at right.

### Using Marker Lines

The waveform and trend windows have two blue dashed marker lines. The left marker indicates the starting position and the right marker indicates the end position for calculating the average and peak values.

The minimum distance between the two markers is exactly one cycle.

To change the marker position, click on the  button, or click on the window with the right mouse button and select



Set Marker, and then click on the point where you want to put the marker.

You can also drag both markers with the mouse, or use the right and left arrow keys on your keyboard to change the marker position. Click on the graph pane to allow the keyboard to get your input before using the keyboard.

### Delta Measurements



To measure the distance between two waveform or trend points, click on the Delta button , then click on the first point, and then click on the second point.

The first reference point is still frozen until you close and reopen Delta, while the second point can be placed anywhere within the graph line. You can measure a delta in both directions.

To disable delta measurements, click on the Delta button once again.

### Using a Zoom

You can use a horizontal and, for waveforms, also a vertical, zoom to change size of your graph.

Use the  buttons on your local toolbar to zoom in and zoom out. One click gives you a 100-percent horizontal or 50-percent vertical zoom. Two buttons  representing magnifying glasses give you a proportional zoom in both directions.

### Changing Region Size

In overlapped waveforms and in the ITI curve graph, you can change the scale of a selected graph region.

Click on the graph window with the right mouse button, click 'Zoom', point onto one of the corners of the region you want to zoom in, press and hold the left mouse button, then point to another corner of the selected region and release the mouse button.

### Copying a Graph

To copy a graph, or its part, into the Clipboard or into another application such as Microsoft Excel or Word:

1. Click on the graph window with the right mouse button and choose Copy All, or Copy Waveform. Some windows may have additional options.
2. Position the cursor at the correct place where you wish to copy the graph.
3. Click the Paste button  on the application's toolbar or select Paste from the Edit menu.

### Printing a Graph

To check how the graph appears on a printed page, select Print Preview from the File menu.

To print a graph to a printer, click on the print button  on the toolbar, select a printer and click OK.

## Viewing the Event Log

The Event log contains time-tagged events related to configuration changes, resets, device diagnostics, and setpoint operations.

The Event log is displayed in a tabular view, one event per row. Use the scroll bar to view the entire log contents.

No.	Date/Time	Event	Cause	Point/Source	Value	Effect	Target
56	02/06/09 19:58:56.299	SP6:54	SP EVENT	VDC	0.00	SP. operated	#6
57	02/06/09 19:58:57.306	SP6:54	SP EVENT	VDC	7.86	SP. released	#6
58	02/06/09 20:26:33.940	EV:55	COMM	RTC	02/06/09 20:26:32	RTC set	
59	03/06/09 00:15:46.747	EV:56	COMM	Data memory		Cleared max dmd	POWER
60	03/06/09 00:15:47.435	EV:57	COMM	Data memory		Cleared max dmd	VOLT/AMP
61	03/06/09 00:37:04.097	EV:58	COMM	RTC	03/06/09 00:37:05	RTC set	
62	03/06/09 09:18:13.317	EV:59	COMM	Basic setup		Setup change	
63	03/06/09 09:18:59.000	EV:60	COMM	RTC	03/06/09 09:18:58	RTC set	
64	03/06/09 10:07:40.000	EV:61	COMM	RTC	03/06/09 10:07:37	RTC set	
65	03/06/09 11:02:56.000	EV:62	COMM	RTC	03/06/09 11:02:58	RTC set	
66	03/06/09 12:59:46.000	EV:63	COMM	RTC	03/06/09 12:59:46	RTC set	
67	03/06/09 13:00:41.000	EV:64	COMM	RTC	03/06/09 13:00:41	RTC set	
68	04/06/09 00:18:32.457	EV:65	COMM	Data memory		Cleared max dmd	POWER
69	04/06/09 00:18:33.161	EV:66	COMM	Data memory		Cleared max dmd	VOLT/AMP
70	04/06/09 00:43:25.999	EV:67	COMM	RTC	04/06/09 00:43:23	RTC set	
71	07/06/09 09:55:32.616	EV:68	EXTERNAL	Power down			
72	07/06/09 09:55:33.000	EV:69	SELF-CHECK	RTC	30/11/20 01:40:45	RTC set	
73	07/06/09 09:55:33.000	EV:70	EXTERNAL	Power up			
74	07/06/09 09:55:36.525	SP6:71	SP EVENT	VDC	0.00	SP. operated	#6
75	07/06/09 09:55:37.515	SP6:71	SP EVENT	VDC	7.24	SP. released	#6
76	07/06/09 13:09:47.000				07/06/09 10:53:31	RTC set	
77	07/06/09 15:31:45.519				07/06/09 10:53:31	RTC set	
78	07/06/09 15:31:47.517	SP6:73	SP EVENT	VDC	5.59	SP. operated	#6
79	07/06/09 15:32:17.484	SP6:74	SP EVENT	VDC	8.28	SP. released	#6
80	07/06/09 16:20:38.434	EV:75	EXTERNAL	Power down			
81	07/06/09 16:20:39.000	EV:76	SELF-CHECK	RTC	30/11/20 01:40:41	RTC set	
82	07/06/09 16:20:39.000	EV:77	EXTERNAL	Power up			
83	07/06/09 16:20:42.523	SP6:78	SP EVENT	VDC	0.00	SP. operated	#6
84	07/06/09 16:20:43.533	SP6:78	SP EVENT	VDC	7.66	SP. released	#6
85	08/06/09 09:11:32.000	EV:79	COMM	RTC	07/06/09 16:34:29	RTC set	
86	08/06/09 09:58:32.342	EV:80	COMM	Data memory		Cleared max dmd	POWER
87	08/06/09 09:58:33.108	EV:81	COMM	Data memory		Cleared max dmd	VOLT/AMP
88	08/06/09 10:32:44.878	EV:82	COMM	RTC	08/06/09 10:32:44	RTC set	
89	08/06/09 14:58:50.370	EV:83	COMM	Data memory		Cleared PQ Log	
90	09/06/09 00:06:04.632	EV:84	COMM	Data memory		Cleared max dmd	POWER
91	09/06/09 00:06:05.477	EV:85	COMM	Data memory		Cleared max dmd	VOLT/AMP
92	09/06/09 00:41:56.712	EV:86	COMM	RTC	09/06/09 00:41:55	RTC set	
93	10/06/09 00:16:23.933	EV:87	COMM	Data memory		Cleared max dmd	POWER

See [Working with Tables](#) for more information on viewing options.

### Filtering and Sorting Events

You can use filtering to find and work with a subset of events that meet the criteria you specify.

Click on the Filter button , or click on the report window with the right mouse button and select "Filter...". Check the causes of events you want to display, and then click OK. PAS temporary hides rows you do not want displayed.

To change the default sorting order based on the date and time, click on the Sort button , or click on the report window with the right mouse button and select "Sort...", check the desired sort order, and then click OK.

### **Linking to Waveforms and Data Records**

If a setpoint is programmed for logging setpoint operation events and it could trigger waveform or data recording, PAS automatically establishes links between the event and other database records where it finds a relationship with the event.

The event ID for which PAS found related data is blue colored. Click on the colored ID to check a list of the event links. Click on a list item to move to the related waveform or data log record.

### **Retrieving Waveforms Online**

If you found an event for which you expect a waveform to be recorded in the meter, but it has not yet been stored to the database, you can retrieve it online.

Events for which PAS did not find a corresponding waveform in the database are still black colored.

Click on the event ID, then click on the "Retrieve Waveform" prompt and point to a database to which you want the waveform to be stored.

## Viewing the Power Quality Event Log

The EN 50160 PQ event log stores individual time-tagged power quality events.

The PQ log file is displayed in a tabular view, one event per row. Use the scroll bar to view the entire log contents.

No.	Date/Time	Event	Fault Category	Phase	Fault Magnitude	PU	Duration
1	27/08/06 23:00:01.258	PQE4:135	Flicker severity	V3 Plt	3.08		1:59:59.223000
2	29/08/06 15:00:01.204	PQE4:136	Flicker severity	V1 Plt	1.88		2:00:00.346000
3	29/08/06 15:00:01.204	PQE4:136	Flicker severity	V2 Plt	1.87		2:00:00.346000
4	29/08/06 15:00:01.204	PQE4:136	Flicker severity	V3 Plt	1.97		2:00:00.346000
5	02/09/06 02:03:35.071	PQE5:137	Voltage dip	V12	17235	0.78	0:00:00.049000
6	02/09/06 03:00:01.273	PQE4:138	Flicker severity	V1 Plt	4.33		1:59:59.779000
7	02/09/06 03:00:01.273	PQE4:138	Flicker severity	V2 Plt	1.45		1:59:59.779000
8	02/09/06 03:00:01.273	PQE4:138	Flicker severity	V3 Plt	1.25		1:59:59.779000
9	03/09/06 19:00:01.179	PQE4:139	Flicker severity	V2 Plt	2.05		1:59:59.396000
10	06/09/06 00:51:00.033	PQE5:140	Voltage dip	V23	16634	0.76	0:00:00.060000
11	06/09/06 01:00:01.332	PQE4:141	Flicker severity	V1 Plt	1.75		3:59:59.423000
12	06/09/06 01:00:01.332	PQE4:141	Flicker severity	V2 Plt	4.97		3:59:59.423000
13	06/09/06 01:00:01.332	PQE4:141	Flicker severity	V3 Plt	1.81		3:59:59.423000
14	06/09/06 01:04:48.105	PQE5:142	Voltage dip	V23	15355	0.70	0:00:00.100000
15	07/09/06 13:11:30.019	PQE1:143	Power frequency		49.48	0.990	0:00:09.989000
16	08/09/06 07:32:05.993	PQE5:144	Voltage dip	V12	5096	0.23	0:00:00.110000
17	08/09/06 07:32:05.993	PQE5:144	Voltage dip	V23	4930	0.22	0:00:00.110000
18	08/09/06 07:32:05.993	PQE5:144	Voltage dip	V31	5222	0.24	0:00:00.110000
19	08/09/06 07:32:06.283	PQE7:145	Temporary overvoltage	V12	24287	1.10	0:00:15.533000
20	08/09/06 07:32:06.283	PQE7:145	Temporary overvoltage	V23	24278	1.10	0:00:15.533000
21	08/09/06 07:32:06.283	PQE7:145	Temporary overvoltage	V31	24314	1.11	0:00:15.533000
22	08/09/06 09:00:00.502	PQE4:146	Flicker severity	V1 Plt	9.48		2:00:00.808000
23	08/09/06 09:00:00.502	PQE4:146	Flicker severity	V2 Plt	9.88		2:00:00.808000
24	08/09/06 09:00:00.502	PQE4:146	Flicker severity	V3 Plt	9.58		2:00:00.808000
25	09/09/06 23:00:01.063	PQE4:147	Flicker severity	V2 Plt	2.33		2:00:00.240000
26	10/09/06 10:25:52.392	PQE7:148	Temporary overvoltage	V12	24344	1.11	0:00:41.917000
27	10/09/06 10:25:52.392	Waveform Log 1	10/09/06 10:25:52.332	V23	24278	1.10	0:00:41.917000
28	10/09/06 10:25:52.392	PQE7:149	Temporary overvoltage	V31	24345	1.11	0:00:41.917000
29	10/09/06 14:08:09.574	PQE5:149	Voltage dip	V12	5778	0.26	0:00:00.170000
30	10/09/06 14:08:09.574	PQE5:149	Voltage dip	V23	5845	0.27	0:00:00.170000
31	10/09/06 14:08:09.574	PQE5:149	Voltage dip	V31	6031	0.27	0:00:00.170000
32	10/09/06 14:08:10.014	PQE7:150	Temporary overvoltage	V12	24344	1.11	0:00:00.170000
33	10/09/06 14:08:10.014	PQE7:150	Temporary overvoltage	V31	24257	1.10	0:00:00.170000
34	10/09/06 14:08:11.824	PQE7:151	Temporary overvoltage	V12	24567	1.12	0:00:23.490000
35	10/09/06 14:08:11.824	PQE7:151	Temporary overvoltage	V23	24502	1.11	0:00:23.490000
36	10/09/06 14:08:11.824	PQE7:151	Temporary overvoltage	V31	24585	1.12	0:00:23.490000
37	10/09/06 15:00:00.864	PQE4:152	Flicker severity	V1 Plt	9.02		1:59:59.981000

See [Working with Tables](#) for more information on viewing options.

### Filtering and Sorting Events

To filter events, click on the Filter button , or click on the report window with the right mouse button and select "Filter...", check the categories of events you want to display, and then click OK.

To change the default event sorting order, click on the Sort button , or click on the report window with the right mouse button and select "Sort...", check the desired sort order, and then click OK.

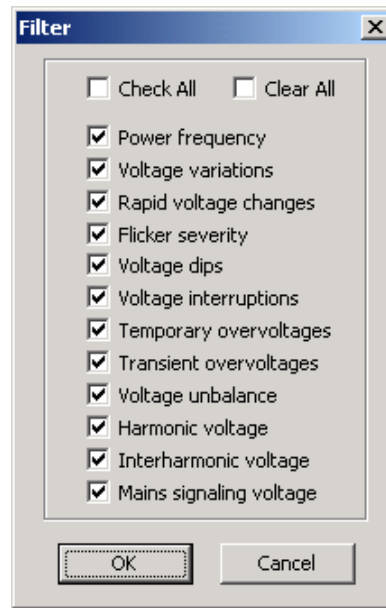

### Linking to Waveforms and Data Records

PQ events for which PAS found related links are blue colored. Click on the colored ID to check a list of the event links. Click on a list item to move to the related waveform or data log records. Data records associated with the event are taken into a separate window for easy viewing and trending.

### Retrieving Waveforms Online

If you found an event for which you expect a waveform to be recorded in the meter, but it has not yet been stored to the database, you can retrieve it online.

Events for which PAS did not find a corresponding waveform in the database are still black colored.

Click on the event ID, then click on the "Retrieve Waveform" prompt and point to a database to which you want the waveform to be stored.

### Viewing the ITI (CBEMA) Curve

Impulsive transients and short-duration voltage variations (sags and swells) can be viewed as magnitude/duration pairs on the ITIC (the Information Technology Industry Council, formerly CBEMA) curve chart. To view an ITI curve chart, click on the "ITI" button on the window toolbar.

To view the event details, click on the event point with the left mouse button. To directly move to the related power quality report entry or to a waveform record, click on the corresponding list item with the left mouse button.

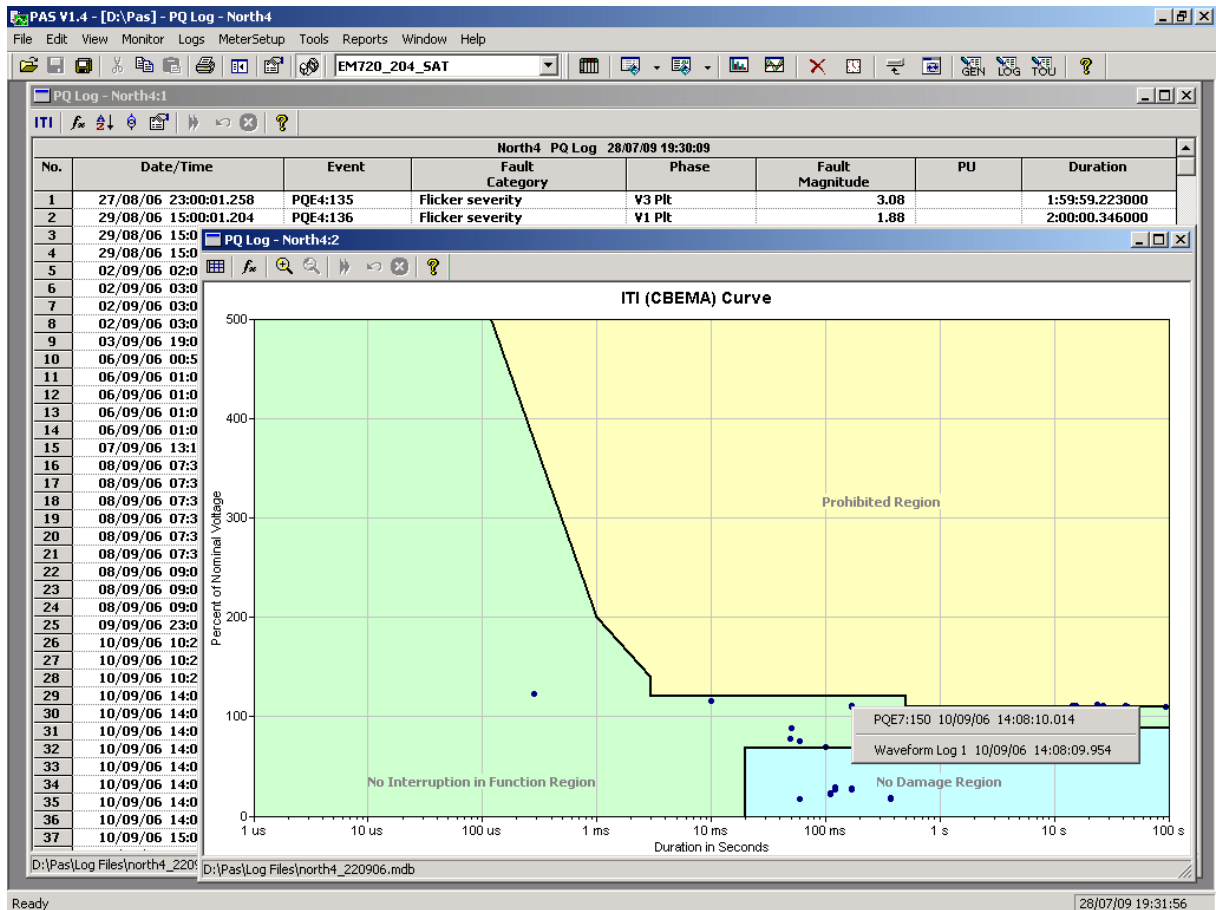

See [Using a Zoom](#) and [Changing Region Size](#) for information on how to change the graph scale to separate closely located elements.

## Viewing the Fault Log

The Fault recorder stores time-tagged fault events.

Fault log files are displayed in a tabular view. Use the scroll bar to see the entire log contents.

No.	Date/Time	Event	Fault Category	Phase	Amps Magnitude	PU	Volts Magnitude	PU	Duration
1	10/07/03 16:09:05.855	FE7:1	I4 (neutral) Current	L1	134.17	0.13	67788	1.02	0:00:00.033
2	10/07/03 16:09:05.855	FE7:1	I4 (neutral) Current	L2	124.91	0.12	67915	1.02	0:00:00.033
3	10/07/03 16:09:05.855	FE7:1	I4 (neutral) Current	L3	122.47	0.12	63705	0.96	0:00:00.033
4	10/07/03 16:31:00.521	FE6:2	Undervoltage	L1	268.66	0.27	54994	0.83	0:00:00.083
5	10/07/03 16:31:00.521	FE6:2	Undervoltage	L2	250.25	0.25	55745	0.84	0:00:00.083
6	10/07/03 16:31:00.521	FE6:2	Undervoltage	L3	218.65	0.22	54860	0.83	0:00:00.083
7	10/07/03 16:50:49.247	FE1:3	Zero-seq. Current	L1	459.13	0.46	54133	0.82	0:00:00.100
8	10/07/03 16:50:49.247	FE1:3	Zero-seq. Current	L2	415.32	0.42	67823	1.02	0:00:00.100
9	10/07/03 16:50:49.247	FE1:3	Zero-seq. Current	L3	252.93	0.25	67456	1.02	0:00:00.100
10	10/07/03 17:20:57.369	FE7:4	I4 (neutral) Current	L1	97.34	0.10	63647	0.96	0:00:00.050
11	10/07/03 17:20:57.369	FE7:4	I4 (neutral) Current	L2	60.75	0.06	68183	1.03	0:00:00.050
12	10/07/03 17:20:57.369	FE7:4	I4 (neutral) Current	L3	58.07	0.06	67588	1.02	0:00:00.050
13	12/07/03 05:50:49.698	FE1:5	Zero-seq. Current	L1	573.16	0.57	63949	0.96	0:00:00.033
14	12/07/03 05:50:49.698	FE1:5	Zero-seq. Current	L2	322.75	0.32	67551	1.02	0:00:00.033
15	12/07/03 05:50:49.698	FE1:5	Zero-seq. Current	L3	131.46	0.13	67424	1.02	0:00:00.033
16	12/07/03 05:50:49.733	FE7:6	I4 (neutral) Current	L1	503.15	0.50	64699	0.97	0:00:00.232
17	12/07/03 05:50:49.733	FE7:6	I4 (neutral) Current	L2	293.52	0.29	67678	1.02	0:00:00.232
18	12/07/03 05:50:49.733	FE7:6	I4 (neutral) Current	L3	118.82	0.12	67337	1.01	0:00:00.232
19	22/07/03 12:49:35.379	FE6:7	Undervoltage	L1	118.69	0.12	67113	1.01	0:00:00.066
20	22/07/03 12:49:35.379	FE6:7	Undervoltage	L2	410.10	0.41	59318	0.89	0:00:00.066
21	22/07/03 12:49:35.379	FE6:7	Undervoltage	L3	249.68	0.25	59185	0.89	0:00:00.066
22	22/07/03 12:49:35.862	FE1:8	Zero-seq. Current	L1	332.62	0.33	63711	0.96	0:00:00.060
23	22/07/03 12:49:35.862	FE1:8	Zero-seq. Current	L2	72.25	0.07	68226	1.03	0:00:00.060
24	22/07/03 12:49:35.862	FE1:8	Zero-seq. Current	L3	110.11	0.11	67709	1.02	0:00:00.060
25	22/07/03 12:49:35.923	FE7:9	I4 (neutral) Current	L1	171.70	0.17	66647	1.00	0:00:00.022
26	22/07/03 12:49:35.923	FE7:9	I4 (neutral) Current	L2	91.99	0.09	68463	1.03	0:00:00.022
27	22/07/03 12:49:35.923	Waveform Log 1 22/07/03 12:49:35.279			98.95	0.10	67636	1.02	0:00:00.022
28	22/07/03 12:51:04.478	FE5:10	Overcurrent	L1	235.04	0.24	67698	1.02	0:00:00.066
29	22/07/03 12:51:04.478	FE5:10	Overcurrent	L2	2625.05	2.63	60604	0.91	0:00:00.066
30	22/07/03 12:51:04.478	FE5:10	Overcurrent	L3	2686.08	2.69	59109	0.89	0:00:00.066
31	22/07/03 12:51:04.904	FE1:11	Zero-seq. Current	L1	3021.27	3.02	62006	0.93	0:00:00.066
32	22/07/03 12:51:04.904	FE1:11	Zero-seq. Current	L2	3185.30	3.19	62081	0.93	0:00:00.066
33	22/07/03 12:51:04.904	FE1:11	Zero-seq. Current	L3	389.28	0.39	68293	1.03	0:00:00.066
34	22/07/03 12:51:04.972	FE5:12	Overcurrent	L1	2588.68	2.59	64731	0.97	0:00:00.022
35	22/07/03 12:51:04.972	FE5:12	Overcurrent	L2	2754.52	2.75	64962	0.98	0:00:00.022
36	22/07/03 12:51:04.972	FE5:12	Overcurrent	L3	372.87	0.37	67355	1.01	0:00:00.022

See [Working with Tables](#) for more information on viewing options.

### Filtering and Sorting Events

To filter events, click on the Filter button , or click on the report window with the right mouse button and select "Filter...", check the categories of events you want to display, and then click OK.

To change the sorting order, click on the Sort button , or click on the report window with the right mouse button and select "Sort...", check a desired sort order, and then click OK.



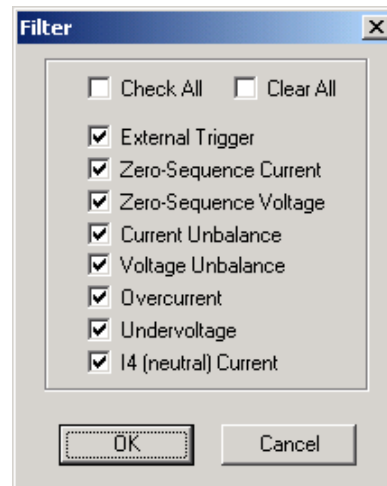

### Linking to Waveforms and Data Records

When displaying the fault report, PAS establishes links between the event and related waveforms and data log records. Fault events for which PAS finds related links are blue colored.

Click on the colored event ID with the left mouse button to check a list of the event links. Click on a list item to move to the related waveform or data log records. Data log records associated with the fault event are taken into a separate window for easy viewing and trending.

### Retrieving Waveforms Online

If you found an event for which you expect a waveform to be recorded in the meter, but it has not yet been stored to the database, you can retrieve it online.

Events for which PAS did not find a corresponding waveform in the database are still black colored.

Click on the event ID, then click on the "Retrieve Waveform" prompt and point to a database to which you want the waveform to be stored.

## Viewing the Data Log

Data log files can be displayed in a tabular view, one data record per row, or in a graphical view as a data trend graph.

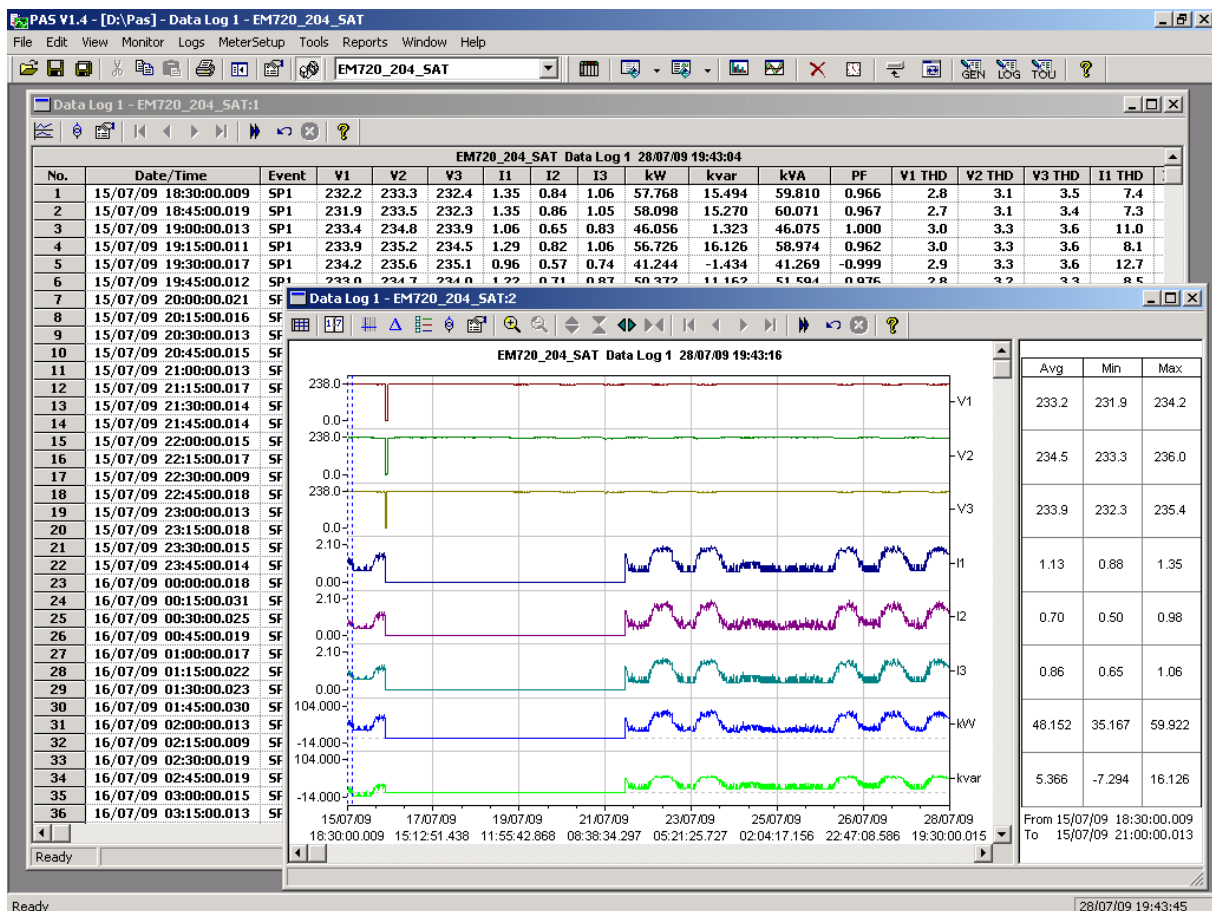

### Viewing Data Trend

To view data in a graphical form, click on the Data Trend  button on the local toolbar.

To change the time range for your graph, click on the Time Range button  on the local toolbar, and then select the desired date and time range.

## Viewing Waveforms

Waveforms can be displayed in five different views: as overlapped waveforms on a common time axis, individual waveforms using separate time axes, as a cycle-by-cycle plot of RMS values, as a frequency chart for voltage channels, and as a harmonic spectrum in a graph or in a table view.



Each waveform window has a local toolbar from where you can open another window to examine the waveforms in a different view. When you move to another waveform record, all views are updated simultaneously to reflect the changes.

You can open all five views together to analyze different properties of the waveform like a wave shape, waveform disturbance, unbalance, or spectrum.

## Viewing a Waveform Graph

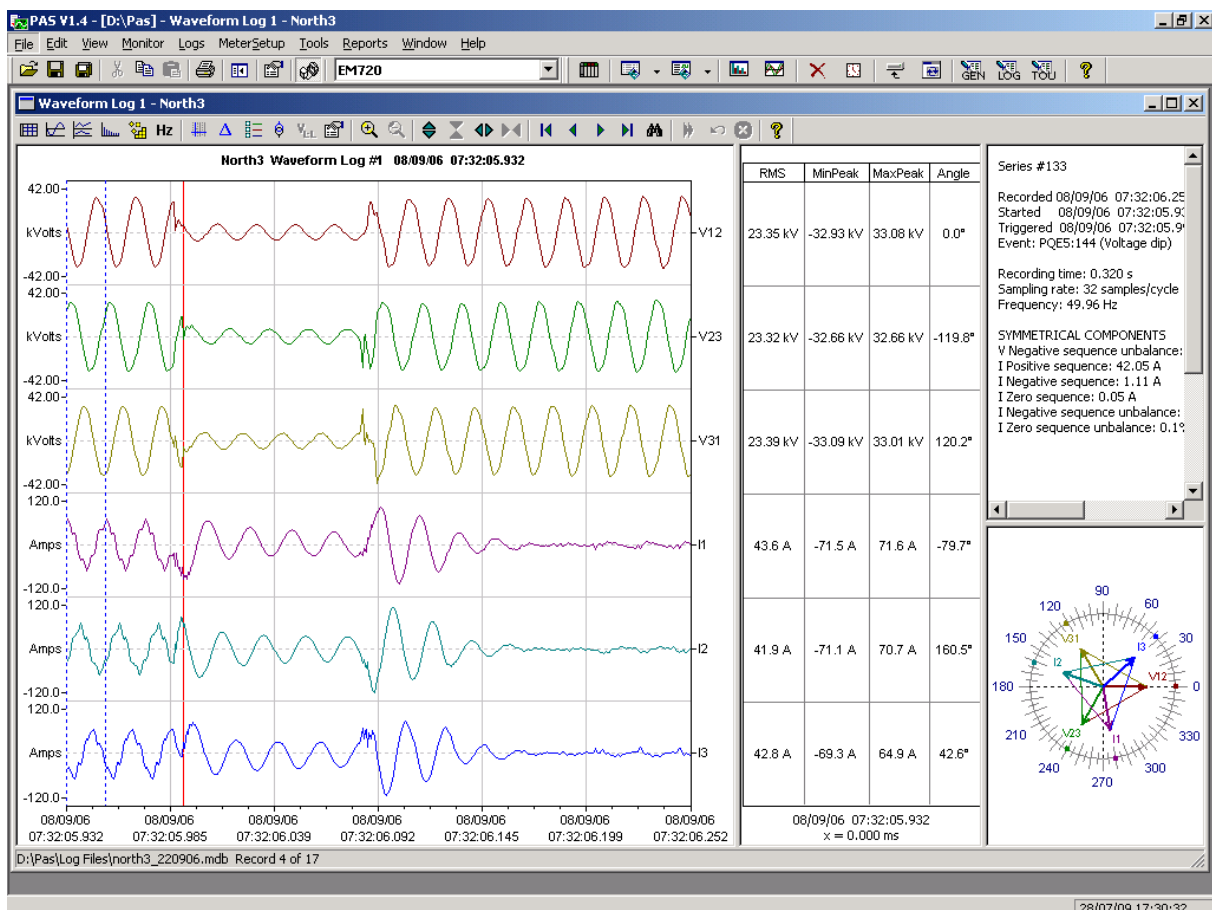
When you open a new file, PAS shows you a waveform graph with non-overlapped waveforms.



Click on the  button on the local toolbar to see overlapped waveforms; click on the  button for non-overlapped waveforms.

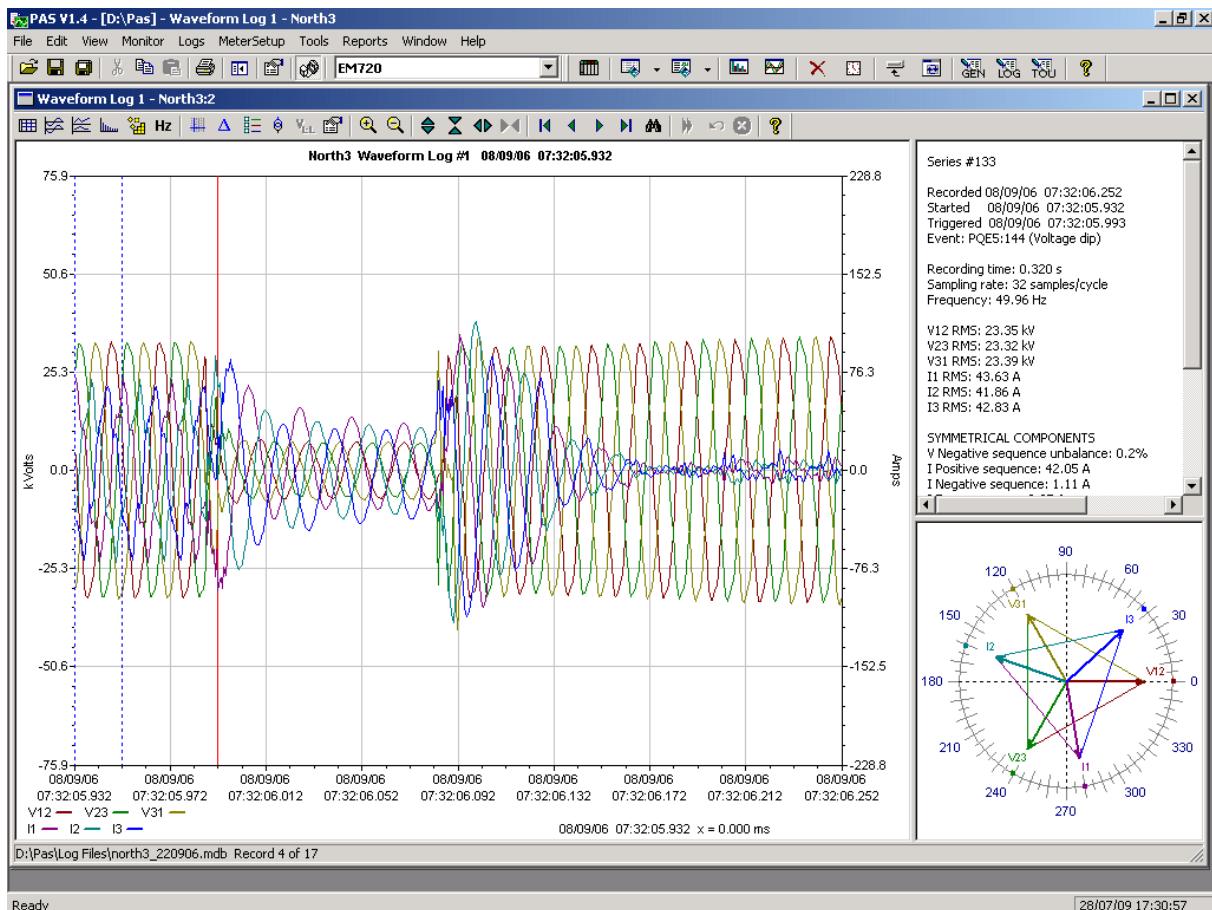

A waveform window displays up to 128 waveform cycles. If the waveform contains more cycles, the scroll bar appears under the waveform pane allowing you to scroll through the entire waveform.

### Scrolling through the Database

The status bar at the bottom shows you how many records the database contains.

Use green arrowheads  on the window toolbar to scroll through records.

If you wish to find a waveform related to a specific time, click on the  button on the window toolbar, select the time range and click OK.

## Viewing an RMS Plot

Click on the  button to see a cycle-by-cycle RMS plot of the voltage and current waveforms.

The graph shows the RMS points updated each half cycle.

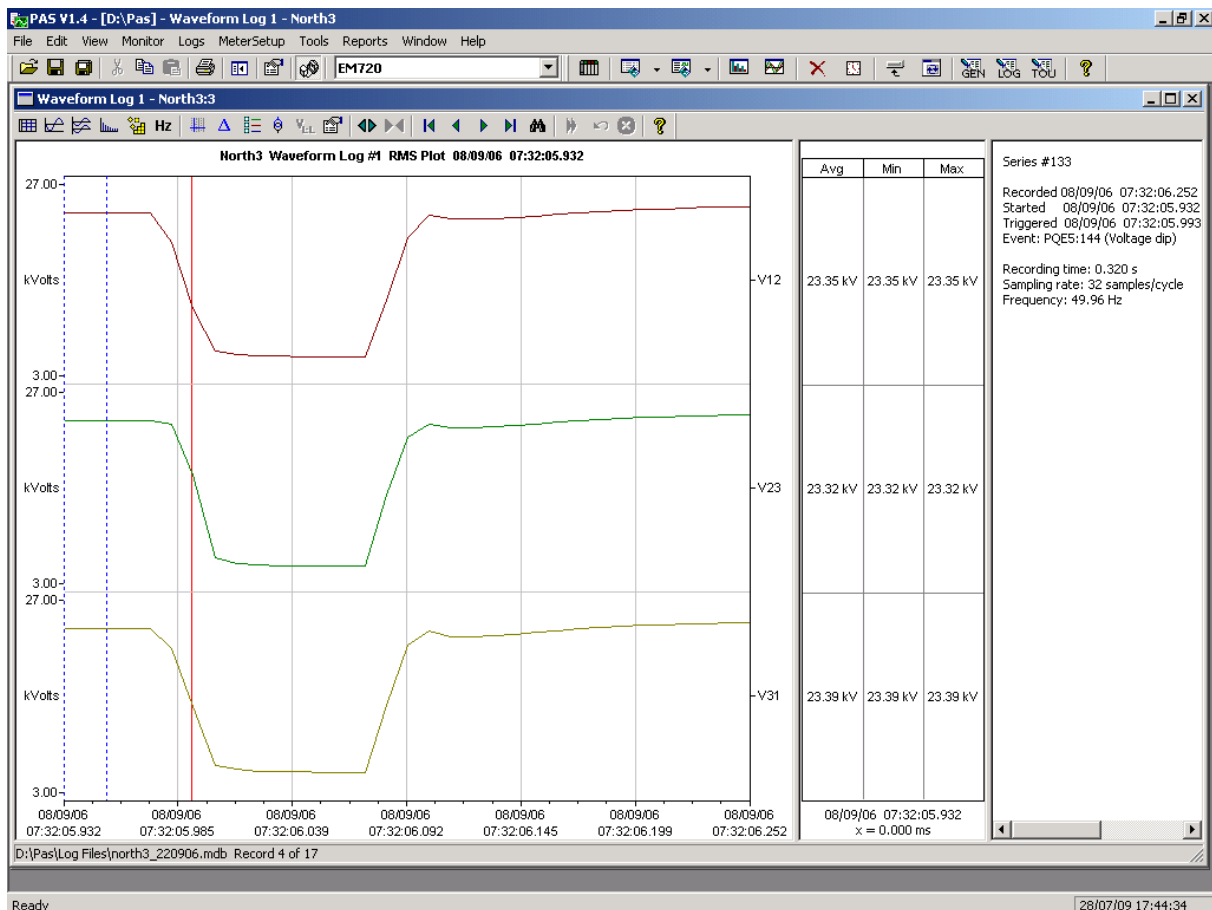

## Viewing a Frequency Plot

Click on the **Hz** button to view a cycle-by-cycle frequency plot for the sampled voltage waveforms.

## Viewing a Spectrum Chart

Click on the  button to view a spectrum chart for the selected waveform channel. PAS provides voltage, current, active power and reactive power spectrum charts.

To change a channel, click on the window with the right mouse button, select "Channels...", check the channel you want displayed, and then click OK.

Spectrum components are calculated over four cycles of the waveform from the point where the left marker line is located. If more than one view are open, PAS gives the priority to the overlapped waveform view.

The order of the highest displayed harmonic component is equal to the half sampling rate at which the waveforms are sampled minus one.

PAS can also give you indication on whether harmonic levels in the sampled waveforms exceed compliance limits defined by the power quality standards or local regulations.

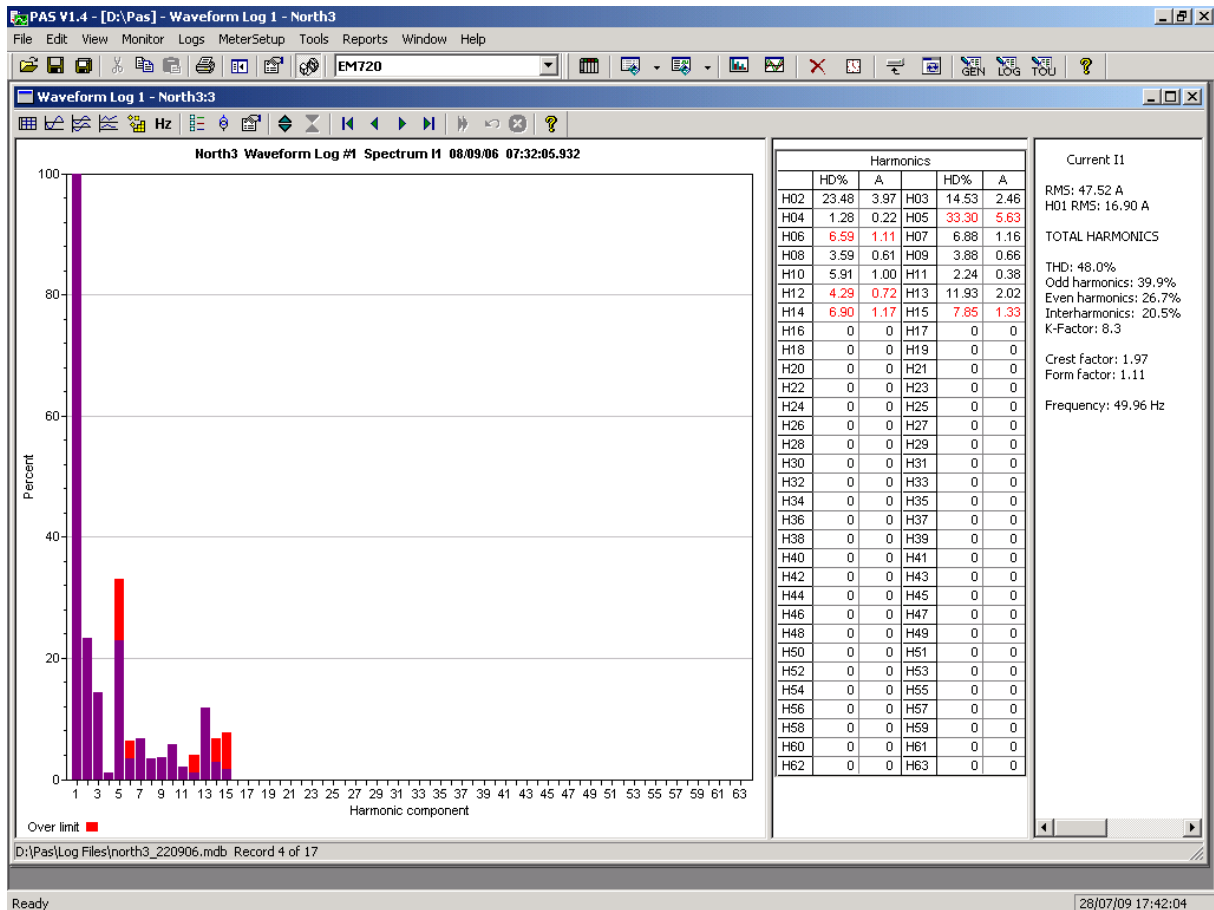

Limits

Voltage

Harm. Distortion, %			
H02	2.0	H03	5.0
H04	0.1	H05	6.0
H06	0.5	H07	5.0
H08	0.5	H09	1.5
H10	0.5	H11	3.5
H12	0.5	H13	3.0
H14	0.5	H15	0.5
H16	0.5	H17	2.0
H18	0.5	H19	1.5
H20	0.5	H21	0.5
H22	0.5	H23	1.5
H24	0.5	H25	1.5
H26	0.5	H27	1.5

Standard: EN 50160 400V-36.5kV

Enabled Default

Current

Harm. Emission, Amp			
H02	28.9	H03	48.1
H04	9.0	H05	28.9
H06	3.0	H07	41.2
H08	7.2	H09	9.6
H10	5.8	H11	39.4
H12	1.2	H13	27.8
H14	2.1	H15	1.4
H16	1.8	H17	13.6
H18	0.8	H19	9.1
H20	1.4	H21	0.7
H22	1.3	H23	7.5
H24	0.6	H25	4.0
H26	1.1	H27	0.5

Standard: G5/4 2001 400V

Enabled Default

Print OK Cancel Apply Help

To review or change harmonic limits:

1. Click on the spectrum window with the right mouse button and select "Limits...".
2. Select a harmonics standard, or select "Custom" and specify your own harmonic limits.
3. Check the Enabled box to visualize harmonic faults on the spectrum graph and in harmonic tables.

Harmonics that exceed selected compliance levels are colored in red on the graph and in the tables.

## Viewing a Spectrum Table

Click on the  button on the local toolbar to display the harmonics spectrum in a tabular view for a selected phase or for all phases together.

The spectrum table shows voltage, current, active power and reactive power harmonic components both in percent of the fundamental and in natural units, and harmonic phase angles.

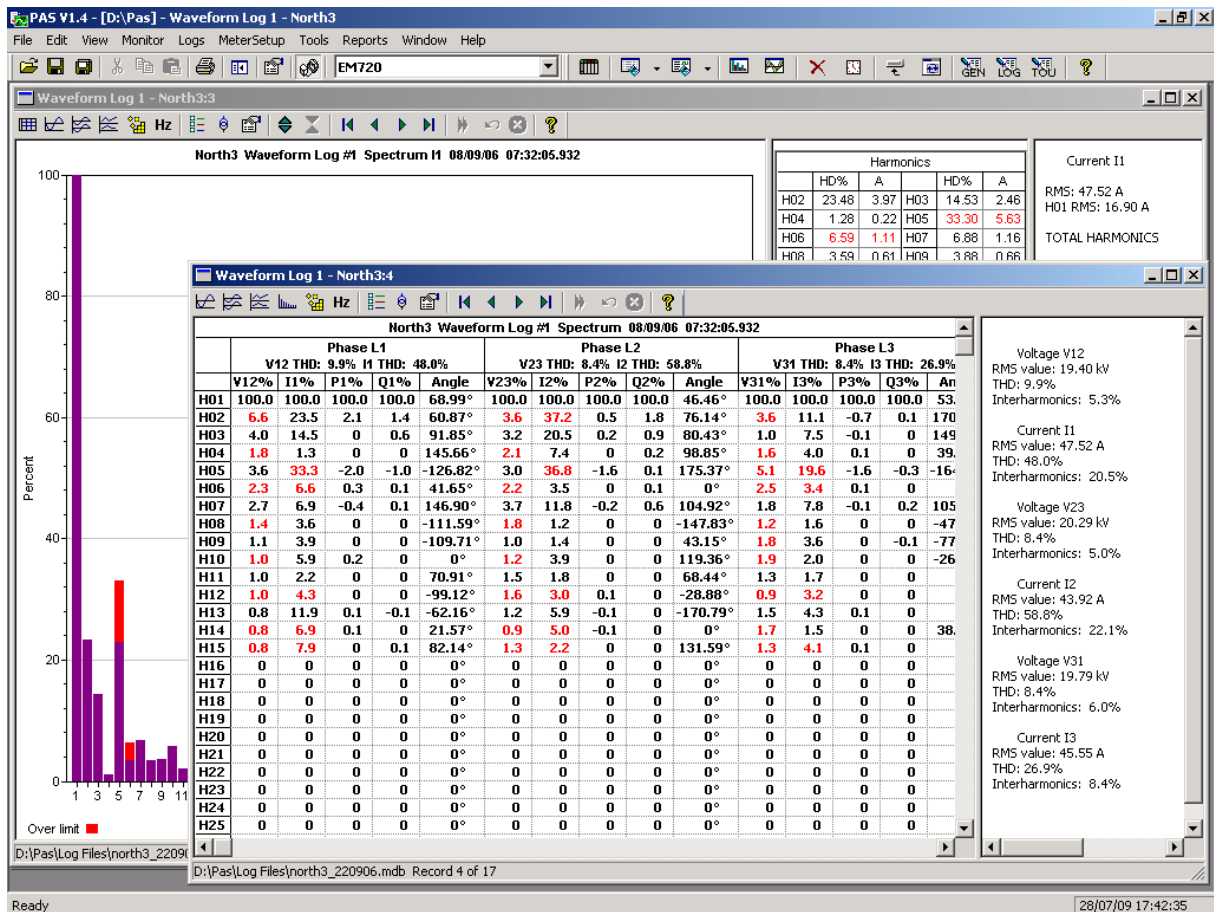

To change a phase, click on the window with the right mouse button, select "Options...", check the phase you want

## Waveform Viewing Options

See [Working with Graphic Windows](#) for more information on working with waveforms.

### Viewing Phasor Diagrams

The phasor diagrams show you relative magnitudes and angles of the three-phase voltage and current fundamental component. All angles are shown relative to the reference voltage channel.

To change the reference channel, click on the waveform window with the right mouse button, select "Options...", click on the "Phasor" tab, check the channel you want to make a reference channel, and then click "OK".

If you leave the Triangle box checked, PAS connects the ends of the voltage and current vectors showing you three-phase voltage and current triangles. This is useful when analyzing voltage and current unbalances.

Phasor diagrams are calculated over one waveform cycle pointed to by the left marker line. As you move the marker, the phasor diagrams are updated reflecting the new marker position.

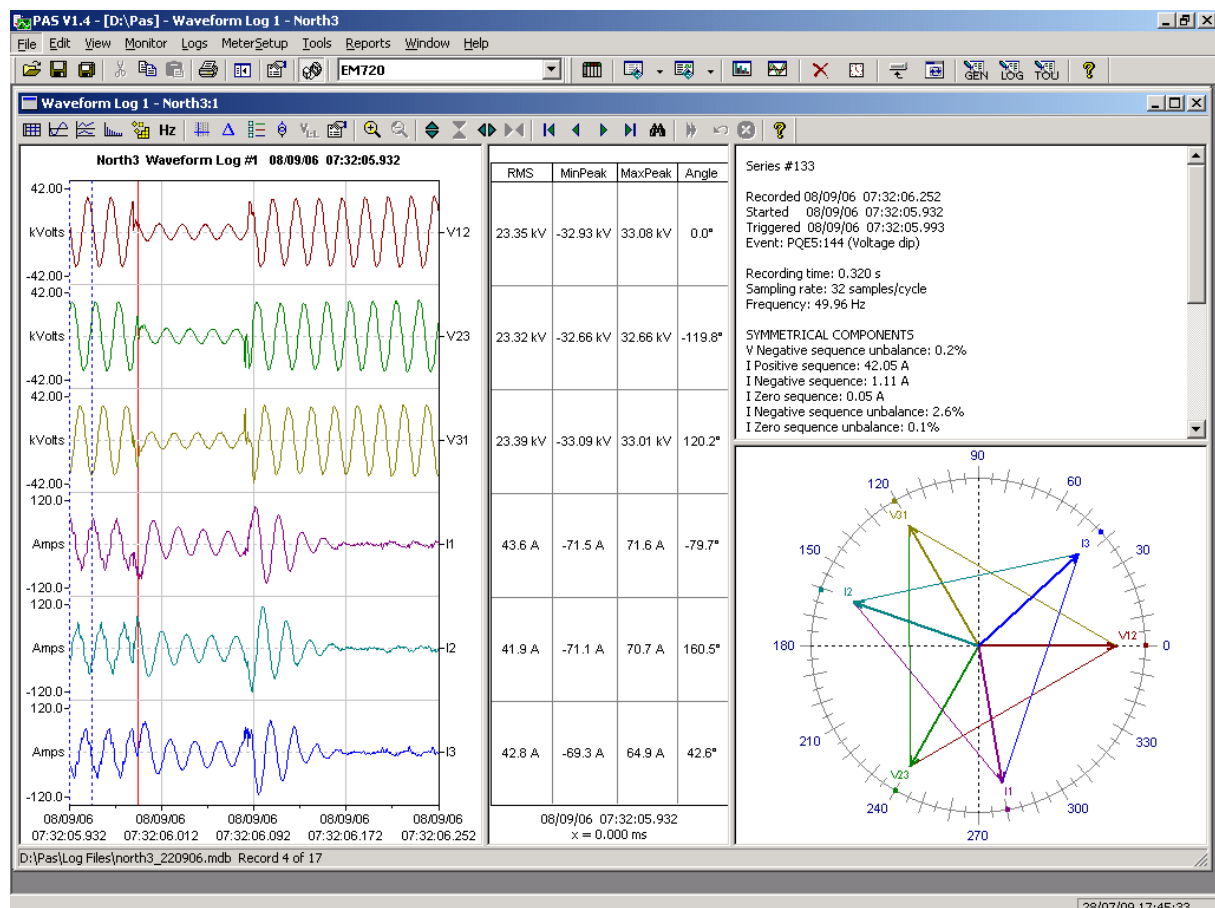

### Viewing Symmetrical Components

Waveform views have an additional pane at the right where PAS displays the symmetrical components for voltages and



currents, calculated for the point indicated by the left marker line.

To enable or disable the symmetrical components, click on the waveform window with the right mouse button, select "Options...", check or uncheck the "Symmetrical components" box on the "Channels" tab, and then click OK.

## Viewing Synchronized Waveforms

If you have a number of devices with synchronized clocks, you can view waveforms recorded at different locations in one window. PAS can synchronize the time axes for different waveforms so they could be displayed in a single plot.

To get synchronized waveforms:

1. Put the databases with waveforms into the same folder, or put the sites from which you uploaded data to the same group in the sites tree.
2. Open a waveform you want to synchronize with other waveforms, and then click on the Multi-site View button . PAS searches for time-coordinated waveforms that have the same time span as your selected waveform.

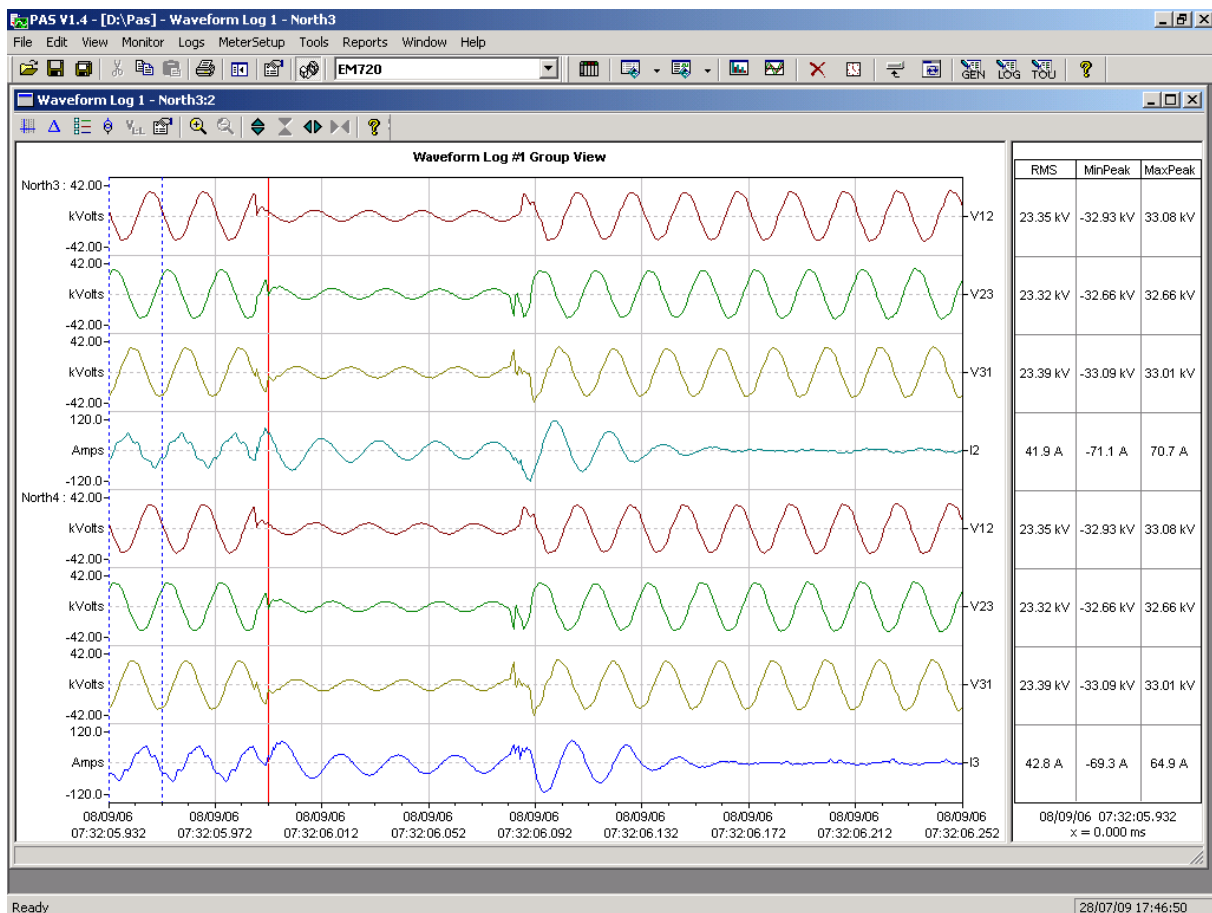

3. Check the sites you want to see displayed.

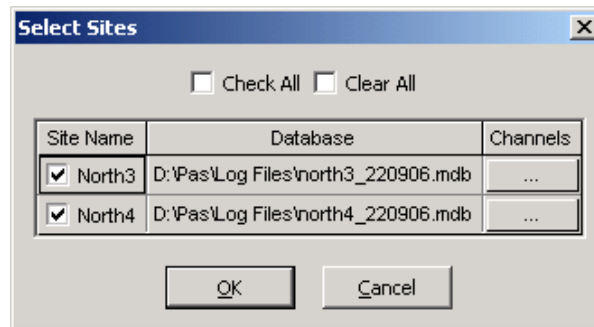

4. Click on the "Channels" button and select channels for each site.
5. Click OK.

To change the channels, click on the waveform window with the right mouse button and select "Channels...".

## Viewing EN50160 Statistics Reports

### Viewing the EN50160 Compliance Report

To get the EN50160 Compliance report, select "EN50160 Compliance Statistics" from the Reports menu, point to the database where you stored the retrieved statistics data, uncheck the voltage characteristics' tables you do not want to be reported, and then click Open.

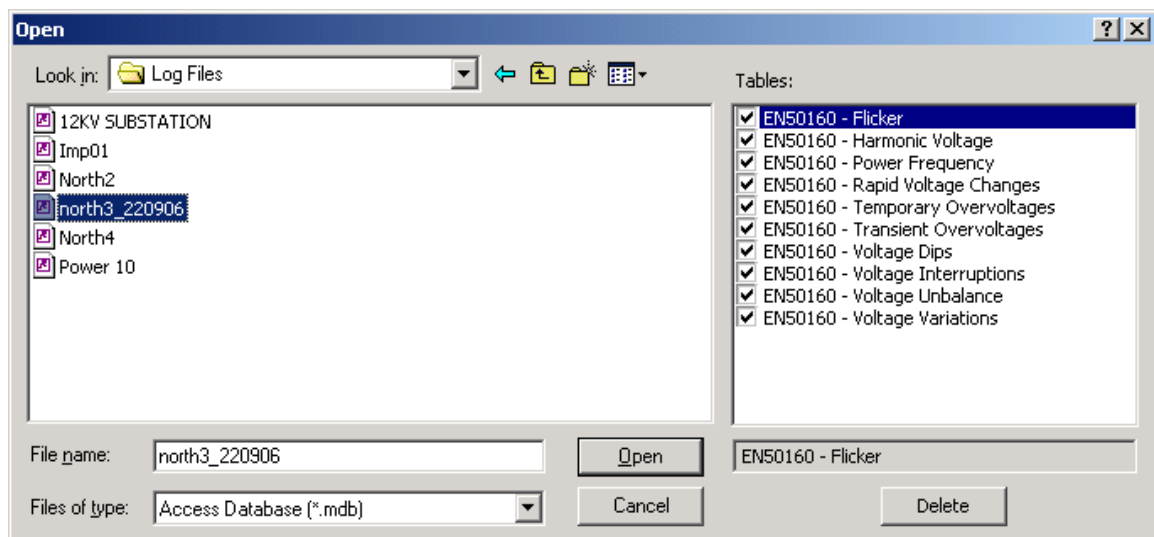

An example of the EN50160 compliance report is shown in the following picture.

The standard compliance statistics is reported within the selected time range on a daily, weekly or yearly basis depending on the observation periods stated in the EN50160 for voltage characteristics. If the time range includes a number of the observation intervals, each interval's statistics is given in a separate row. For power frequency, both weekly and yearly compliance statistics are provided.

For characteristics provided with definite limits, the report shows a percentage of the observation time within which the characteristic complied with the standard, e.g. 98% of the observations in a period of one week, and the total compliance indicator.

For voltage characteristics provided with indicative values, the report gives the yearly statistical data classified by voltage magnitude and duration.

PAS V1.3 - [E:\Projects\Pas\_V1] - EN50160 Compliance Report

File Edit View Monitor Logs MeterSetup Tools Reports Window Help

North 3

EN50160 Compliance Report

North3 Wed, Oct 18, 2006

**EN50160 Compliance Report**  
**26/08/06 - 16/09/06**

**Power Frequency**

From	To	In-service time, %	Compliance +/-1%, % of time	Compliance +4/-6%, % of time	Min Frequency Hz	Max Frequency Hz	Standard Compliance
26/08/06	26/08/06	77.85	100.00	100.00	49.56	50.17	Ok
27/08/06	02/09/06	100.00	100.00	100.00	49.59	50.21	Ok
03/09/06	09/09/06	100.00	100.00	100.00	49.48	50.16	Ok
10/09/06	16/09/06	100.00	99.96	100.00	49.10	50.23	Ok
Annual report							
26/08/06	16/09/06	7.25	99.99	100.00	49.10	50.23	Ok

**Voltage Variations**

From	To	In-service time, %	Compliance +/-10%, % of time	Compliance +10/-15%, % of time	V1 Min	V1 Max	V2 Min	V2 Max	V3 Min	V3 Max	Standard Compliance
26/08/06	26/08/06	77.78	100.00	100.00	23060	23719	22990	23663	23057	23748	Ok
27/08/06	02/09/06	100.00	100.00	100.00	22998	23671	22929	23596	23011	23703	Ok
03/09/06	09/09/06	100.00	100.00	100.00	23021	23701	22989	23608	23050	23712	Ok
10/09/06	16/09/06	100.00	100.00	100.00	23002	23792	22949	23728	23010	23805	Ok

**Voltage Dips**

Residual Voltage (u), %Un	Duration (t)						
	t < 100ms	t < 500ms	t < 1s	t < 3s	t < 20s	t < 60s	t < 180s
85 < u < 90	1	0	0	0	0	0	0
70 < u <= 85	2	0	0	0	0	0	0
40 < u <= 70	0	1	0	0	0	0	0
u <= 40	1	3	0	0	0	0	0

**Voltage Interruptions**

Duration (t) < 1s	Duration (t) < 180s	Duration (t) > 180s
0	0	0

**Temporary Overvoltages**

Magnitude (u), %Un	Duration (t)		
	t < 1s	1s <= t < 1 min	t >= 1 min

Ready 18/10/06 19:56:16

### Selecting the Time Range

To change the time range or contents of the report, click on the report with the right mouse button, select "Options...", select the required time range, check the voltage characteristics to be included in the report, and then click OK.

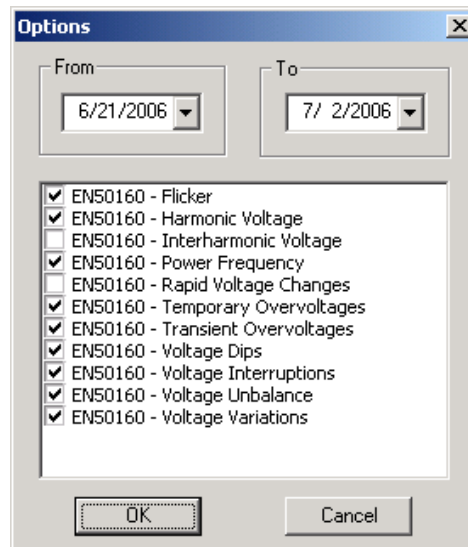

## Customizing Reports

If you wish to add a logo image, header and footer to your reports:

1. Select "Report Setup..." from the Reports menu, or click on the report window with the right mouse button, and then select "Report Setup...".

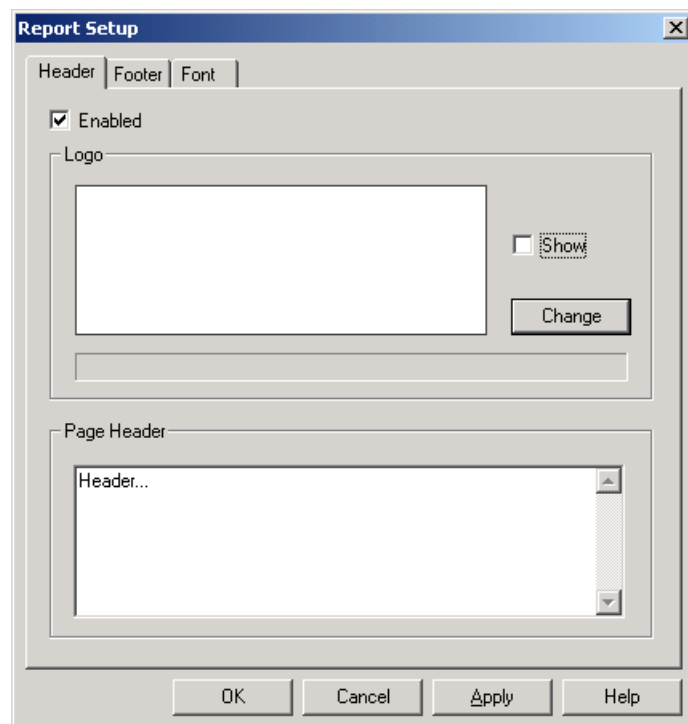

2. Click on the Change button and select a logo image file. Check the "Show" box to include your logo into a report.
3. Type the header text in the Page Header box. Check the "Enabled" box to include the header into a report.
4. Click on the Footer tab and type the footer text. Check the "Enabled" box to include the footer into a report.

5. Click OK.

Both the header and the footer may contain more than one line of the text. Use the Enter button to move to the next line as usually.

## **Viewing the EN50160 Online Statistics Report**

If you retrieved the EN50160 online statistics data, you can view the online report on the last retrieved statistics in the same manner as the EN50160 Compliance statistics report. Select "EN50160 Online Statistics" from the Reports menu, point to the database where you stored the retrieved online statistics, uncheck the voltage characteristics' tables that you do not want to be reported, and then click Open.

## **Viewing the EN50160 Harmonics Survey Report**

To view the EN50160 harmonics survey report on the collected statistics data, select "EN50160 Harmonics Survey" from the Reports menu, point to the database where you stored the retrieved statistics, uncheck the voltage channels which you do not want to be reported, and then click Open.

## Appendix A Parameters for Monitoring and Logging

The following table lists all electricity and status parameters available for monitoring via communication ports, for data logging, and for triggering setpoints.

Designation	Description
NONE	None (stub, read as zero)
<b>SETPOINTS</b>	<b>Setpoint Status</b>
SP1:16	Setpoints 1-16
<b>SPECIAL INPUTS</b>	<b>Special Inputs (setpoint triggers only)</b>
PHASE ROTATION	Phase rotation order (Error, Positive, Negative)
<b>EVENT FLAGS</b>	<b>User Event Flags</b>
EVENT FLAG 1:8	Event Flags 1-8
<b>STATIC EVENTS</b>	<b>Internal Static Events (setpoint triggers only)</b>
PHASE ORDER ERR	Phase order error
POS PHASE ORDER	Positive (ABC) phase order
NEG PHASE ORDER	Negative (ACB) phase order
PQ EVENT	PQ event. See <a href="#">Indication of Power Quality Events</a> .
FAULT EVENT	General fault event: fault recorder has been triggered. See <a href="#">Fault Indication and Cross Triggering</a> .
FAULT DETECTED	The embedded fault detector has detected a fault.
EXTERNAL TRIGGER	Fault recorder has been triggered via a digital input.
DEVICE FAULT	Device fault. See <a href="#">Device Fault Alarm</a> .
NO VOLTAGE	No measured voltage
<b>PULSED EVENTS</b>	<b>Internal Pulsed Events (setpoint triggers only)</b>
kWh IMP PULSE	kWh Import pulse
kWh EXP PULSE	kWh Export pulse
kvarh IMP PULSE	kvarh Import pulse
kvarh EXP PULSE	kvarh Export pulse
kvarh TOT PULSE	kvarh Total pulse
kVAh PULSE	kVAh pulse
START DMD INT	Start of power demand interval pulse
START TRF INT	Start of tariff interval pulse
<b>TIMERS</b>	<b>Interval Timers (setpoint triggers only)</b>
TIMER 1:4	Interval timer 1-4
<b>DIGITAL INPUTS</b>	<b>Digital Inputs</b>
DI1:8	Digital input status DI1:DI8
<b>PULSE INPUTS</b>	<b>Pulse Inputs (setpoint triggers only)</b>
DI1:8	Transition pulse on a digital input DI1:DI8
<b>RELAYS</b>	<b>Relays</b>
RO1:4	Relay status RO1:RO4
<b>COUNTERS</b>	<b>Pulse Counters</b>
COUNTER 1:8	Pulse counter 1-8
<b>TIME</b>	<b>Time/Date Parameters (setpoint triggers only)</b>
DAY OF WEEK	Day of week
YEAR	Year
MONTH	Month
DAY OF MONTH	Day of month
HOURS	Hours

Appendix A Parameters for Monitoring and Logging

Designation	Description
MINUTES	Minutes
SECONDS	Seconds
MINUTE INTERVAL	Minute interval: 1-5, 10, 15, 20, 30, 60 min
<b>SYMM COMP</b>	<b>Symmetrical Components</b>
V PSEQ	Positive-sequence voltage
V NSEQ	Negative-sequence voltage
V ZSEQ	Zero-sequence voltage
V NSEQ UNB%	Negative-sequence voltage unbalance
V ZSEQ UNB%	Zero-sequence voltage unbalance
I PSEQ	Positive-sequence current
I NSEQ	Negative-sequence current
I ZSEQ	Zero-sequence current
I NSEQ UNB%	Negative-sequence current unbalance
I ZSEQ UNB%	Zero-sequence current unbalance
<b>RMS (1/2 cycle)</b>	<b>1/2-Cycle Values</b>
V1	V1/V12 voltage <sup>1</sup>
V2	V2/V23 voltage <sup>1</sup>
V3	V3/V31 voltage <sup>1</sup>
V12	V12 voltage
V23	V23 voltage
V31	V31 voltage
I1	I1 current
I2	I2 current
I3	I3 current
I4	I4 current
In	In current
V ZERO-SEQ	Zero-sequence voltage <sup>7</sup>
I ZERO-SEQ	Zero-sequence current <sup>7</sup>
V UNB%	Voltage unbalance <sup>6</sup>
I UNB%	Current unbalance <sup>6</sup>
FREQ	Frequency (1-cycle)
<b>RT PHASE</b>	<b>1-Cycle Phase Values</b>
V1	V1/V12 voltage <sup>1</sup>
V2	V2/V23 voltage <sup>1</sup>
V3	V3/V31 voltage <sup>1</sup>
I1	I1 current
I2	I2 current
I3	I3 current
kW L1	kW L1 <sup>8</sup>
kW L2	kW L2 <sup>8</sup>
kW L3	kW L3 <sup>8</sup>
kvar L1	kvar L1 <sup>8</sup>
kvar L2	kvar L2 <sup>8</sup>
kvar L3	kvar L3 <sup>8</sup>
kVA L1	kVA L1 <sup>8</sup>
kVA L2	kVA L2 <sup>8</sup>
kVA L3	kVA L3 <sup>8</sup>
PF L1	Power factor L1 <sup>8</sup>
PF L2	Power factor L2 <sup>8</sup>



Appendix A Parameters for Monitoring and Logging

Designation	Description
PF L3	Power factor L3 <sup>8</sup>
V1 THD	V1/V12 voltage THD <sup>2,3</sup>
V2 THD	V2/V23 voltage THD <sup>2,3</sup>
V3 THD	V3/V31 voltage THD <sup>2,3</sup>
I1 THD	I1 current THD <sup>3</sup>
I2 THD	I2 current THD <sup>3</sup>
I3 THD	I3 current THD <sup>3</sup>
I1 KF	I1 K-Factor <sup>3</sup>
I2 KF	I2 K-Factor <sup>3</sup>
I3 KF	I3 K-Factor <sup>3</sup>
I1 TDD	I1 current TDD <sup>3</sup>
I2 TDD	I2 current TDD <sup>3</sup>
I3 TDD	I3 current TDD <sup>3</sup>
V12	V12 voltage
V23	V23 voltage
V31	V31 voltage
<b>RT LOW</b>	<b>1-Cycle Low Values on any Phase</b>
V LOW	Low line-to-neutral/line-to-line voltage <sup>1</sup>
I LOW	Low current
kW LOW	Low kW <sup>8</sup>
kvar LOW	Low kvar <sup>8</sup>
kVA LOW	Low kVA <sup>8</sup>
PF LAG LOW	Low lagging PF <sup>8</sup>
PF LEAD LOW	Low leading PF <sup>8</sup>
THD LOW	Low voltage THD <sup>2,3</sup>
V THD LOW	Low current THD <sup>3</sup>
KF LOW	Low K-Factor <sup>3</sup>
I TDD LOW	Low current TDD <sup>3</sup>
V L-L LOW	Low line-to-line voltage
<b>RT HIGH</b>	<b>1-Cycle High Values on any Phase</b>
V HIGH	High line-to-neutral/line-to-line voltage <sup>1</sup>
I HIGH	High current
kW HIGH	High kW <sup>8</sup>
kvar HIGH	High kvar <sup>8</sup>
kVA HIGH	High kVA <sup>8</sup>
PF LAG HIGH	High PF Lag <sup>8</sup>
PF LEAD HIGH	High PF Lead <sup>8</sup>
V THD HIGH	High voltage THD <sup>2,3</sup>
I THD HIGH	High current THD <sup>3</sup>
KF HIGH	High K-Factor <sup>3</sup>
I TDD HIGH	High current TDD <sup>3</sup>
V L-L HIGH	High line-to-line voltage
<b>RT TOTAL</b>	<b>1-Cycle Total Values</b>
kW	Total kW <sup>8</sup>
kvar	Total kvar <sup>8</sup>
kVA	Total kVA <sup>8</sup>
PF	Total PF <sup>8</sup>
PF LAG	Total PF lag <sup>8</sup>

Appendix A Parameters for Monitoring and Logging

Designation	Description
PF LEAD	Total PF lead <sup>8</sup>
kW IMP	Total kW import <sup>8</sup>
kW EXP	Total kW export <sup>8</sup>
kvar IMP	Total kvar import <sup>8</sup>
kvar EXP	Total kvar export <sup>8</sup>
V AVG	3-phase average line-to-neutral/line-to-line voltage <sup>1</sup>
V LL AVG	3-phase average line-to-line voltage
I AVG	3-phase average current
<b>RT AUX</b>	<b>1-Cycle Auxiliary Values</b>
I4	I4 current
In	In current
FREQ	Frequency
V UNB%	Voltage unbalance <sup>6</sup>
I UNB%	Current unbalance <sup>6</sup>
<b>AVR PHASE</b>	<b>1-Second Phase Values</b>
V1	V1/V12 voltage <sup>1</sup>
V2	V2/V23 voltage <sup>1</sup>
V3	V3/V31 voltage <sup>1</sup>
I1	I1 current
I2	I2 current
I3	I3 current
kW L1	kW L1
kW L2	kW L2
kW L3	kW L3
kvar L1	kvar L1
kvar L2	kvar L2
kvar L3	kvar L3
kVA L1	kVA L1
kVA L2	kVA L2
kVA L3	kVA L3
PF L1	Power factor L1
PF L2	Power factor L2
PF L3	Power factor L3
V1 THD	V1/V12 Voltage THD <sup>2,4</sup>
V2 THD	V2/V23 Voltage THD <sup>2,4</sup>
V3 THD	V3/V31 Voltage THD <sup>2,4</sup>
I1 THD	I1 Current THD <sup>4</sup>
I2 THD	I2 Current THD <sup>4</sup>
I3 THD	I3 Current THD <sup>4</sup>
I1 KF	I1 K-Factor <sup>4</sup>
I2 KF	I2 K-Factor <sup>4</sup>
I3 KF	I3 K-Factor <sup>4</sup>
I1 TDD	I1 Current TDD <sup>4</sup>
I2 TDD	I2 Current TDD <sup>4</sup>
I3 TDD	I3 Current TDD <sup>4</sup>
V12	V12 Voltage
V23	V23 Voltage
V31	V31 Voltage
V1x	V1x phase-to-ground voltage

Appendix A Parameters for Monitoring and Logging

Designation	Description
V2x	V2x phase-to-ground voltage
V3x	V3x phase-to-ground voltage
<b>AVR LOW</b>	<b>1-Second Low Values on any Phase</b>
V LOW	Low line-to-neutral/line-to-line voltage <sup>1</sup>
I LOW	Low current
kW LOW	Low kW
kvar LOW	Low kvar
kVA LOW	Low kVA
PF LAG LOW	Low lagging PF
PF LEAD LOW	Low leading PF
THD LOW	Low voltage THD <sup>2,43</sup>
V THD LOW	Low current THD <sup>4</sup>
KF LOW	Low K-Factor <sup>4</sup>
I TDD LOW	Low current TDD <sup>4</sup>
V L-L LOW	Low line-to-line voltage
<b>AVR HIGH</b>	<b>1-Second High Values on any Phase</b>
V HIGH	High line-to-neutral/line-to-line voltage <sup>1</sup>
I HIGH	High current
kW HIGH	High kW
kvar HIGH	High kvar
kVA HIGH	High kVA
PF LAG HIGH	High PF Lag
PF LEAD HIGH	High PF Lead
V THD HIGH	High voltage THD <sup>2,4</sup>
I THD HIGH	High current THD <sup>4</sup>
KF HIGH	High K-Factor <sup>4</sup>
I TDD HIGH	High current TDD <sup>4</sup>
V L-L HIGH	High line-to-line voltage
<b>AVR TOTAL</b>	<b>1-Second Total Values</b>
kW	Total kW
kvar	Total kvar
kVA	Total kVA
PF	Total PF
PF LAG	Total PF lag
PF LEAD	Total PF lead
kW IMP	Total kW import
kW EXP	Total kW export
kvar IMP	Total kvar import
kvar EXP	Total kvar export
V AVG	3-phase average line-to-neutral/line-to-line voltage <sup>1</sup>
V LL AVG	3-phase average line-to-line voltage
I AVG	3-phase average current
kW Fe Loss	Total kW losses due to iron
kW Cu Loss	Total kW losses due to copper
kvar Fe Loss	Total kvar losses due to iron
kvar Cu Loss	Total kvar losses due to copper
<b>AVR AUX</b>	<b>1-Second Auxiliary Values</b>
I4	I4 current
In	In current
FREQ	Frequency

## Appendix A Parameters for Monitoring and Logging

Designation	Description
V UNB%	Voltage unbalance <sup>6</sup>
I UNB%	Current unbalance <sup>6</sup>
VDC	Auxiliary battery voltage
V4x	V4x neutral-ground voltage
Temp	Internal temperature
<b>RMS (0.2 sec)</b>	<b>0.2-Second RMS Values</b>
V1	V1/V12 voltage <sup>1</sup>
V2	V2/V23 voltage <sup>1</sup>
V3	V3/V31 voltage <sup>1</sup>
V12	V12 voltage
V23	V23 voltage
V31	V31 voltage
I1	I1 current
I2	I2 current
I3	I3 current
I4	I4 current
In	In current
V ZERO-SEQ	Zero-sequence voltage
I ZERO-SEQ	Zero-sequence current
V UNB%	Negative-sequence voltage unbalance
I UNB%	Negative-sequence current unbalance
FREQ	Frequency
V PSEQ	Positive-sequence voltage
V ZSEQ UNB%	Zero-sequence voltage unbalance
<b>RMS (3 sec)</b>	<b>3-Second RMS Values</b>
V1	V1/V12 voltage <sup>1</sup>
V2	V2/V23 voltage <sup>1</sup>
V3	V3/V31 voltage <sup>1</sup>
V12	V12 voltage
V23	V23 voltage
V31	V31 voltage
I1	I1 current
I2	I2 current
I3	I3 current
I4	I4 current
In	In current
V ZERO-SEQ	Zero-sequence voltage
I ZERO-SEQ	Zero-sequence current
V UNB%	Negative-sequence voltage unbalance
I UNB%	Negative-sequence current unbalance
FREQ	Frequency <sup>5</sup>
V PSEQ	Positive-sequence voltage
V ZSEQ UNB%	Zero-sequence voltage unbalance
<b>RMS (10 min)</b>	<b>10-Minute RMS Values</b>
V1	V1/V12 voltage <sup>1</sup>
V2	V2/V23 voltage <sup>1</sup>
V3	V3/V31 voltage <sup>1</sup>
V12	V12 voltage
V23	V23 voltage
V31	V31 voltage

Appendix A Parameters for Monitoring and Logging

Designation	Description
I1	I1 current
I2	I2 current
I3	I3 current
I4	I4 current
In	In current
V ZERO-SEQ	Zero-sequence voltage
I ZERO-SEQ	Zero-sequence current
V UNB%	Negative-sequence voltage unbalance
I UNB%	Negative-sequence current unbalance
FREQ	Frequency
V PSEQ	Positive-sequence voltage
V ZSEQ UNB%	Zero-sequence voltage unbalance
<b>HRM TOT (0.2 sec)</b>	<b>0.2-Second Total Harmonics</b>
V1 THD	V1/V12 THD <sup>2</sup>
V2 THD	V2/V23 THD <sup>2</sup>
V3 THD	V3/V31 THD <sup>2</sup>
I1 THD	I1 THD
I2 THD	I2 THD
I3 THD	I3 THD
I4 THD	I4 THD
V1 THD/I	V1/V12 interharmonics THD <sup>2</sup>
V2 THD/I	V2/V23 interharmonics THD <sup>2</sup>
V3 THD/I	V3/V31 interharmonics THD <sup>2</sup>
I1 THD/I	I1 interharmonics THD
I2 THD/I	I2 interharmonics THD
I3 THD/I	I3 interharmonics THD
I4 THD/I	I4 interharmonics THD
I1 TDD	I1 TDD
I2 TDD	I2 TDD
I3 TDD	I3 TDD
I4 TDD	I4 TDD
I1 KF	I1 K-Factor
I2 KF	I2 K-Factor
I3 KF	I3 K-Factor
I4 KF	I4 K-Factor
<b>HRM TOT (3 sec)</b>	<b>3-Second Total Harmonics</b>
V1 THD	V1/V12 THD <sup>2</sup>
V2 THD	V2/V23 THD <sup>2</sup>
V3 THD	V3/V31 THD <sup>2</sup>
I1 THD	I1 THD
I2 THD	I2 THD
I3 THD	I3 THD
I4 THD	I4 THD
V1 THD/I	V1/V12 interharmonics THD <sup>2</sup>
V2 THD/I	V2/V23 interharmonics THD <sup>2</sup>
V3 THD/I	V3/V31 interharmonics THD <sup>2</sup>
I1 THD/I	I1 interharmonics THD
I2 THD/I	I2 interharmonics THD
I3 THD/I	I3 interharmonics THD
I4 THD/I	I4 interharmonics THD

Appendix A Parameters for Monitoring and Logging

Designation	Description
I1 TDD	I1 TDD
I2 TDD	I2 TDD
I3 TDD	I3 TDD
I4 TDD	I4 TDD
I1 KF	I1 K-Factor
I2 KF	I2 K-Factor
I3 KF	I3 K-Factor
I4 KF	I4 K-Factor
<b>HRM TOT (10 min)</b>	<b>10-Minute Total Harmonics</b>
V1 THD	V1/V12 THD <sup>2</sup>
V2 THD	V2/V23 THD <sup>2</sup>
V3 THD	V3/V31 THD <sup>2</sup>
I1 THD	I1 THD
I2 THD	I2 THD
I3 THD	I3 THD
I4 THD	I4 THD
V1 THD/I	V1/V12 interharmonics THD <sup>2</sup>
V2 THD/I	V2/V23 interharmonics THD <sup>2</sup>
V3 THD/I	V3/V31 interharmonics THD <sup>2</sup>
I1 THD/I	I1 interharmonics THD
I2 THD/I	I2 interharmonics THD
I3 THD/I	I3 interharmonics THD
I4 THD/I	I4 interharmonics THD
I1 TDD	I1 TDD
I2 TDD	I2 TDD
I3 TDD	I3 TDD
I4 TDD	I4 TDD
I1 KF	I1 K-Factor
I2 KF	I2 K-Factor
I3 KF	I3 K-Factor
I4 KF	I4 K-Factor
<b>PHASORS</b>	<b>Phasors</b> <sup>3</sup>
V1 Mag	V1/V12 voltage magnitude <sup>2</sup>
V2 Mag	V2/V23 voltage magnitude <sup>2</sup>
V3 Mag	V3/V31 voltage magnitude <sup>2</sup>
I1 Mag	I1 current magnitude
I2 Mag	I2 current magnitude
I3 Mag	I3 current magnitude
I4 Mag	I4 current magnitude
V1 Ang	V1/V12 voltage angle <sup>2</sup>
V2 Ang	V2/V23 voltage angle <sup>2</sup>
V3 Ang	V3/V31 voltage angle <sup>2</sup>
I1 Ang	I1 current angle
I2 Ang	I2 current angle
I3 Ang	I3 current angle
I4 Ang	I4 current angle
<b>DEMANDS</b>	<b>Present Demands</b>
V1 DMD	V1/V12 Volt demand <sup>2</sup>
V2 DMD	V2/V23 Volt demand <sup>2</sup>
V3 DMD	V3/V31 Volt demand <sup>2</sup>

Appendix A Parameters for Monitoring and Logging

Designation	Description
I1 DMD	I1 Ampere demand
I2 DMD	I2 Ampere demand
I3 DMD	I3 Ampere demand
kW IMP BD	kW import block demand
kvar IMP BD	kvar import block demand
kVA BD	kVA block demand
kW IMP SD	kW import sliding window demand
kvar IMP SD	kvar import sliding window demand
kVA SD	kVA sliding window demand
kW IMP ACD	kW import accumulated demand
kvar IMP ACD	kvar import accumulated demand
kVA ACD	kVA accumulated demand
kW IMP PRD	kW import predicted sliding window demand
kvar IMP PRD	kvar import predicted sliding window demand
kVA PRD	kVA predicted sliding window demand
PF IMP@kVA MD	PF (import) at maximum kVA sliding window demand
kW EXP BD	kW export block demand
kvar EXP BD	kvar export block demand
kW EXP SD	kW export sliding window demand
kvar EXP SD	kvar export sliding window demand
kW EXP ACD	kW export accumulated demand
kvar EXP ACD	kvar export accumulated demand
kW EXP PRD	kW export predicted sliding window demand
kvar EXP PRD	kvar export predicted sliding window demand
I4 DMD	I4 Ampere demand
<b>HRM DMD</b>	<b>Present Harmonic Demands</b>
V1 THD DMD	V1/V12 THD demand <sup>2</sup>
V2 THD DMD	V2/V23 THD demand <sup>2</sup>
V3 THD DMD	V3/V31 THD demand <sup>2</sup>
I1 THD DMD	I1 THD demand
I2 THD DMD	I2 THD demand
I3 THD DMD	I3 THD demand
I4 THD DMD	I4 THD demand
I1 TDD DMD	I1 TDD demand
I2 TDD DMD	I2 TDD demand
I3 TDD DMD	I3 TDD demand
I4 TDD DMD	I4 TDD demand
<b>SUMM ACC DMD</b>	<b>Billing Summary (Total) Accumulated Demands</b>
REG1 ACD	Register #1 accumulated demand
REG2 ACD	Register #2 accumulated demand
...	...
REG10 ACD	Register #10 accumulated demand
<b>SUMM BLK DMD</b>	<b>Billing Summary (Total) Block Demands</b>
REG1 BD	Register #1 block demand
REG2 BD	Register #2 block demand
...	...
REG10 BD	Register #10 block demand
<b>SUMM SW DMD</b>	<b>Billing Summary (Total) Sliding Window Demands</b>
REG1 SD	Register #1 sliding demand
REG2 SD	Register #2 sliding demand
...	...

Appendix A Parameters for Monitoring and Logging

Designation	Description
REG10 SD	Register #10 sliding demand
<b>ENERGY</b>	<b>Instrumentation Total Energy</b>
kWh IMPORT	kWh import
kWh EXPORT	kWh export
kWh NET	kWh net
kvarh IMPORT	kvarh import
kvarh EXPORT	kvarh export
kvarh NET	kvarh net
kvarh Q1	kvarh quadrant Q1
kvarh Q2	kvarh quadrant Q2
kvarh Q3	kvarh quadrant Q3
kvarh Q4	kvarh quadrant Q4
kVAh TOTAL	kVAh total
kVAh IMPORT	kVAh import (Q1+Q4)
kVAh EXPORT	kVAh export (Q2+Q3)
<b>SUMMARY REGS</b>	<b>Billing Summary (Total) Energy Registers</b>
SUM REG1	Summary energy register #1
SUM REG2	Summary energy register #2
...	...
SUM REG10	Summary energy register #10
<b>%HD V1</b>	<b>V1/V12 Harmonic Distortions</b> <sup>2,3</sup>
V1 %HD01	H01 Harmonic distortion
V1 %HD02	H02 Harmonic distortion
...	...
V1 %HD50	H50 Harmonic distortion
<b>%HD V2</b>	<b>V2/V23 Harmonic Distortions</b> <sup>2,3</sup>
V2 %HD01	H01 Harmonic distortion
V2 %HD02	H02 Harmonic distortion
...	...
V2 %HD50	H50 Harmonic distortion
<b>%HD V3</b>	<b>V3/V31 Harmonic Distortions</b> <sup>2,3</sup>
V3 %HD01	H01 Harmonic distortion
V3 %HD02	H02 Harmonic distortion
...	...
V3 %HD50	H50 Harmonic distortion
<b>%HD I1</b>	<b>I1 Harmonic Distortions</b> <sup>3</sup>
I1 %HD01	H01 Harmonic distortion
I1 %HD02	H02 Harmonic distortion
...	...
I1 %HD50	H50 Harmonic distortion
<b>%HD I2</b>	<b>I2 Harmonic Distortions</b> <sup>3</sup>
I2 %HD01	H01 Harmonic distortion
I2 %HD02	H02 Harmonic distortion
...	...
I2 %HD50	H50 Harmonic distortion
<b>%HD I3</b>	<b>I3 Harmonic Distortions</b> <sup>3</sup>
I3 %HD01	H01 Harmonic distortion
I3 %HD02	H02 Harmonic distortion
...	...
I3 %HD50	H50 Harmonic distortion



Appendix A Parameters for Monitoring and Logging

Designation	Description
<b>%HD I4</b>	<b>I4 Harmonic Distortions</b> <sup>3</sup>
I3 %HD01	H01 Harmonic distortion
I3 %HD02	H02 Harmonic distortion
...	...
I3 %HD50	H50 Harmonic distortion
<b>ANG V1</b>	<b>V1/V12 Harmonic Angles</b> <sup>2,3</sup>
V1 H01 ANG	H01 Harmonic angle
V1 H02 ANG	H02 Harmonic angle
...	...
V1 H50 ANG	H50 Harmonic angle
<b>ANG V2</b>	<b>V2/V23 Harmonic Angles</b> <sup>2,3</sup>
V2 H01 ANG	H01 Harmonic angle
V2 H02 ANG	H02 Harmonic angle
...	...
V2 H50 ANG	H50 Harmonic angle
<b>ANG V3</b>	<b>V3/V31 Harmonic Angles</b> <sup>2,3</sup>
V3 H01 ANG	H01 Harmonic angle
V3 H02 ANG	H02 Harmonic angle
...	...
V3 H50 ANG	H50 Harmonic angle
<b>ANG I1</b>	<b>I1 Harmonic Angles</b> <sup>3</sup>
I1 H01 ANG	H01 Harmonic angle
I1 H02 ANG	H02 Harmonic angle
...	...
I1 H50 ANG	H50 Harmonic angle
<b>ANG I2</b>	<b>I2 Harmonic Angles</b> <sup>3</sup>
I2 H01 ANG	H01 Harmonic angle
I2 H02 ANG	H02 Harmonic angle
...	...
I2 H50 ANG	H50 Harmonic angle
<b>ANG I3</b>	<b>I3 Harmonic Angles</b> <sup>3</sup>
I3 H01 ANG	H01 Harmonic angle
I3 H02 ANG	H02 Harmonic angle
...	...
I3 H50 ANG	H50 Harmonic angle
<b>ANG I4</b>	<b>I4 Harmonic Angles</b> <sup>3</sup>
I4 H01 ANG	H01 Harmonic angle
I4 H02 ANG	H02 Harmonic angle
...	...
I4 H50 ANG	H50 Harmonic angle
<b>H1 PHASE</b>	<b>Fundamental (H01) Phase Values</b>
V1 H01	V1/V12 voltage <sup>2</sup>
V2 H01	V2/V23 voltage <sup>2</sup>
V3 H01	V3/V31 voltage <sup>2</sup>
I1 H01	I1 Current
I2 H01	I2 Current
I3 H01	I3 Current
kW L1 H01	kW L1 <sup>8</sup>
kW L2 H01	kW L2 <sup>8</sup>
kW L3 H01	kW L3 <sup>8</sup>

Appendix A Parameters for Monitoring and Logging

Designation	Description
kvar L1 H01	kvar L1 <sup>8</sup>
kvar L2 H01	kvar L2 <sup>8</sup>
kvar L3 H01	kvar L3 <sup>8</sup>
kVA L1 H01	kVA L1 <sup>8</sup>
kVA L2 H01	kVA L2 <sup>8</sup>
kVA L3 H01	kVA L3 <sup>8</sup>
PF L1 H01	Power factor L1 <sup>8</sup>
PF L2 H01	Power factor L2 <sup>8</sup>
PF L3 H01	Power factor L3 <sup>8</sup>
<b>HRM TOT POW</b>	<b>Fundamental Total Power Values</b>
kW H01	Total fundamental kW <sup>8</sup>
kvar H01	Total fundamental kvar <sup>8</sup>
kVA H01	Total fundamental kVA <sup>8</sup>
PF H01	Total fundamental PF <sup>8</sup>
<b>FLICKER</b>	<b>Flicker</b>
V1 Pst	V1/V12 short-term (10 min) flicker severity <sup>2</sup>
V2 Pst	V2/V23 short-term (10 min) flicker severity <sup>2</sup>
V3 Pst	V3/V31 short-term (10 min) flicker severity <sup>2</sup>
V1 Pit	V1/V12 long-term (2 hours) flicker severity <sup>2</sup>
V2 Pit	V2/V23 long-term (2 hours) flicker severity <sup>2</sup>
V3 Pit	V3/V31 long-term (2 hours) flicker severity <sup>2</sup>
<b>MIN PHASE</b>	<b>Minimum 1-Cycle Phase Values</b>
V1 MIN	V1/V12 voltage <sup>1</sup>
V2 MIN	V2/V23 voltage <sup>1</sup>
V3 MIN	V3/V31 voltage <sup>1</sup>
I1 MIN	I1 current
I2 MIN	I2 current
I3 MIN	I3 current
kW L1 MIN	kW L1 <sup>8</sup>
kW L2 MIN	kW L2 <sup>8</sup>
kW L3 MIN	kW L3 <sup>8</sup>
kvar L1 MIN	kvar L1 <sup>8</sup>
kvar L2 MIN	kvar L2 <sup>8</sup>
kvar L3 MIN	kvar L3 <sup>8</sup>
kVA L1 MIN	kVA L1 <sup>8</sup>
kVA L2 MIN	kVA L2 <sup>8</sup>
kVA L3 MIN	kVA L3 <sup>8</sup>
PF L1 MIN	Power factor L1 <sup>8</sup>
PF L2 MIN	Power factor L2 <sup>8</sup>
PF L3 MIN	Power factor L3 <sup>8</sup>
V1 THD MIN	V1/V12 voltage THD <sup>2</sup>
V2 THD MIN	V2/V23 voltage THD <sup>2</sup>
V3 THD MIN	V3/V31 voltage THD <sup>2</sup>
I1 THD MIN	I1 current THD
I2 THD MIN	I2 current THD
I3 THD MIN	I3 current THD
I1 KF MIN	I1 K-Factor
I2 KF MIN	I2 K-Factor

Appendix A Parameters for Monitoring and Logging

Designation	Description
I3 KF MIN	I3 K-Factor
I1 TDD MIN	I1 current TDD
I2 TDD MIN	I2 current TDD
I3 TDD MIN	I3 current TDD
V12 MIN	V12 voltage
V23 MIN	V23 voltage
V31 MIN	V31 voltage
<b>MIN TOTAL</b>	<b>Minimum 1-Cycle Total Values</b>
kW MIN	Total kW <sup>8</sup>
kvar MIN	Total kvar <sup>8</sup>
kVA MIN	Total kVA <sup>8</sup>
PF MIN	Total PF <sup>8</sup>
PF LAG MIN	Total PF lag <sup>8</sup>
PF LEAD MIN	Total PF lead <sup>8</sup>
<b>MIN AUX</b>	<b>Minimum 1-Cycle Auxiliary Values</b>
I4 MIN	I4 current
In MIN	In current
FREQ MIN	Frequency
V UNB% MIN	Voltage unbalance <sup>6</sup>
I UNB% MIN	Current unbalance <sup>6</sup>
<b>MAX PHASE</b>	<b>Maximum 1-Cycle Phase Values</b>
V1 MAX	V1/V12 voltage <sup>1</sup>
V2 MAX	V2/V23 voltage <sup>1</sup>
V3 MAX	V3/V31 voltage <sup>1</sup>
I1 MAX	I1 current
I2 MAX	I2 current
I3 MAX	I3 current
kW L1 MAX	kW L1 <sup>8</sup>
kW L2 MAX	kW L2 <sup>8</sup>
kW L3 MAX	kW L3 <sup>8</sup>
kvar L1 MAX	kvar L1 <sup>8</sup>
kvar L2 MAX	kvar L2 <sup>8</sup>
kvar L3 MAX	kvar L3 <sup>8</sup>
kVA L1 MAX	kVA L1 <sup>8</sup>
kVA L2 MAX	kVA L2 <sup>8</sup>
kVA L3 MAX	kVA L3 <sup>8</sup>
PF L1 MAX	Power factor L1 <sup>8</sup>
PF L2 MAX	Power factor L2 <sup>8</sup>
PF L3 MAX	Power factor L3 <sup>8</sup>
V1 THD MAX	V1/V12 voltage THD <sup>2</sup>
V2 THD MAX	V2/V23 voltage THD <sup>2</sup>
V3 THD MAX	V3/V31 voltage THD <sup>2</sup>
I1 THD MAX	I1 current THD
I2 THD MAX	I2 current THD
I3 THD MAX	I3 current THD
I1 KF MAX	I1 K-Factor
I2 KF MAX	I2 K-Factor
I3 KF MAX	I3 K-Factor
I1 TDD MAX	I1 current TDD

Appendix A Parameters for Monitoring and Logging

Designation	Description
I2 TDD MAX	I2 current TDD
I3 TDD MAX	I3 current TDD
V12 MAX	V12 voltage
V23 MAX	V23 voltage
V31 MAX	V31 voltage
<b>MAX TOTAL</b>	<b>Maximum 1-Cycle Total Values</b>
kW MAX	Total kW <sup>8</sup>
kvar MAX	Total kvar <sup>8</sup>
kVA MAX	Total kVA <sup>8</sup>
PF MAX	Total PF <sup>8</sup>
PF LAG MAX	Total PF lag <sup>8</sup>
PF LEAD MAX	Total PF lead <sup>8</sup>
<b>MAX AUX</b>	<b>Maximum 1-Cycle Auxiliary Values</b>
I4 MAX	I4 current
In MAX	In current
FREQ MAX	Frequency
V UNB% MAX	Voltage unbalance <sup>6</sup>
I UNB% MAX	Current unbalance <sup>6</sup>
<b>MAX DMD</b>	<b>Instrumentation Maximum Demands</b>
V1 DMD MAX	V1/V12 maximum volt demand <sup>2</sup>
V2 DMD MAX	V2/V23 maximum volt demand <sup>2</sup>
V3 DMD MAX	V3/V31 maximum volt demand <sup>2</sup>
I1 DMD MAX	I1 maximum ampere demand
I2 DMD MAX	I2 maximum ampere demand
I3 DMD MAX	I3 maximum ampere demand
kW IMP SD MAX	Maximum kW import sliding demand
kvar IMP SD MAX	Maximum kvar import sliding demand
kVA SD MAX	Maximum kVA sliding demand
kvar EXP SD MAX	Maximum kW export sliding demand
kvar EXP SD MAX	Maximum kvar export sliding demand
I4 DMD MAX	I4 maximum ampere demand
<b>MAX HRM DMD</b>	<b>Maximum Harmonic Demands</b>
V1 THD DMD MAX	V1/V12 THD demand <sup>2</sup>
V2 THD DMD MAX	V2/V23 THD demand <sup>2</sup>
V3 THD DMD MAX	V3/V31 THD demand <sup>2</sup>
I1 THD DMD MAX	I1 THD demand
I2 THD DMD MAX	I2 THD demand
I3 THD DMD MAX	I3 THD demand
I4 THD DMD MAX	I4 THD demand
I1 TDD DMD MAX	I1 TDD demand
I2 TDD DMD MAX	I2 TDD demand
I3 TDD DMD MAX	I3 TDD demand
I4 TDD DMD MAX	I4 TDD demand
<b>MAX SUMMARY DMD</b>	<b>Billing Summary (Total) Maximum Demands</b>
REG1 MD	Summary register #1 maximum demand
REG2 MD	Summary register #2 maximum demand
...	...
REG10 MD	Summary register #10 maximum demand
REG1 CMD	Summary register #1 cumulative maximum demand
REG2 CMD	Summary register #2 cumulative maximum demand

Appendix A Parameters for Monitoring and Logging

Designation	Description
...	...
REG10 CMD	Summary register #10 cumulative maximum demand
<b>TOU PRMS</b>	<b>TOU Parameters</b>
ACTIVE TARIFF	Active TOU tariff
ACTIVE PROFILE	Active TOU profile
<b>TOU REG1</b>	<b>Billing TOU Energy Register #1</b>
REG1 TRF1	Tariff #1 register
REG1 TRF2	Tariff #2 register
...	...
REG1 TRF8	Tariff #8 register
<b>TOU REG2</b>	<b>Billing TOU Energy Register #2</b>
REG2 TRF1	Tariff #1 register
REG2 TRF2	Tariff #2 register
...	...
REG2 TRF8	Tariff #8 register
<b>TOU REG3</b>	<b>Billing TOU Energy Register #3</b>
REG3 TRF1	Tariff #1 register
REG3 TRF2	Tariff #2 register
...	...
REG3 TRF8	Tariff #8 register
<b>TOU REG4</b>	<b>Billing TOU Energy Register #4</b>
REG4 TRF1	Tariff #1 register
REG4 TRF2	Tariff #2 register
...	...
REG4 TRF8	Tariff #8 register
<b>TOU REG5</b>	<b>Billing TOU Energy Register #5</b>
REG5 TRF1	Tariff #1 register
REG5 TRF2	Tariff #2 register
...	...
REG5 TRF8	Tariff #8 register
<b>TOU REG6</b>	<b>Billing TOU Energy Register #6</b>
REG6 TRF1	Tariff #1 register
REG6 TRF2	Tariff #2 register
...	...
REG6 TRF8	Tariff #8 register
<b>TOU REG7</b>	<b>Billing TOU Energy Register #7</b>
REG7 TRF1	Tariff #1 register
REG7 TRF2	Tariff #2 register
...	...
REG7 TRF8	Tariff #8 register
<b>TOU REG8</b>	<b>Billing TOU Energy Register #8</b>
REG8 TRF1	Tariff #1 register
REG8 TRF2	Tariff #2 register
...	...
REG8 TRF8	Tariff #8 register
<b>TOU REG9</b>	<b>Billing TOU Energy Register #9</b>
REG9 TRF1	Tariff #1 register
REG9 TRF2	Tariff #2 register
...	...
REG9 TRF8	Tariff #8 register

Appendix A Parameters for Monitoring and Logging

Designation	Description
<b>TOU REG10</b>	<b>Billing TOU Energy Register #10</b>
REG10 TRF1	Tariff #1 register
REG10 TRF2	Tariff #2 register
...	...
REG10 TRF8	Tariff #8 register
<b>TOU MAX DMD REG1</b>	<b>Billing TOU Maximum Demand Register #1</b>
REG1 TRF1 MD	Tariff #1 maximum demand
REG1 TRF2 MD	Tariff #2 maximum demand
...	...
REG1 TRF8 MD	Tariff #8 maximum demand
REG1 TRF1 CMD	Tariff #1 cumulative maximum demand
REG1 TRF2 CMD	Tariff #2 cumulative maximum demand
...	...
REG1 TRF8 CMD	Tariff #8 cumulative maximum demand
<b>TOU MAX DMD REG2</b>	<b>Billing TOU Maximum Demand Register #2</b>
REG2 TRF1 MD	Tariff #1 maximum demand
REG2 TRF2 MD	Tariff #2 maximum demand
...	...
REG2 TRF8 MD	Tariff #8 maximum demand
REG2 TRF1 CMD	Tariff #1 cumulative maximum demand
REG2 TRF2 CMD	Tariff #2 cumulative maximum demand
...	...
REG2 TRF8 CMD	Tariff #8 cumulative maximum demand
<b>TOU MAX DMD REG3</b>	<b>Billing TOU Maximum Demand Register #3</b>
REG3 TRF1 MD	Tariff #1 maximum demand
REG3 TRF2 MD	Tariff #2 maximum demand
...	...
REG3 TRF8 MD	Tariff #8 maximum demand
REG3 TRF1 CMD	Tariff #1 cumulative maximum demand
REG3 TRF2 CMD	Tariff #2 cumulative maximum demand
...	...
REG3 TRF8 CMD	Tariff #8 cumulative maximum demand
<b>TOU MAX DMD REG4</b>	<b>Billing TOU Maximum Demand Register #4</b>
REG4 TRF1 MD	Tariff #1 maximum demand
REG4 TRF2 MD	Tariff #2 maximum demand
...	...
REG4 TRF8 MD	Tariff #8 maximum demand
REG4 TRF1 CMD	Tariff #1 cumulative maximum demand
REG4 TRF2 CMD	Tariff #2 cumulative maximum demand
...	...
REG4 TRF8 CMD	Tariff #8 cumulative maximum demand
<b>TOU MAX DMD REG5</b>	<b>Billing TOU Maximum Demand Register #5</b>
REG5 TRF1 MD	Tariff #1 maximum demand
REG5 TRF2 MD	Tariff #2 maximum demand
...	...
REG5 TRF8 MD	Tariff #8 maximum demand
REG5 TRF1 CMD	Tariff #1 cumulative maximum demand
REG5 TRF2 CMD	Tariff #2 cumulative maximum demand
...	...
REG5 TRF8 CMD	Tariff #8 cumulative maximum demand

Appendix A Parameters for Monitoring and Logging

Designation	Description
<b>TOU MAX DMD REG6</b>	<b>Billing TOU Maximum Demand Register #6</b>
REG6 TRF1 MD	Tariff #1 maximum demand
REG6 TRF2 MD	Tariff #2 maximum demand
...	...
REG6 TRF8 MD	Tariff #8 maximum demand
REG6 TRF1 CMD	Tariff #1 cumulative maximum demand
REG6 TRF2 CMD	Tariff #2 cumulative maximum demand
...	...
REG6 TRF8 CMD	Tariff #8 cumulative maximum demand
<b>TOU MAX DMD REG7</b>	<b>Billing TOU Maximum Demand Register #7</b>
REG7 TRF1 MD	Tariff #1 maximum demand
REG7 TRF2 MD	Tariff #2 maximum demand
...	...
REG7 TRF8 MD	Tariff #8 maximum demand
REG7 TRF1 CMD	Tariff #1 cumulative maximum demand
REG7 TRF2 CMD	Tariff #2 cumulative maximum demand
...	...
REG7 TRF8 CMD	Tariff #8 cumulative maximum demand
<b>TOU MAX DMD REG8</b>	<b>Billing TOU Maximum Demand Register #8</b>
REG8 TRF1 MD	Tariff #1 maximum demand
REG8 TRF2 MD	Tariff #2 maximum demand
...	...
REG8 TRF8 MD	Tariff #8 maximum demand
REG8 TRF1 CMD	Tariff #1 cumulative maximum demand
REG8 TRF2 CMD	Tariff #2 cumulative maximum demand
...	...
REG8 TRF8 CMD	Tariff #8 cumulative maximum demand
<b>TOU MAX DMD REG9</b>	<b>Billing TOU Maximum Demand Register #9</b>
REG9 TRF1 MD	Tariff #1 maximum demand
REG9 TRF2 MD	Tariff #2 maximum demand
...	...
REG9 TRF8 MD	Tariff #8 maximum demand
REG9 TRF1 CMD	Tariff #1 cumulative maximum demand
REG9 TRF2 CMD	Tariff #2 cumulative maximum demand
...	...
REG9 TRF8 CMD	Tariff #8 cumulative maximum demand
<b>TOU MAX DMD REG10</b>	<b>Billing TOU Maximum Demand Register #10</b>
REG10 TRF1 MD	Tariff #1 maximum demand
REG10 TRF2 MD	Tariff #2 maximum demand
...	...
REG10 TRF8 MD	Tariff #8 maximum demand
REG10 TRF1 CMD	Tariff #1 cumulative maximum demand
REG10 TRF2 CMD	Tariff #2 cumulative maximum demand
...	...
REG10 TRF8 CMD	Tariff #8 cumulative maximum demand
<b>Present PQ Values</b>	<b>Present Measured EN50160 Parameters</b>
V1 Var%	V1 Voltage variation, +/-%Un (last 10-min value)
V2 Var%	V2 Voltage variation, +/-%Un (last 10-min value)
V3 Var%	V3 Voltage variation, +/-%Un (last 10-min value)
V1 Chg%	V1 Voltage change, %Un (last 1-hour value)
V1 Chg Freq	Repetition rate of V1 voltage changes, 1/min

Designation	Description
V2 Chg%	V2 Voltage change, %Un (last 1-hour value)
V2 Chg Freq	Repetition rate of V2 voltage changes, 1/min
V3 Chg%	V3 Voltage change, %Un (last 1-hour value)
V3 Chg Freq	Repetition rate of V3 voltage changes, 1/min
V1 Pst	V1 Voltage Pst
V2 Pst	V2 Voltage Pst
V3 Pst	V3 Voltage Pst
V1 Plt	V1 Voltage Plt
V2 Plt	V2 Voltage Plt
V3 Plt	V3 Voltage Plt
V1 THD	V1 Voltage THD, %
V2 THD	V2 Voltage THD, %
V3 THD	V3 Voltage THD, %
NSeq Unb%	Negative-sequence voltage unbalance, % (last 10-min value)
Freq Var	Frequency variation, +/-Hz (last 10-s value)

<sup>1</sup> In 4LN3, 4LL3, 3LN3 and 3LL3 wiring modes, the voltages are line-to-neutral; for any other wiring mode, they are line-to-line voltages.

<sup>2</sup> In 4LN3 and 3LN3 wiring modes, the voltages are line-to-neutral; for any other wiring mode, they are line-to-line voltages.

<sup>3</sup> On a 0.2-s interval.

<sup>4</sup> On a 3-s interval.

<sup>5</sup> On a 10-s interval.

<sup>6</sup> The value is calculated using a simplified technique as a relation of the maximum deviation of phase values from a 3-phase average value to a 3-phase average.

<sup>7</sup> The value is calculated using a simplified technique as a one third of the RMS value of a 3-phase vector sum.

<sup>8</sup> Not affected by loss compensation – always indicate readings at the metering point.

**NOTE**

Designations of some engineering demands and billing energy and demand registers are shown using a new short name notation available in PAS V1.4. By default, PAS uses long names compatible with older versions of PAS. You can select a desired notation from the Tools/Options/Preferences tab.

PAS does not allow to store data in files using different data names. If you have a file uploaded with a previous version of PAS using long data names, either continue using long data names, or store data in a new file.

See table below for a list of parameters with short and long names.

Short Data Name	Long Data Name	Description
kW IMP ACD	kW IMP ACC DMD	Accumulated demand
kW IMP PRD	kW IMP PRD DMD	Predicted sliding window demand
PF IMP@kVA MD	PF IMP@kVA MXDMD	PF (import) at maximum kVA demand
REG1 ACD	SUM REG1 ACC DMD	Billing summary (total) register accumulated demand



Appendix A Parameters for Monitoring and Logging

---

<b>Short Data Name</b>	<b>Long Data Name</b>	<b>Description</b>
REG1 BD	SUM REG1 BLK DMD	Billing summary (total) register block demand
REG1 SD	SUM REG1 SW DMD	Billing summary (total) register sliding demand
REG1	SUM REG1	Billing summary (total) energy register
REG1 MD	SUM REG1 DMD MAX	Billing summary (total) register maximum demand
REG1 TRF1	TOU REG1 TRF1	Billing tariff energy register
REG1 TRF1 MD	DMD1 TRF1 MAX	Billing tariff register maximum demand
TRF1	SEASON TRF1	Generic billing tariff energy register
TRF1 MD	SEASON TRF1	Generic billing tariff register maximum demand

## Appendix B Setpoint Parameters

### Setpoint Triggers

For setpoint triggers, see Appendix A Parameters for Monitoring and Logging.

### Setpoint Actions

The available setpoint actions are listed in the following table.

#### Setpoint Actions

Action	Target	Description
NONE		No action
SET EVENT FLAG	1-8	Set user event flag 1-8
CLEAR EVENT FLAG	1-8	Clear user event flag 1-8
OPERATE RELAY	1-4	Operate relay RO1-RO4
RELEASE RELAY	1-4	Release latched relay RO1-RO4
INCREMENT COUNTER	1-8	Increment counter 1-8
CLEAR COUNTER	1-8	Clear counter 1-8
RESET ALL COUNTERS		Clear all counters
RESET DEMANDS	ALL	Reset all engineering maximum demands
RESET DEMANDS	POWER	Reset engineering maximum power demands
RESET DEMANDS	VOLT/AMP	Reset maximum volts and ampere demand
RESET DEMANDS	VOLT	Reset maximum volt demand registers
RESET DEMANDS	AMP	Reset maximum ampere demand registers
RESET DEMANDS	HRM	Reset maximum harmonic demand registers
RESET TOU DEMANDS		Reset billing/TOU maximum demands (end of billing period)
CLEAR MIN/MAX LOG		Clear Min/Max log
EVENT LOG	OPER	Event log on setpoint operated
EVENT LOG	RELS	Event log on setpoint released
EVENT LOG	ANY	Event log on any setpoint transition
DATA LOG	1-14	Conventional data log 1-14
WAVEFORM LOG	1-2	Waveform Log 1-2
SEND NOTIFICATION		Send a notification message to a remote TCP server

## Appendix C Billing and Load Profile Log Files

The following tables show the record structure for the monthly and daily billing data profile and energy load profile log files.

The second column shows data abbreviations used in the PAS data log reports. Data log file sections are highlighted in bold.

**Energy Load Profile Data Log (Data Log #12)**

Field No.	Designation	Description
1	REG1	Summary (total) energy register 1 reading
2	REG2	Summary (total) energy register 2 reading
3	REG3	Summary (total) energy register 3 reading
4	REG4	Summary (total) energy register 4 reading
5	REG5	Summary (total) energy register 5 reading
6	REG6	Summary (total) energy register 6 reading
7	REG7	Summary (total) energy register 7 reading
8	REG8	Summary (total) energy register 8 reading
9	REG9	Summary (total) energy register 9 reading
10	REG10	Summary (total) energy register 10 reading

The number of parameters in a record is automatically configured depending on the number of billing registers for which you selected a source input in the Billing/TOU Register setup.

**Montly Billing Profile (Billing Period) Data Log (Data Log #15)**

Field No.	Designation	Description
<b>Energy Register #1</b>		
1	REG1	Summary (total) energy reading
2	TRF1	Tariff #1 energy reading
3	TRF2	Tariff #2 energy reading
4	TRF3	Tariff #3 energy reading
5	TRF4	Tariff #4 energy reading
6	TRF5	Tariff #5 energy reading
7	TRF6	Tariff #6 energy reading
8	TRF7	Tariff #7 energy reading
9	TRF8	Tariff #8 energy reading
...		
<b>Energy Register #10</b>		
1	REG10	Summary (total) energy reading
2	TRF1	Tariff #1 energy reading
3	TRF2	Tariff #2 energy reading
4	TRF3	Tariff #3 energy reading
5	TRF4	Tariff #4 energy reading
6	TRF5	Tariff #5 energy reading
7	TRF6	Tariff #6 energy reading
8	TRF7	Tariff #7 energy reading
9	TRF8	Tariff #8 energy reading
<b>Monthly Maximum Demand Register #1</b>		
1	REG1 MD	Summary (total) max. demand

Appendix C Billing and Load Profile Log Files

Field No.	Designation	Description
2	TIME0	Summary (total) max. demand timestamp
3	REG1 CMD	Summary (total) cumulative max. demand
4	TRF1 MD	Tariff #1 max. demand
5	TIME1	Tariff #1 max. demand timestamp
6	TRF1 CMD	Tariff #1 cumulative max. demand
7	TRF2 MD	Tariff #2 max. demand
8	TIME2	Tariff #2 max. demand timestamp
9	TRF2 CMD	Tariff #2 cumulative max. demand
10	TRF3 MD	Tariff #3 max. demand
11	TIME3	Tariff #3 max. demand timestamp
12	TRF3 CMD	Tariff #3 cumulative max. demand
13	TRF4 MD	Tariff #4 max. demand
14	TIME4	Tariff #4 max. demand timestamp
15	TRF4 CMD	Tariff #4 cumulative max. demand
16	TRF5 MD	Tariff #5 max. demand
17	TIME5	Tariff #5 max. demand timestamp
18	TRF5 CMD	Tariff #5 cumulative max. demand
19	TRF6 MD	Tariff #6 max. demand
20	TIME6	Tariff #6 max. demand timestamp
21	TRF6 CMD	Tariff #6 cumulative max. demand
22	TRF7 MD	Tariff #7 max. demand
23	TIME7	Tariff #7 max. demand timestamp
24	TRF7 CMD	Tariff #7 cumulative max. demand
25	TRF8 MD	Tariff #8 max. demand
26	TIME8	Tariff #8 max. demand timestamp
27	TRF8 CMD	Tariff #8 cumulative max. demand
		...
		<b>Monthly Maximum Demand Register #10</b>
1	REG10 MD	Summary (total) max. demand
2	TIME0	Summary (total) max. demand timestamp
3	REG10 CMD	Summary (total) cumulative max. demand
4	TRF1 MD	Tariff #1 max. demand
5	TIME1	Tariff #1 max. demand timestamp
6	TRF1 CMD	Tariff #1 cumulative max. demand
7	TRF2 MD	Tariff #2 max. demand
8	TIME2	Tariff #2 max. demand timestamp
9	TRF2 CMD	Tariff #2 cumulative max. demand
10	TRF3 MD	Tariff #3 max. demand
11	TIME3	Tariff #3 max. demand timestamp
12	TRF3 CMD	Tariff #3 cumulative max. demand
13	TRF4 MD	Tariff #4 max. demand
14	TIME4	Tariff #4 max. demand timestamp
15	TRF4 CMD	Tariff #4 cumulative max. demand
16	TRF5 MD	Tariff #5 max. demand
17	TIME5	Tariff #5 max. demand timestamp
18	TRF5 CMD	Tariff #5 cumulative max. demand
19	TRF6 MD	Tariff #6 max. demand
20	TIME6	Tariff #6 max. demand timestamp
21	TRF6 CMD	Tariff #6 cumulative max. demand
22	TRF7 MD	Tariff #7 max. demand
23	TIME7	Tariff #7 max. demand timestamp

Field No.	Designation	Description
24	TRF7 CMD	Tariff #7 cumulative max. demand
25	TRF8 MD	Tariff #8 max. demand
26	TIME8	Tariff #8 max. demand timestamp
27	TRF8 CMD	Tariff #8 cumulative max. demand

The number of parameters in each section is automatically configured depending on the number of actual tariffs you defined in the TOU Daily Profiles

**Daily Billing Profile Data Log (Data Log #16)**

Field No.	Designation	Description
<b>Energy Register #1</b>		
1	REG1	Summary (total) energy reading
2	TRF1	Tariff #1 energy reading
3	TRF2	Tariff #2 energy reading
4	TRF3	Tariff #3 energy reading
5	TRF4	Tariff #4 energy reading
6	TRF5	Tariff #5 energy reading
7	TRF6	Tariff #6 energy reading
8	TRF7	Tariff #7 energy reading
9	TRF8	Tariff #8 energy reading
...		
<b>Energy Register #10</b>		
1	REG10	Summary (total) energy reading
2	TRF1	Tariff #1 energy reading
3	TRF2	Tariff #2 energy reading
4	TRF3	Tariff #3 energy reading
5	TRF4	Tariff #4 energy reading
6	TRF5	Tariff #5 energy reading
7	TRF6	Tariff #6 energy reading
8	TRF7	Tariff #7 energy reading
9	TRF8	Tariff #8 energy reading
<b>Daily Maximum Demand Register #1</b>		
1	REG1 MD	Summary (total) max. demand reading
2	TRF1 MD	Tariff #1 max. demand reading
3	TRF2 MD	Tariff #2 max. demand reading
4	TRF3 MD	Tariff #3 max. demand reading
5	TRF4 MD	Tariff #4 max. demand reading
6	TRF5 MD	Tariff #5 max. demand reading
7	TRF6 MD	Tariff #6 max. demand reading
8	TRF7 MD	Tariff #7 max. demand reading
9	TRF8 MD	Tariff #8 max. demand reading
...		
<b>Daily Maximum Demand Register #10</b>		
1	REG10 MD	Summary (total) max. demand reading
2	TRF1 MD	Tariff #1 max. demand reading
3	TRF2 MD	Tariff #2 max. demand reading
4	TRF3 MD	Tariff #3 max. demand reading
5	TRF4 MD	Tariff #4 max. demand reading
6	TRF5 MD	Tariff #5 max. demand reading
7	TRF6 MD	Tariff #6 max. demand reading

## Appendix C Billing and Load Profile Log Files

---

<b>Field No.</b>	<b>Designation</b>	<b>Description</b>
8	TRF7 MD	Tariff #7 max. demand reading
9	TRF8 MD	Tariff #8 max. demand reading

The number of parameters in each section is automatically configured depending on the number of actual tariffs you defined in the TOU Daily Profiles.

## Appendix D EN50160 Statistics Log Files

The following tables list the EN50160 evaluation parameters recorded by the device to the EN50160 statistics data log files. The second column shows data abbreviations used in the PAS data log reports. Data log file sections are highlighted in bold.

**EN50160 Compliance Statistics Log (Data Log #9)**

Field No.	Designation	Description
<b>Power Frequency</b>		
1	Nnv	Number of non-valid 10-sec intervals
2	N	Number of valid 10-sec intervals
3	N1	Number of incidents $\pm 1\%$ , N1
4	N2	Number of incidents $+4\%/-6\%$ , N2
5	N1/N, %	EN50160 compliance ratio, N1/N
6	N2/N, %	EN50160 compliance ratio, N2/N
7	Freq Min	Minimum frequency
8	Freq Max	Maximum frequency
<b>Supply Voltage Variations</b>		
1	Nnv	Number of non-valid 10-min intervals
2	N	Number of valid 10-min intervals
3	N1	Number of polyphase incidents $\pm 10\%$ , N1
4	N2	Number of polyphase incidents $+10/-15\%$ , N2
5	N1/N, %	EN50160 compliance ratio, N1/N
6	N2/N, %	EN50160 compliance ratio, N2/N
7	V1 N1	Number of incidents $\pm 10\%$ on phase V1
8	V1 Min	Minimum voltage on phase V1
9	V1 Max	Maximum voltage on phase V1
10	V2 N1	Number of incidents $\pm 10\%$ on phase V2
11	V2 Min	Minimum voltage on phase V2
12	V2 Max	Maximum voltage on phase V2
13	V3 N1	Number of incidents $\pm 10\%$ on phase V3
14	V3 Min	Minimum voltage on phase V3
15	V3 Max	Maximum voltage on phase V3
<b>Rapid Voltage Changes</b>		
1	N1	Number of polyphase incidents
2	V1 N1	Number of incidents on phase V1
3	V1 dV%	Maximum voltage variation on phase V1, $dV/Un\%$
4	V2 N1	Number of incidents on phase V2
5	V2 dV%	Maximum voltage variation on phase V2, $dV/Un\%$
6	V3 N1	Number of incidents on phase V3
7	V3 dV%	Maximum voltage variation on phase V3, $dV/Un\%$
<b>Flicker</b>		
1	Nnv	Number of non-valid 2-hour intervals
2	N	Number of valid 2-hour intervals
3	N1	Number of polyphase incidents $Plt > 1\%$ , N1
4	N1/N, %	EN50160 compliance ratio, N1/N
5	V1 N1	Number of incidents $Plt > 1\%$ on phase V1
6	V1 Plt Max	Maximum Plt on phase V2
7	V2 N1	Number of incidents $Plt > 1\%$ on phase V2

Field No.	Designation	Description
8	V2 Plt Max	Maximum Plt on phase V2
9	V3 N1	Number of incidents Plt > 1% on phase V3
10	V3 Plt Max	Maximum Plt on phase V3
		<b>Voltage Dips (indicative statistics)</b>
1	N11 90%/100ms	Number of polyphase incidents $u < 90\%/t < 100\text{ms}$
2	N12 85%/100ms	Number of polyphase incidents $u < 85\%/t < 100\text{ms}$
3	N13 70%/100ms	Number of polyphase incidents $u < 70\%/t < 100\text{ms}$
4	N14 40%/100ms	Number of polyphase incidents $u < 40\%/t < 100\text{ms}$
5	N11 90%/500ms	Number of polyphase incidents $u < 90\%/t < 500\text{ms}$
6	N12 85%/500ms	Number of polyphase incidents $u < 85\%/t < 500\text{ms}$
7	N13 70%/500ms	Number of polyphase incidents $u < 70\%/t < 500\text{ms}$
8	N14 40%/500ms	Number of polyphase incidents $u < 40\%/t < 500\text{ms}$
9	N11 90%/1s	Number of polyphase incidents $u < 90\%/t < 1\text{s}$
10	N12 85%/1s	Number of polyphase incidents $u < 85\%/t < 1\text{s}$
11	N13 70%/1s	Number of polyphase incidents $u < 70\%/t < 1\text{s}$
12	N14 40%/1s	Number of polyphase incidents $u < 40\%/t < 1\text{s}$
13	N11 90%/3s	Number of polyphase incidents $u < 90\%/t < 3\text{s}$
14	N12 85%/3s	Number of polyphase incidents $u < 85\%/t < 3\text{s}$
15	N13 70%/3s	Number of polyphase incidents $u < 70\%/t < 3\text{s}$
16	N14 40%/3s	Number of polyphase incidents $u < 40\%/t < 3\text{s}$
17	N11 90%/20s	Number of polyphase incidents $u < 90\%/t < 20\text{s}$
18	N12 85%/20s	Number of polyphase incidents $u < 85\%/t < 20\text{s}$
19	N13 70%/20s	Number of polyphase incidents $u < 70\%/t < 20\text{s}$
20	N14 40%/20s	Number of polyphase incidents $u < 40\%/t < 20\text{s}$
21	N11 90%/60s	Number of polyphase incidents $u < 90\%/t < 60\text{s}$
22	N12 85%/60s	Number of polyphase incidents $u < 85\%/t < 60\text{s}$
23	N13 70%/60s	Number of polyphase incidents $u < 70\%/t < 60\text{s}$
24	N14 40%/60s	Number of polyphase incidents $u < 40\%/t < 60\text{s}$
25	N11 90%/180s	Number of polyphase incidents $u < 90\%/t < 180\text{s}$
26	N12 85%/180s	Number of polyphase incidents $u < 85\%/t < 180\text{s}$
27	N13 70%/180s	Number of polyphase incidents $u < 70\%/t < 180\text{s}$
28	N14 40%/180s	Number of polyphase incidents $u < 40\%/t < 180\text{s}$
29	V1 N1	Total number of incidents on phase V1
30	V1 Min	Minimum residual voltage on phase V1
31	V2 N1	Total number of incidents on phase V2
32	V2 Min	Minimum residual voltage on phase V2
33	V3 N1	Total number of incidents on phase V3
34	V3 Min	Minimum residual voltage on phase V3
		<b>Voltage Interruptions (indicative statistics)</b>
1	N1 1s	Number of polyphase incidents $t < 1\text{s}$
2	N2 180s	Number of polyphase incidents $t < 180\text{s}$
3	N3 >180s	Number of polyphase incidents $t > 180\text{s}$
4	V1 Min	Minimum residual voltage on phase V1
5	V2 Min	Minimum residual voltage on phase V2
6	V3 Min	Minimum residual voltage on phase V3
		<b>Temporary Overvoltages (indicative statistics)</b>
1	N11 110%/1s	Number of polyphase incidents $u > 110\%/t < 1\text{s}$
2	N12 120%/1s	Number of polyphase incidents $u > 120\%/t < 1\text{s}$
3	N13 140%/1s	Number of polyphase incidents $u > 140\%/t < 1\text{s}$
4	N14 160%/1s	Number of polyphase incidents $u > 160\%/t < 1\text{s}$
5	N15 200%/1s	Number of polyphase incidents $u > 200\%/t < 1\text{s}$



Field No.	Designation	Description
6	N21 110%/60s	Number of polyphase incidents $u > 110\%/t < 60s$
7	N22 120%/60s	Number of polyphase incidents $u > 120\%/t < 60s$
8	N23 140%/60s	Number of polyphase incidents $u > 140\%/t < 60s$
9	N24 160%/60s	Number of polyphase incidents $u > 160\%/t < 60s$
10	N25 200%/60s	Number of polyphase incidents $u > 200\%/t < 60s$
11	N31 110%/>60s	Number of polyphase incidents $u > 110\%/t > 60s$
12	N32 120%/>60s	Number of polyphase incidents $u > 120\%/t > 60s$
13	N33 140%/>60s	Number of polyphase incidents $u > 140\%/t > 60s$
14	N34 160%/>60s	Number of polyphase incidents $u > 160\%/t > 60s$
15	N35 200%/>60s	Number of polyphase incidents $u > 200\%/t > 60s$
16	V1 N1	Total number of incidents on phase V1
17	V1 Max	Maximum voltage magnitude on phase V1
18	V2 N1	Total number of incidents on phase V2
19	V2 Max	Maximum voltage magnitude on phase V2
20	V3 N1	Total number of incidents on phase V3
21	V3 Max	Maximum voltage magnitude on phase V3
		<b>Transient Overvoltages (peak voltage)</b>
1	N1 120%	Number of polyphase incidents $u > 120\%$
2	N2 150%	Number of polyphase incidents $u > 150\%$
3	N3 200%	Number of polyphase incidents $u > 200\%$
4	N4 250%	Number of polyphase incidents $u > 250\%$
5	N5 300%	Number of polyphase incidents $u > 300\%$
6	V1 N1 120%	Number of incidents $u > 120\%$ on phase V1
7	V1 N2 150%	Number of incidents $u > 150\%$ on phase V1
8	V1 N3 200%	Number of incidents $u > 200\%$ on phase V1
9	V1 N4 250%	Number of incidents $u > 250\%$ on phase V1
10	V1 N5 300%	Number of incidents $u > 300\%$ on phase V1
11	V2 N1 110%	Number of incidents $u > 120\%$ on phase V2
12	V2 N2 150%	Number of incidents $u > 150\%$ on phase V2
13	V2 N3 200%	Number of incidents $u > 200\%$ on phase V2
14	V2 N4 250%	Number of incidents $u > 250\%$ on phase V2
15	V2 N5 300%	Number of incidents $u > 300\%$ on phase V2
16	V3 N1 110%	Number of incidents $u > 120\%$ on phase V3
17	V3 N2 150%	Number of incidents $u > 150\%$ on phase V3
18	V3 N3 200%	Number of incidents $u > 200\%$ on phase V3
19	V3 N4 250%	Number of incidents $u > 250\%$ on phase V3
20	V3 N5 300%	Number of incidents $u > 300\%$ on phase V3
21	V1 Peak Max	Maximum peak voltage on phase V1
22	V2 Peak Max	Maximum peak voltage on phase V2
23	V3 Peak Max	Maximum peak voltage on phase V3
		<b>Transient Overvoltages (impulsive voltage)</b>
1	N1 20%	Number of polyphase incidents $u > 20\%$
2	N2 50%	Number of polyphase incidents $u > 50\%$
3	N3 100%	Number of polyphase incidents $u > 100\%$
4	N4 150%	Number of polyphase incidents $u > 150\%$
5	N5 200%	Number of polyphase incidents $u > 200\%$
6	V1 N1 20%	Number of incidents $u > 20\%$ on phase V1
7	V1 N2 50%	Number of incidents $u > 50\%$ on phase V1
8	V1 N3 100%	Number of incidents $u > 100\%$ on phase V1
9	V1 N4 150%	Number of incidents $u > 150\%$ on phase V1
10	V1 N5 200%	Number of incidents $u > 200\%$ on phase V1

Field No.	Designation	Description
11	V2 N1 20%	Number of incidents $u > 20\%$ on phase V2
12	V2 N2 50%	Number of incidents $u > 50\%$ on phase V2
13	V2 N3 100%	Number of incidents $u > 100\%$ on phase V2
14	V2 N4 150%	Number of incidents $u > 150\%$ on phase V2
15	V2 N5 200%	Number of incidents $u > 200\%$ on phase V2
16	V3 N1 20%	Number of incidents $u > 20\%$ on phase V3
17	V3 N2 50%	Number of incidents $u > 50\%$ on phase V3
18	V3 N3 100%	Number of incidents $u > 100\%$ on phase V3
19	V3 N4 150%	Number of incidents $u > 150\%$ on phase V3
20	V3 N5 200%	Number of incidents $u > 200\%$ on phase V3
21	V1 imp max	Maximum impulsive voltage on phase V1
22	V2 imp max	Maximum impulsive voltage on phase V2
23	V3 imp max	Maximum impulsive voltage on phase V3
<b>Supply Voltage Unbalance</b>		
1	Nnv	Number of non-valid 10-min intervals
2	N	Number of valid 10-min intervals
3	N1	Number of incidents $V_{Unb} > 2\%$ , N1
4	N1/N, %	EN50160 compliance ratio, N1/N
5	V Unb% Max	Maximum voltage unbalance
<b>Harmonic Voltage</b>		
1	Nnv	Number of non-valid 10-min intervals
2	N	Number of valid 10-min intervals
3	N1	Number of polyphase harmonic voltage incidents, N1
4	N2	Number of polyphase voltage THD incidents, N2
5	N1/N, %	EN50160 harmonic voltage compliance ratio, N1/N
6	N2/N, %	EN50160 voltage THD compliance ratio, N2/N
7	V1 N1	Number of harmonic voltage incidents on phase V1
8	V1 N2	Number of voltage THD incidents on phase V1
9	V1 HD% Max	Worst-case harmonic magnitude on phase V1, %Un
10	V1 H#	Worst-case harmonic component number on phase V1
11	V1 THD Max	Worst-case voltage THD on phase V1
12	V2 N1	Number of harmonic voltage incidents on phase V2
13	V2 N2	Number of voltage THD incidents on phase V2
14	V2 HD% Max	Worst-case harmonic magnitude on phase V2, %Un
15	V2 H#	Worst-case harmonic component number on phase V2
16	V2 THD Max	Worst-case voltage THD on phase V2
17	V3 N1	Number of harmonic voltage incidents on phase V3
18	V3 N2	Number of voltage THD incidents on phase V3
19	V3 HD% Max	Worst-case harmonic magnitude on phase V3, %Un
20	V3 H#	Worst-case harmonic component number on phase V3
21	V3 THD Max	Worst-case voltage THD on phase V3
<b>Interharmonic Voltage</b>		
1	Nnv	Number of non-valid 10-min intervals
2	N	Number of valid 10-min intervals
3	N1	Number of polyphase interharmonic voltage incidents, N1
4	N2	Number of polyphase interharmonic THD incidents, N2
5	N1/N, %	EN50160 interharmonic voltage compliance ratio, N1/N
6	N2/N, %	EN50160 interharmonic voltage THD compliance ratio, N2/N
7	V1 N1	Number of interharmonic voltage incidents on phase V1
8	V1 N2	Number of interharmonic voltage THD incidents on phase V1
9	V1 HD% Max	Worst-case interharmonic magnitude on phase V1, %Un

Field No.	Designation	Description
10	V1 H#	Worst-case interharmonic component number on phase V1
11	V1 THD Max	Worst-case interharmonic voltage THD on phase V1
12	V2 N1	Number of interharmonic voltage incidents on phase V2
13	V2 N2	Number of interharmonic voltage THD incidents on phase V2
14	V2 HD% Max	Worst-case interharmonic magnitude on phase V2, %Un
15	V2 H#	Worst-case interharmonic component number on phase V2
16	V2 THD Max	Worst-case interharmonic voltage THD on phase V2
17	V3 N1	Number of interharmonic voltage incidents on phase V3
18	V3 N2	Number of interharmonic voltage THD incidents on phase V3
19	V3 HD% Max	Worst-case interharmonic magnitude on phase V3, %Un
20	V3 H#	Worst-case interharmonic component number on phase V3
21	V3 THD Max	Worst-case interharmonic THD on phase V3
<b>Mains Signaling Voltage</b>		
1	Nnv	Number of non-valid 3-sec intervals
2	N	Number of valid 3-sec intervals
3	N1	Number of polyphase incidents, N1
4	N1/N, %	EN50160 compliance ratio, N1/N
5	V1 N1	Number of incidents on phase V1
6	V1 Frq1 %Un	Maximum 1st signaling voltage magnitude on phase V1, %Un
7	V1 Frq2 %Un	Maximum 2nd signaling voltage magnitude on phase V1, %Un
8	V1 Frq3 %Un	Maximum 3rd signaling voltage magnitude on phase V1, %Un
9	V1 Frq4 %Un	Maximum 4th signaling voltage magnitude on phase V1, %Un
10	V2 N1	Number of incidents on phase V2
11	V2 Frq1 %Un	Maximum 1st signaling voltage magnitude on phase V2, %Un
12	V2 Frq2 %Un	Maximum 2nd signaling voltage magnitude on phase V2, %Un
13	V2 Frq3 %Un	Maximum 3rd signaling voltage magnitude on phase V2, %Un
14	V2 Frq4 %Un	Maximum 4th signaling voltage magnitude on phase V2, %Un
15	V3 N1	Number of incidents on phase V3
16	V3 Frq1 %Un	Maximum 1st signaling voltage magnitude on phase V3, %Un
17	V3 Frq2 %Un	Maximum 2nd signaling voltage magnitude on phase V3, %Un
18	V3 Frq3 %Un	Maximum 3rd signaling voltage magnitude on phase V3, %Un
19	V3 Frq4 %Un	Maximum 4th signaling voltage magnitude on phase V3, %Un
20	Frq1	1st signaling voltage frequency
21	Frq2	2nd signaling voltage frequency
22	Frq3	3rd signaling voltage frequency
23	Frq4	4th signaling voltage frequency

**EN50160 Harmonics Survey Log (Data Log #10)**

Field No.	Designation	Description
<b>V1 Harmonic Voltage</b>		
1	THD MAX	Maximum THD
2	THDO MAX	Maximum odd harmonics THD
3	THDE MAX	Maximum even harmonics THD
4	%HD02 MAX	Maximum H02 harmonic voltage magnitude, %Un
5	%HD03 MAX	Maximum H03 harmonic voltage magnitude, %Un
...	...	
52	%HD50 MAX	Maximum H50 harmonic voltage magnitude, %Un
<b>V2 Harmonic Voltage</b>		
1	THD MAX	Maximum THD
2	THDO MAX	Maximum odd harmonics THD
3	THDE MAX	Maximum even harmonics THD

Field No.	Designation	Description
4	%HD02 MAX	Maximum H02 harmonic voltage magnitude, %Un
5	%HD03 MAX	Maximum H03 harmonic voltage magnitude, %Un
...	...	
52	%HD50 MAX	Maximum H50 harmonic voltage magnitude, %Un
		<b>V3 Harmonic Voltage</b>
1	THD MAX	Maximum THD
2	THDO MAX	Maximum odd harmonics THD
3	THDE MAX	Maximum even harmonics THD
4	%HD02 MAX	Maximum H02 harmonic voltage magnitude, %Un
5	%HD03 MAX	Maximum H03 harmonic voltage magnitude, %Un
...	...	
52	%HD50 MAX	Maximum H50 harmonic voltage magnitude, %Un

## Appendix E EN50160 Evaluation and Recording

### EN50160 Background

The EN50160 European standard "Voltage characteristics of electricity supplied by public distribution systems" issued by CENELEC defines the main physical characteristics of electric energy supplied by low and medium voltage public distribution systems under normal operating conditions.

The voltage characteristics are evaluated using a statistical approach. The standard and its referenced publications specify for each voltage characteristic:

- Method of evaluation
- Integrating interval for a single measurement
- Observation period
- Statistical indication of the probability of not exceeding a specified limit
- Standard compliance limits or indicative values within which any customer can expect the voltage characteristics to remain

### Compliance Limits

For some voltage characteristics, the standard provides definite limits that can be complied with for most of the time considering the possibility of relatively rare excursions beyond these limits. Limits are set with a view to compliance for a percentage of the observation time, e.g. 95% of the observations in any period of one week.

The following table gives the characteristics for which definite limits have been specified by the standard.

Voltage characteristic	Compliance with stated limits, % of time	Observation period
Power frequency	±1% for 95% of a week ±1% for 99.5% of a year +4/-6% for 100% of time	Week, year
Voltage variations (supply voltage magnitude)	±10% Un for 95% of time	Week
Rapid voltage changes	≤4-5% Un (up to 10% Un)	Day
Flicker (fluctuations of voltage magnitude)	P <sub>It</sub> ≤ 1 for 95% of time	Week
Voltage unbalance	≤2-3% for 95% of time	Week
Harmonic voltage	THD ≤ 8 for 95% of time	Week
Interharmonic voltage	To be defined	Week
Mains signaling voltage	Within "Meister-curve" for 99% of time	Day

### Indicatives Values

For the remaining characteristics of the voltage, by their unpredictable nature, the standard gives only indicative

values, which are intended to provide users with information on the order of magnitude which can be expected.

The following table gives the characteristics for which indicative values have been specified by the standard.

<b>Voltage Characteristic</b>	<b>Indicative values</b>	<b>Observation period</b>
Voltage dips	Less than 1 s, 60% depth	Year
Short interruptions	70% less than 1 s	Year
Long interruptions	10 to 50% less than 3 min	Year
Temporary overvoltages	Less than 1.5 kV RMS	Year
Transient overvoltages	Less than 6 kV peak	Year

## Resources

CENELEC publications:

EN 50160:1999 Voltage characteristics of electricity supplied by public distribution systems

IEC publications:

IEC 61000-4-7:2002 Electromagnetic compatibility (EMC) – Part 4-7 Testing and measurement techniques – General guide on harmonics and interharmonics measurements and instrumentation, for power supply systems and equipment connected thereto,

IEC 61000-4-15:2003 Electromagnetic compatibility (EMC) – Part 4 Testing and measurement techniques – Section 15: Flickermeter – Functional and design specifications

IEC 61000-4-30:2003 Electromagnetic compatibility (EMC) – Part 4-30 Testing and measurement techniques – Power quality measurement methods

Eurelectric (Union of the Electricity Industry) publications:

Application guide to the European Standard EN 50160 on Voltage characteristics of electricity supplied by public distribution systems, Ref: 23002 Ren9530, July 1995

Measurement guide for voltage characteristics, Ref: 23002 Ren9531, July 1995

## Evaluation Techniques

### Evaluation Counters and Evaluation Period

The EM720 uses a set of the evaluation counters for collecting EN50160 statistics within a specified evaluation period.

The evaluation period is the period of time within which the meter collects statistical evaluation data. Supply voltage characteristics can be evaluated on a weekly or daily basis. The evaluation period being normally preset in your meter to a week can be changed via the EN50160 Advanced setup.

At the end of the evaluation period, the meter records collected statistical evaluation data to a log file, and then

clears the evaluation registers and counters so that each evaluation period's statistics is stored in a separate record.

You can upload and view the online statistics data via PAS reports, using data collected since the beginning of the present evaluation interval. You can also manually clear the present contents of the counters through PAS before starting your EN50160 evaluation.

### Observation Period

The observation period is the period of time within which the voltage characteristics shall be assessed to ensure compliance with the standard. The observation periods declared by the EN50160 may differ for characteristics for which compliance limits are specified in the standard, usually one week, and for those for which only indicative values are provided, usually one year.

The EN50160 compliance reports produced by PAS provide correct weekly and yearly observation statistics regardless of the evaluation periods used for collecting data. Whenever needed, PAS will aggregate records within a number of the evaluation intervals to provide correct observation periods. Some of the characteristics, like rapid voltage changes or mains signaling voltage, may require daily assessments. If you intend to use daily-evaluated voltage characteristics, select the daily evaluation period via the EN50160 Advanced setup.

## Methods of Evaluation

This section describes methods used by the EM720 for evaluating supply voltage characteristics to ensure compliance with the standard.

### Frequency Variations

#### Method of Evaluation

The basic frequency measurement is the mean value of the frequency over fixed time intervals of 10 seconds under normal operating conditions.

A frequency variation is not evaluated if the supply voltage crosses a voltage tolerance limit ( $\pm 15\% U_n$ ).

#### Target Values

The ranges of frequency variations given in the EN50160 are:

- 50Hz $\pm 1\%$  for 95% of a week
- 50Hz $\pm 1\%$  for 99.5% of a year
- 50Hz+4/-6% for 100% of the time

The same limits are used for 60Hz systems. The frequency compliance limit can be programmed in the meter in percent of the nominal power frequency via the EN50160 PQ Recorder setup.

## Supply Voltage Variations

This characteristic defines slow variations of steady state supply voltage magnitude.

### Method of Evaluation

The basic supply voltage magnitude measurement is the RMS value of the steady state voltage over a period of 10 minutes under normal operating conditions.

A voltage variation is not evaluated if the supply voltage crosses a voltage tolerance limit ( $\pm 15\% U_n$ ).

### Target Values

The range of voltage variations given in the EN50160 is:

$$\pm 10\% U_n \text{ for 95\% of a week}$$

The supply voltage compliance limit can be changed in the meter via the EN50160 PQ Recorder setup.

## Rapid Voltage Changes

Rapid voltage changes are sudden but relatively weak voltage variations between two steady state voltage levels.

### Method of Evaluation

Evaluation of rapid voltage changes is made on an hourly basis. The RMS voltage is evaluated over 1-second time integration intervals. The meter establishes the maximum difference of the RMS voltage between two intervals selected from three 1-second consecutive intervals and compares it with the target compliance limit.

A rapid voltage change is not classified if it crosses a voltage tolerance limit ( $\pm 10\% U_n$ ), as it would be considered a voltage dip or a temporary overvoltage.

### Target Values

The maximum rate of rapid voltage changes is normally once per hour or less. For voltage variations repeating more than once an hour, amplitude is limited by the flicker index. The maximum rate of rapid voltage changes in variations per hour can be changed in the meter via the EN50160 Advanced Setup. The target magnitude limit of rapid voltage changes can be programmed in the meter via the EN50160 PQ Recorder setup.

Under usual operating conditions the magnitude of rapid voltage changes (once per hour or less) should generally not exceed 5% of nominal voltage in LV networks, and 4% in MV networks. In some circumstances, like in systems where equipment switching must be carried out to meet supply system or load requirements, it can reach  $10\%U_n$  in LV networks, and  $6\%U_n$  in MV networks.

## Flicker

Flicker expresses the visual discomfort caused by repetitive changes of brightness in lightning subjected to fluctuations of



the supply voltage. Flicker is indicated by the long-term flicker severity parameter Plt, which is evaluated every 2 hours.

#### Method of Evaluation

The basic measurement is the short-term flicker severity indicator Pst, evaluated each 10 minutes by instrumentation complying with IEC 61000-4-15. The indicative long-term flicker severity Plt is evaluated from 12 consecutive Pst values. For testing purposes, the Pst period can be temporarily changed in the meter in the range of 1 to 10 minutes via the EN50160 Advanced Setup.

Pst values are not classified during intervals when the supply voltage magnitude exceeds a voltage tolerance limit ( $\pm 15\%$  Un) or is affected by voltage dips with depth more than 15% Un.

#### Target Values

The flicker compliance limit given in the EN50160 is:

$$Plt \leq 1 \text{ for 95\% of a week}$$

The Plt compliance limit can be changed in the meter via the EN50160 PQ Recorder setup.

### Voltage Dips

A voltage dip is a sudden reduction of the RMS voltage below 90% of the nominal value, followed by a return to a value higher than 90% of the nominal in a time varying from 10 ms to 60 s.

#### Method of Evaluation

A voltage dip is classified as one polyphase event regardless of the shape and of the number of phases affected (as per Eurelectric's Application guide to the European Standard EN 50160, and IEC 61000-4-30). An event can begin on one phase and end on another phase. The fault magnitude is recorded separately for each phase involved. The event duration is measured from the instant at which the voltage falls below the start threshold on one of the phases to that at which it becomes greater than the end threshold on all affected phases including a threshold hysteresis.

The basic voltage dip measurement is one-cycle RMS voltage updated each half-cycle.

The voltage dip threshold can be changed in the meter via the EN50160 PQ Recorder setup.

#### Statistical Results

The EM720 provides the statistical evaluation of voltage dips using the classification established by UNIPED. Dips are classified by residual voltage magnitude and duration as shown in Appendix D.

### Indicative Values

Under normal operating conditions the expected number of voltage dips in a year may be from up to a few tens to up to one thousand. The majority of voltage dips have a duration less than 1 s and a depth less than 60%.

## Voltage Interruptions

Voltage interruptions correspond to temporary loss of supply voltage on all phases lasting less than or equal to 3 minutes in the event of short interruptions, and more than 3 minutes for long interruptions.

### Method of Evaluation

The voltage interruption is detected when the voltages on all phases fall below the interruption threshold (as per IEC 61000-4-30) specified by the EN50160 at a level of 1%Un. The interruption threshold can be changed in the meter via the EN50160 PQ Recorder setup.

The basic voltage measurement is one-cycle RMS voltage updated each half-cycle.

### Statistical Survey

The EM720 provides the statistical evaluation of voltage interruptions using the classification recommended by Eurelectric's Measurement guide for voltage characteristics.

Interruptions are classified by duration as shown in Appendix D.

### Indicative Values

Under normal operating conditions the expected number of short voltage interruptions in a year may be from up to a few tens to up to several hundreds. Short interruptions generally last less than a few seconds.

The annual frequency of long interruptions may be less than 10 or up to 50 depending on the area.

## Temporary Overvoltages

Temporary overvoltages are sudden rises of the voltage RMS value of more than 110% of nominal voltage. Temporary overvoltages may last between 10 milliseconds and one minute.

### Method of Evaluation

A temporary overvoltage is classified as one polyphase event regardless of the shape and of the number of phases affected (as per IEC 61000-4-30). An event can begin on one phase and end on another phase. The fault magnitude is recorded separately for each phase involved. The event duration is measured from the instant at which the voltage rises above the start threshold on one of the phases to that at which it becomes lower than the end threshold on all affected phases including a threshold hysteresis.

The overvoltage threshold can be changed in the meter via the EN50160 PQ Recorder setup.

The basic voltage measurement is one-cycle RMS voltage updated each half-cycle.

#### Statistical Survey

The EM720 provides the statistical evaluation of temporary overvoltages using the classification recommended by Eurelectric's Measurement guide for voltage characteristics. Temporary overvoltages are classified by voltage magnitude and duration as shown in Appendix D.

#### Indicative Values

Temporary overvoltages on the low voltage side will generally not exceed 1.5 kV RMS.

### Transient Overvoltages

Transient overvoltages correspond to disturbances of very short duration, lasting typically less than one half-cycle, i.e. a few microseconds to several milliseconds.

#### Method of Evaluation

Transient overvoltages are detected as impulsive or low frequency oscillatory transients with a rise time less than 0.5 ms and duration from 20  $\mu$ s with the Fast Transient coprocessor option or from 75  $\mu$ s without it and to  $\frac{1}{2}$  cycle. The impulse magnitude is evaluated either by the peak voltage value, or by the impulse amplitude, and is referenced to the nominal voltage amplitude ( $1.414 U_n$ ). The meter can detect transient overvoltages with a magnitude of up to 2 kV with the fast transient coprocessor option or up to 700V without it.

#### Statistical Survey

The EM720 provides the statistical evaluation of transient overvoltages using the classification recommended by Eurelectric's Measurement guide for voltage characteristics. Transient overvoltages are classified by voltage magnitude as shown in Appendix D.

#### Indicative Values

Transient overvoltages in LV systems will generally not exceed 6 kV peak, but higher values occur occasionally.

### Voltage Unbalance

This characteristic defines the magnitude and/or phase asymmetries of three-phase steady state supply voltage.

#### Method of Evaluation

The basic measurement is the RMS value of the steady state voltage unbalance over a period of 10 minutes under normal operating conditions. It is defined using the theory of symmetrical components by the negative sequence

component expressed in percent of the positive sequence component.

Voltage unbalance is not evaluated if the supply voltage crosses a voltage tolerance limit ( $\pm 15\% U_n$ ).

### Target Values

The range of voltage unbalance given in the EN50160 is:

$\leq 2\%$  ( $\leq 3\%$  in some areas) for 95% of a week

The voltage unbalance compliance limit can be changed in the meter via the EN50160 PQ Recorder setup.

## Harmonic Voltage

### Method of Evaluation

The basic measurements are the individual harmonic voltage distortion factors (HD) and the total harmonic distortion factor (THD) over a period of 10 minutes under normal operating conditions.

Harmonic voltages are evaluated by instrumentation complying with IEC 61000-4-7. All calculations are made relative to the nominal voltage.

The THD is evaluated including all harmonics up to the order 40. Harmonic voltages are evaluated up the order 25 since the EN50160 provides target values for individual harmonic voltages only for orders up to 25. The highest harmonic order for evaluating individual harmonic voltages and THD can be changed in the meter in the range of 25 to 50 via the EN50160 Advanced Setup.

Harmonic voltages are not evaluated if the supply voltage crosses a voltage tolerance limit ( $\pm 15\% U_n$ ).

### Target Values

The ranges of harmonic voltages given in the EN50160 are:

- THD  $\leq 8\%$  for 95% of a week
- Individual harmonic voltages shall be less than or equal to the values given in Table 1 Clause 2.11 of the EN50160 for 95% of a week.

The THD compliance limit can be changed in the meter via the EN50160 PQ Recorder setup. The individual harmonic voltage limits can be adjusted via the EN50160 Harmonics setup.

## Interharmonic Voltage

### Method of Evaluation

Since the EN50160 does not specify target limits for interharmonic voltages, this feature is normally disabled in your meter. You can enable evaluation of interharmonic voltages via the EN50160 Advanced Setup.

The basic measurements are the individual interharmonic voltage distortion factors (HD) and the total interharmonic

distortion factor (THD) over a period of 10 minutes under normal operating conditions.

Interharmonic voltages are evaluated by instrumentation complying with IEC 61000-4-7. All calculations are made relative to the nominal voltage.

The highest harmonic order for evaluating individual interharmonic voltages and interharmonic THD can be selected in the meter in the range of 25 to 50 via the EN50160 Advanced setup.

Interharmonic voltages are not evaluated if the supply voltage crosses a voltage tolerance limit ( $\pm 15\% U_n$ ).

### Target Values

The EN50160 does not provide target limits for interharmonic voltages. The ranges of interharmonic voltages selected in the EM720 are:

- Interharmonic THD  $\leq 2\%$  for 95% of a week
- Individual interharmonic voltages shall be less than or equal to the values given in the following table for 95% of a week.

Interharmonic order	Relative Voltage
2	0.2
3-15	1.0
16-25	0.5

You can change the compliance limit for the interharmonic THD via the EN50160 PQ Recorder setup. The individual interharmonic voltage limits can be changed via the EN50160 Harmonics setup.

## Mains Signaling Voltage

This characteristic defines the magnitude of the signal voltages used in some countries for signal transmission over public supply networks. These may include ripple control signals in a frequency range from 100 Hz to 3 kHz, and carrier wave communications signals in a frequency range from 3 kHz to 148.5 kHz.

The EM720 can evaluate ripple control signaling voltages in a frequency range from 100 Hz to 3 kHz.

### Method of Evaluation

Since evaluating signal voltages is not commonly used, this feature is normally disabled in your meter. You can enable evaluation of signaling voltages via the EN50160 Advanced Setup.

The EM720 evaluates up to four ripple control frequencies. You can select the required signaling frequencies via the EN50160 Advanced Setup.

The basic measurement is the magnitude of the signaling voltage over a period of 3 seconds under normal operating conditions.

Signaling voltages are not evaluated if the supply voltage crosses a voltage tolerance limit ( $\pm 15\% U_n$ ).

#### Target Values

The voltage levels given by the EN50160 in Figure 1 of Clause 2.13 are taken from the so-called "Meister-curve" which defines the maximum permissible ripple control voltages in LV networks.

Compliance with the EN50160 requires that the 3-second mean of signal voltages shall be less or equal to the specified limits for 99% of a day.

## Appendix F Data Scales

The maximum values for volts, amps and powers in the EM720 setup and in communications are limited by the voltage and current scale settings. See [Device Options and Mode Control](#) in Chapter 5 on how to change the voltage and current scales in your meter.

The following table shows the meter data scales.

Scale	Range
Maximum voltage (V max)	Voltage scale $\times$ PT Ratio, V <sup>1</sup>
Maximum current (I max)	Current scale $\times$ CT Ratio, A <sup>2, 3</sup>
Maximum Power (P max) <sup>4</sup>	V max $\times$ I max $\times$ 2, W
Maximum frequency	100 Hz

<sup>1</sup> The default voltage scale is 144V (120V+20%).

<sup>2</sup> CT Ratio = CT primary current/CT secondary current

<sup>3</sup> The default current scale is 2  $\times$  CT secondary (2.0A with 1A secondaries and 10.0A with 5A secondaries).

<sup>4</sup> Maximum power is rounded to whole kilowatts. With PT=1.0, it is limited to 9,999,000 W.

## Appendix G Device Diagnostic Codes

Diagnostic Code	Display Message	Description	Reason
2	RAM/Data fault	RAM/Data error	Hardware failure
3	Watchdog reset	Hardware watchdog reset	Hardware failure
4	Sampling fault	DSP/Sampling fault	Hardware failure
5	CPU exception	CPU exception	Hardware failure
6	Run-time error	Run-time error	Hardware failure
7	SW watchdog reset	Software watchdog timeout	Hardware failure
8	Power down	Power down	Loss of power
9	Device reset	Warm restart/Device reset	External restart via communications or by firmware upgrade.
10	Configuration reset	Configuration reset	Corrupted setup data has been replaced with the default configuration.
11	RTC fault	RTC fault	The clock time has been lost. With auto-reset: cleared automatically as the clock is updated.
12	Configuration fault	Configuration fault	Factory, calibration or basic device configuration data has been corrupted.
13	Low battery	Battery low	Low lithium battery. With auto-reset. Battery check or replacement is required.
14	Exp. memory fault	Expanded memory fault	Hardware failure
15	CPU EEPROM fault	CPU EEPROM fault	Hardware failure
18	Coprocessor fault	Coprocessor fault	Hardware failure
20	Library error	C Library error	Hardware failure
22	Task error	Task error	Hardware failure
24	IRIG-B No signal	IRIG-B signal lost	No IRIG-B signal from the GPS master clock. With auto-reset: cleared automatically when the IRIG-B signal is detected.
25	IRIG-B Unlocked	IRIG-B time unlocked	The GPS master clock has lost the satellite signal. With auto-reset: cleared automatically when the satellite signal is locked.
27	Magnet. interference	Magnetic interference	Indicates presence of a high electromagnetic field that can affect accuracy of energy measurements. With auto-reset.
29	Motion/tilt sensor	Motion/tilt sensor	The meter has been moved or tilted.

See [Device Diagnostics](#) for more information on the EM720 built-in diagnostics. See [Device Diagnostics Display](#) in Chapter 3 and [Clearing Device Diagnostics](#) in Chapter 6 on how to inspect and clear the device diagnostics in your meter.



## Appendix H OBIS Identification Codes

The OBIS (Object Identification System IEC 62056-61) codes are used to identify energy and maximum demand readings in the IEC 62056-21 protocol (see the EM720 IEC 62056-21 Reference Guide) and in the billing data displays on the EM720 front display.

The OBIS code structure used in the EM720 is as follows:

**B : C.D.E \* F**

where

B – energy metering channel 1-6. Not indicated for a single self-metering channel when no external channels are defined.

C – identifies a physical instrumentation quantity, like the type of a source power and its direction. 0 identifies general purpose objects.

D – identifies a quantity processing algorithm, like time accumulation, maximum and cumulative maximum.

E – tariff rate 1...8, or 0 for total readings.

F – billing period 0-99, 0 (or not shown) for present billing period, 1 for the first previous (last) period, 2 for the second previous billing period, and so on.

The following table lists the OBIS codes used in the EM720 billing data displays.

OBIS Code	Unit	Description
0.1.0		Billing period counter
0.1.2 * F		Timestamp of the billing period
0.8.6 * F	Day	Billing period duration
1.8.0	kWh	kWh import (Q1+Q4), total
1.8.1-1.8.8	kWh	kWh import (Q1+Q4), tariff 1-8
2.8.0	kWh	kWh export (Q2+Q3), total
2.8.1-2.8.8	kWh	kWh export (Q2+Q3), tariff 1-8
3.8.0	kvarh	kvarh import (Q1+Q2), total
3.8.1-3.8.8	kvarh	kvarh import (Q1+Q2), tariff 1-8
4.8.0	kvarh	kvarh export (Q3+Q4), total
4.8.1-4.8.8	kvarh	kvarh export (Q3+Q4), tariff 1-8
5.8.0	kvarh	kvarh Q1, total
5.8.1-5.8.8	kvarh	kvarh Q1, tariff 1-8
6.8.0	kvarh	kvarh Q2, total
6.8.1-6.8.8	kvarh	kvarh Q2, tariff 1-8
7.8.0	kvarh	kvarh Q3, total
7.8.1-7.8.8	kvarh	kvarh Q3, tariff 1-8
8.8.0	kvarh	kvarh Q4, total
8.8.1-8.8.8	kvarh	kvarh Q4, tariff 1-8
9.8.0	kVAh	kVAh (Q1+Q2+Q3+Q4), total
9.8.1-9.8.8	kVAh	kVAh (Q1+Q2+Q3+Q4), tariff 1-8
9.8.0	kVAh	kVAh import (Q1+Q4), total
9.8.1-9.8.8	kVAh	kVAh import (Q1+Q4), tariff 1-8
10.8.0	kVAh	kVAh export (Q2+Q3), total
10.8.1-10.8.8	kVAh	kVAh export (Q2+Q3), tariff 1-8

Appendix H OBIS Identification Codes

OBIS Code	Unit	Description
1.6.0	kW/MW	kW import maximum demand, total
1.6.1-1.6.8	kW/MW	kW import maximum demand, tariff 1-8
2.6.0	kW/MW	kW export maximum demand, total
2.6.1-2.6.8	kW/MW	kW export maximum demand, tariff 1-8
3.6.0	kvar/Mvar	kvar import maximum demand, total
3.6.1-3.6.8	kvar/Mvar	kvar import maximum demand, tariff 1-8
4.6.0	kvar/Mvar	kvar export maximum demand, total
4.6.1-4.6.8	kvar/Mvar	kvar export maximum demand, tariff 1-8
5.6.0	kvar/Mvar	kvarh Q1 maximum demand, total
5.6.1-5.6.8	kvar/Mvar	kvarh Q1 maximum demand, tariff 1-8
6.6.0	kvar/Mvar	kvarh Q2 maximum demand, total
6.6.1-6.6.8	kvar/Mvar	kvarh Q2 maximum demand, tariff 1-8
7.6.0	kvar/Mvar	kvarh Q3 maximum demand, total
7.6.1-7.6.8	kvar/Mvar	kvarh Q3 maximum demand, tariff 1-8
8.6.0	kvar/Mvar	kvarh Q4 maximum demand, total
8.6.1-8.6.8	kvar/Mvar	kvarh Q4 maximum demand, tariff 1-8
9.6.0	kVA/MVA	kVA maximum demand, total
9.6.1-9.6.8	kVA/MVA	kVA maximum demand, tariff 1-8
9.6.0	kVA/MVA	kVAh import maximum demand, total
9.6.1-9.6.8	kVA/MVA	kVAh import maximum demand, tariff 1-8
10.6.0	kVA/MVA	kVAh export maximum demand, total
10.6.1-10.6.8	kVA/MVA	kVAh export maximum demand, tariff 1-8
1.2.0	kW/MW	kW import cumulative maximum demand, total
1.2.1-1.2.8	kW/MW	kW import cumulative maximum demand, tariff 1-8
2.2.0	kW/MW	kW export cumulative maximum demand, total
2.2.1-2.2.8	kW/MW	kW export cumulative maximum demand, tariff 1-8
3.2.0	kvar/Mvar	kvar import cumulative maximum demand, total
3.2.1-3.2.8	kvar/Mvar	kvar import cumulative maximum demand, tariff 1-8
4.2.0	kvar/Mvar	kvar export cumulative maximum demand, total
4.2.1-4.2.8	kvar/Mvar	kvar export cumulative maximum demand, tariff 1-8
5.2.0	kvar/Mvar	kvarh Q1 cumulative maximum demand, total
5.2.1-5.2.8	kvar/Mvar	kvarh Q1 cumulative maximum demand, tariff 1-8
6.2.0	kvar/Mvar	kvarh Q2 cumulative maximum demand, total
6.2.1-6.2.8	kvar/Mvar	kvarh Q2 cumulative maximum demand, tariff 1-8
7.2.0	kvar/Mvar	kvarh Q3 cumulative maximum demand, total
7.2.1-7.2.8	kvar/Mvar	kvarh Q3 cumulative maximum demand, tariff 1-8
8.2.0	kvar/Mvar	kvarh Q4 cumulative maximum demand, total
8.2.1-8.2.8	kvar/Mvar	kvarh Q4 cumulative maximum demand, tariff 1-8
9.2.0	kVA/MVA	kVA cumulative maximum demand, total
9.2.1-9.2.8	kVA/MVA	kVA cumulative maximum demand, tariff 1-8
9.2.0	kVA/MVA	kVAh import cumulative maximum demand, total
9.2.1-9.2.8	kVA/MVA	kVAh import cumulative maximum demand, tariff 1-8
10.2.0	kVA/MVA	kVAh export cumulative maximum demand, total
10.2.1-10.2.8	kVA/MVA	kVAh export cumulative maximum demand, tariff 1-8