

HACS - High Accuracy Current Sensors DATASHEET

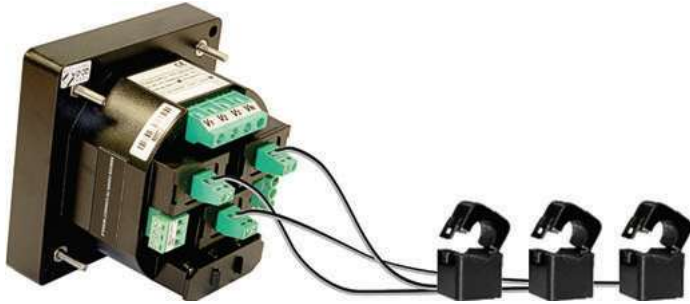

- + Superior Accuracy
- + Anti-hazard safety switch: no shorting-blocks needed
- + Remote installation: up to 200M from load to meter

THE SUPERIOR SATEC CURRENT TRANSFORMER BRAND, DESIGNED FOR SATEC METERS' HACS MODELS

SATEC's HACS concept CTs are designed to bring accuracy in energy metering, and the safety of your facility to a new level.

With nearly 100,000 units currently installed (2020) in different commercial, industrial, residential and utility applications, SATEC's HACS CTs are your safest bet for a safe facility, easy installation and high accuracy, which is what metering is all about.

Most SATEC meters are available with the following current input options:

1. 1A standard current input
2. 5A standard current input
3. HACS fitted milliamp current input

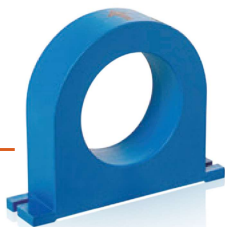

Solid-core for maximum accuracy (0.1%)



Electrical-switch for fire-hazard prevention



Split-core for retro-fit

Milliamp output for low burden and remote metering

“ONE-CT SYSTEM” FOR DIRECT METERING, FEEDING A 40MA INPUT DIRECTLY TO METER

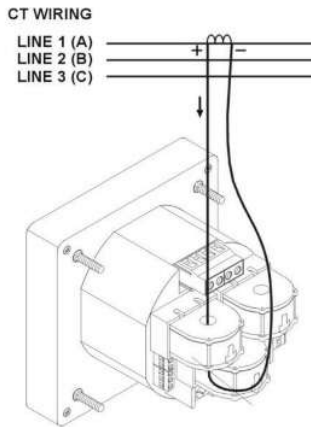

SATEC PM130 PLUS with Standard 1A or 5A inputs

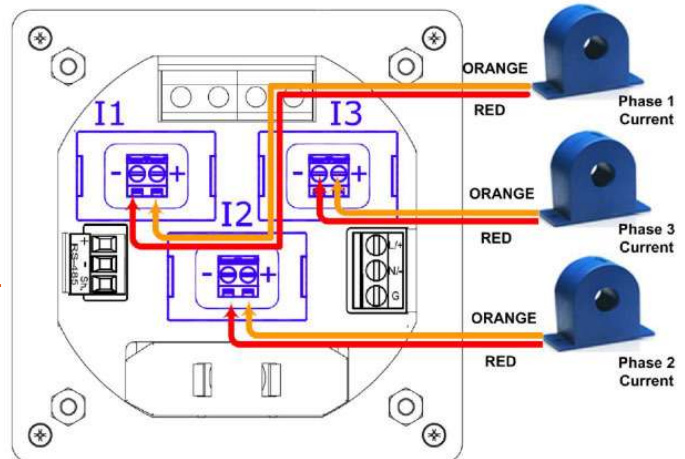

SATEC PM130 PLUS
 HACS model 40mA inputs



HACS COMPATIBLE MODELS

SATEC products with HACS-model availability:

- ▶ EM13x-HACS/RS5
- ▶ PM13x-HACS/RS5
- ▶ BFM136 (only HACS compatible)
- ▶ BFM II (only HACS compatible)
- ▶ PM17x-HACS/RS5
- ▶ PM180 (several models, consult manual)
- ▶ PRO PM335-HACS/RS5
- ▶ PRO EM235-HACS/RS5

HIGHLIGHTS & FEATURES

MAXIMUM ACCURACY

What are we fixing?

Standard energy meters feature current inputs typically rated at 5A or 1A, making the meter reliant on an external CT to step-down standard distributed electrical currents. These two step-down transformations (external + internal) result in a combined error which is the product of an aggregation of factors:

1. Meter error: affected by amplifiers, A/D converters, passive components and noise resulting from circuit design
2. Meter's built-in CT error
3. External CT error
4. CT phase shift: an additional parameter affecting accuracy, varying, even within the same product of any manufacturer, from one batch to the another.

SATEC ACCURACY

SATEC designs its meters in compliance with a minimal accuracy standard of Class 0.5S. Many SATEC products feature a yet more advanced accuracy standard of Class 0.2S. To guarantee overall system accuracy, featuring a minimal metering error, SATEC designed the HACS CTs.

The HACS feed their secondary current (outputs) directly into corresponding designated SATEC meter models which feature low current inputs (mA). The HACS and the meters are designed for each other.

MAXIMUM SAFETY

What are we fixing?

An unfortunately familiar phenomenon is that of current transformers which catch fire or explode when disconnected. This happens as a result of the CTs being disconnected without short-circuiting them first, either mistakenly by maintenance workers/engineers or even simply over time, without any human intervention. The alternative scenario is that of intentional disconnect for maintenance without using the necessary shorting blocks.

THE HACS SAFETY FEATURE

- ▶ SATEC HACS feature an electronic switch which provides an automatic protection circuit for maximum safety. This prevents the fires and explosions, discussed above, which unfortunately occasionally occur when standard CTs are improperly disconnected.

MAXIMUM CONVENIENCE

- ▶ Benefit from the protection circuit with any disconnection initiated – no shorting blocks needed!
- ▶ The extremely low burden which characterizes the HACS allows the user to run wiring from the meter to loads positioned up to 200 meters away from the SATEC power-meter, without any compromise whatsoever on accuracy, employing wiring as thin as 16 AWG.

TECHNICAL SPECIFICATIONS

ORDER STRING
(CATALOG NO.)

CS05S / RS5
(HX0140)

CS1
(EL0072)

CS1L
(EL0115)

CS1S
(HX0118)



RATED CURRENT

5A

100A

100A

100A

WINDOW

Ø 16mm
Ø 0.62"

Ø 12mm
Ø 0.47"

Ø 23mm
Ø 0.9"

Ø 16mm
Ø 0.63"

CORE

Split

Solid

Solid

Split

ACCURACY [%]

0.5

0.1

0.1

0.5

WEIGHT

98.2g
0.22 lbs

156.4g
0.34 lbs

206.3g
0.45 lbs

103.4g
0.23 lbs

ORDER STRING
(CATALOG NO.)

CS1H
(HX0161)

CS2
(EL0142)

CS2S
(HX0145)

CS2SL
(HX0156)

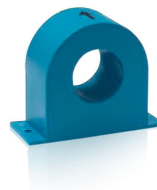

RATED CURRENT

100A

200A

200A

200A

WINDOW

Ø 13mm
Ø 0.5"

Ø 23mm
Ø 0.9"

25×23mm
0.96×0.9"

43×33mm
1.69×1.3"

CORE

Split

Solid

Split

Split

ACCURACY [%]

0.1/0.2

0.1

0.5

0.5

WEIGHT

280g
0.6 lbs

206.3g
0.45 lbs

160g
0.34 lbs

450g
1 lbs

TECHNICAL SPECIFICATIONS
ORDER STRING
(CATALOG NO.)

CS250S
(HX0166)

CS4
(EL0117)

CS4S
(HX0157)

RATED CURRENT	250A	400A	400A
WINDOW	24x25mm 0.94x0.98"	Ø 26mm Ø 1.02"	43x33mm 1.69x1.3"
CORE	Split	Solid	Split
ACCURACY [%]	0.5	0.1	0.5
WEIGHT	210g 0.46 lbs	214g 0.47 lbs	450g 1 lbs

ORDER STRING
(CATALOG NO.)

CS4L
(EL0153)

CS8
(EL0180)

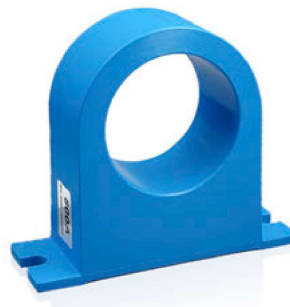
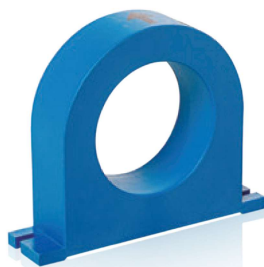
CS8S
(HX0158)

RATED CURRENT	400A	800A	800A
WINDOW	Ø 45mm Ø 1.77"	Ø 60mm Ø 2.36"	80x50mm 3.1x1.9"
CORE	Solid	Solid	Split
ACCURACY [%]	0.1	0.1S	0.5
WEIGHT	300g 0.66 lbs	577g 1.27 lbs	900g 1.9 lbs

TECHNICAL SPECIFICATIONS
ORDER STRING
(CATALOG NO.)

CS12S
(HX0153)

CS20S
(HX0154)

CS30S
(HX0155)

RATED CURRENT	1200A	2000A	3000A
WINDOW	120x80mm 4.7x3.1"	160x80mm 6.3x3.15"	160x80mm 6.3x3.15"
CORE	Split	Split	Split
ACCURACY [%]	0.5	0.5	0.5
WEIGHT	1.25kg 2.75 lbs	4.3kg 9.4 lbs	4.3kg 9.4 lbs

TECHNICAL SPECIFICATIONS

Rated frequency	40-70 Hz
Cord voltage rating	600V AC
Core insulation	4,000V AC
Lead length	2.5m / 8.2ft (UL1015)
Operating temperature	-40°C to +70°C
Storage temperature	-40°C to +85°C
Material	All materials are UL approved
Standard	IEC 61869-1, IEC 61869-2
Burden	0.2 VA
Short time over current	30xI _{rated} @ 10ms

STANDARD COMPLIANCE
IEC 61869-1

Instrument transformers part 1:
General requirements

IEC 61869-2

Instrument transformers part 2:
Additional requirements for current transformers

INSTALLATION RECOMMENDATIONS

All HACS include a built-in automatic protection circuit for maximum safety, eliminating the need to use shorting bars.

- ▶ All HACS are supplied with 8ft / 2.5m cable.
- ▶ Maximum cable length: 650ft / 200m.
- ▶ Recommended wire gauge: ≥ 1.5 mm²

It is recommended to use a shielded twisted extension cable to connect between the HACS and the SATEC meter. The cable shield must be connected to protective ground.

It is recommended to locate HACS cable in separate cable conduit and at least 1m (3ft) away from High Voltage circuits, and / or other high power magnetic fields.

HACS CONFIGURATION IN METERING UNIT

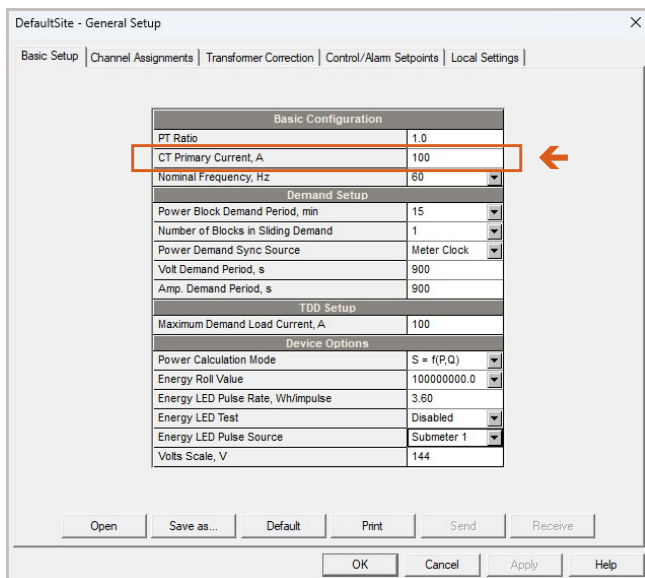

When configuring the meter, make sure to set the value of the HACS CT's primary current, either via the front panel of the unit or via the PAS software.

Set the "Primary current" value in the unit configuration as HALF the value stated above in sheet as "RATED CURRENT", per each HACS CT model. e.g., for the CS4S model, rated at 400A, feed "200" as primary current.

RS5 Primary Current: the RS5 model stands as an exception, in which the value entered is "5".

Configuring the PM180 analyzer: rated values vary when configuring the product. Please consult the PM180 manual.

CT DIMENSIONS

CS05S / RS5
(HX0140)

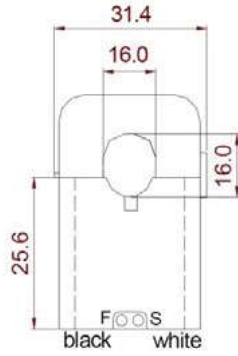

Front view

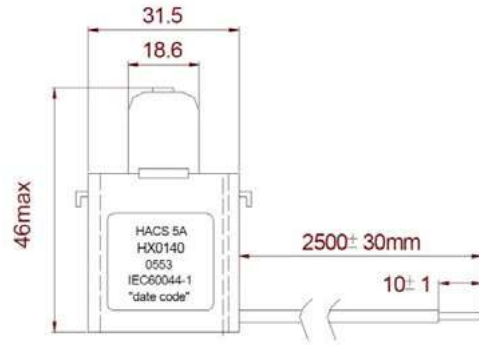

Left view

CS1
(EL0072)

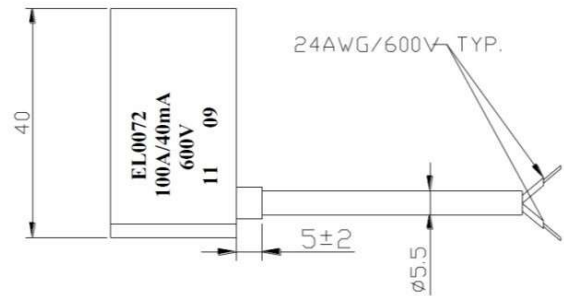
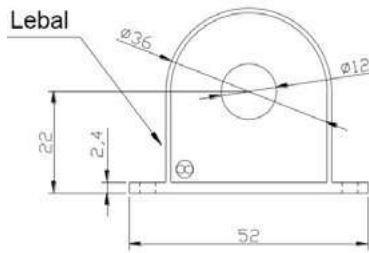

CS1L
(EL0115)

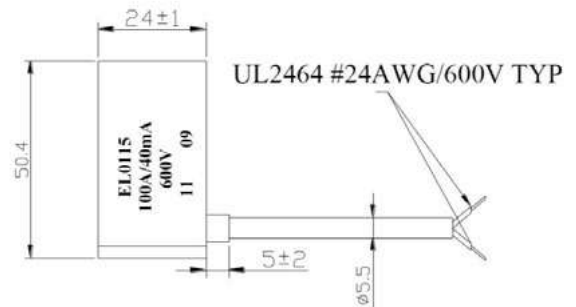
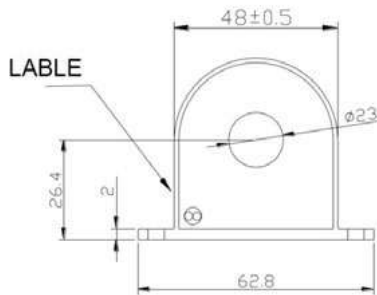

CS1S
(HX0118)

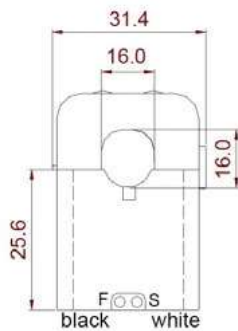

Front view

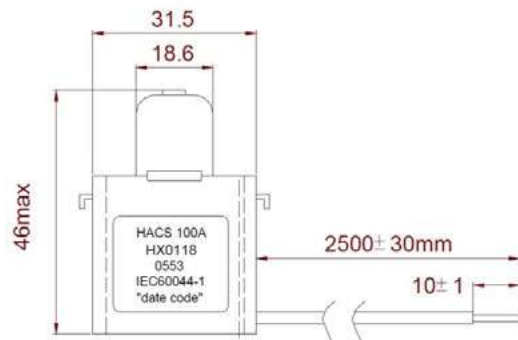

Left view

CT DIMENSIONS

**CS1H
(HX0161)**

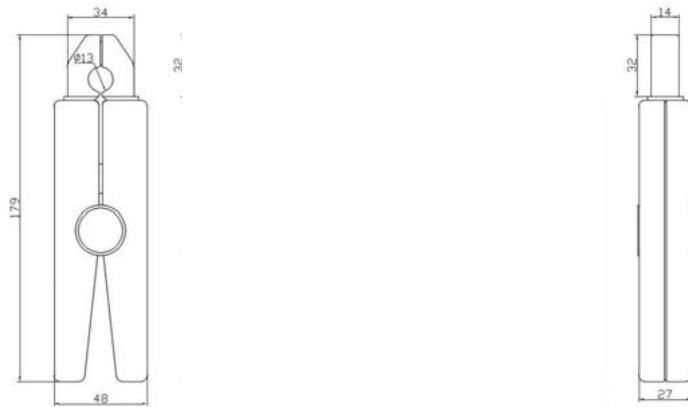

**CS2
(EL0142)**

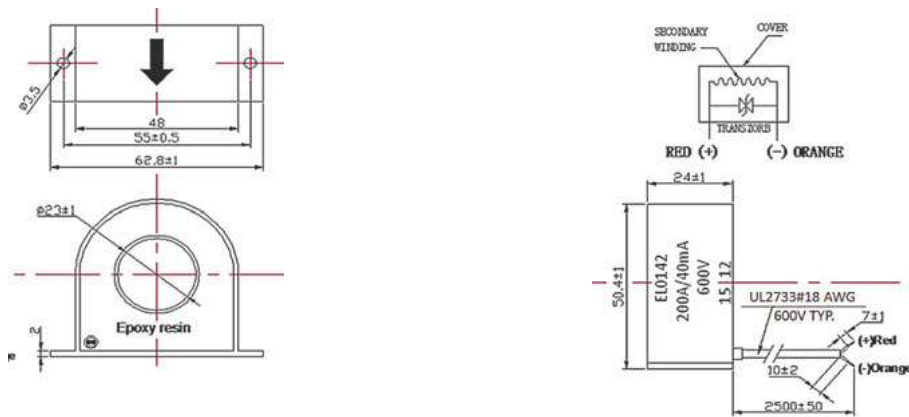

**CS2S
(HX0145)**

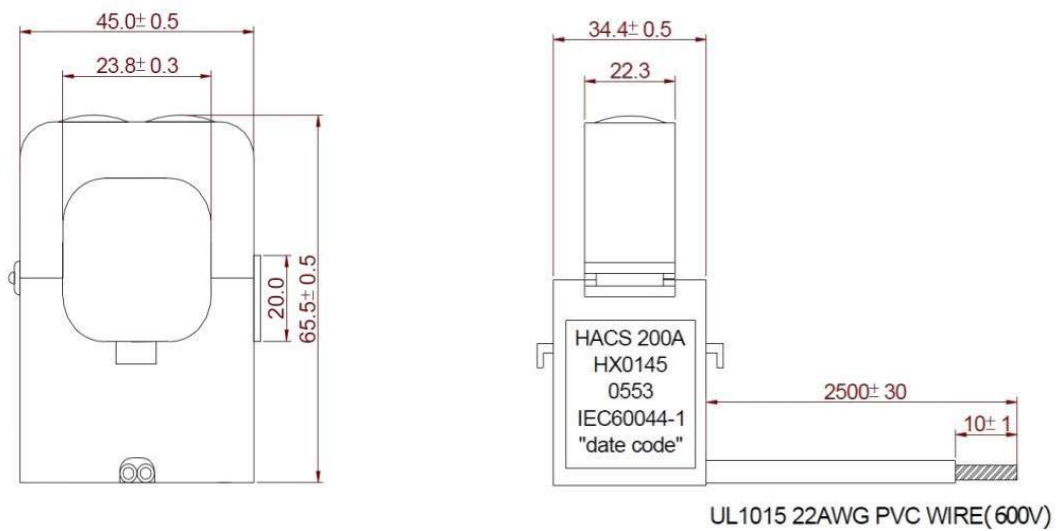

**CS2SL
(HX0156)**

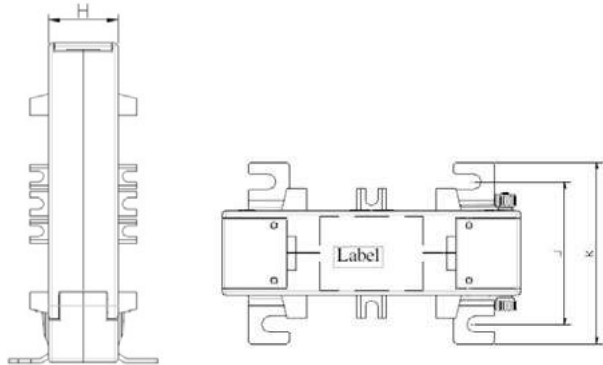
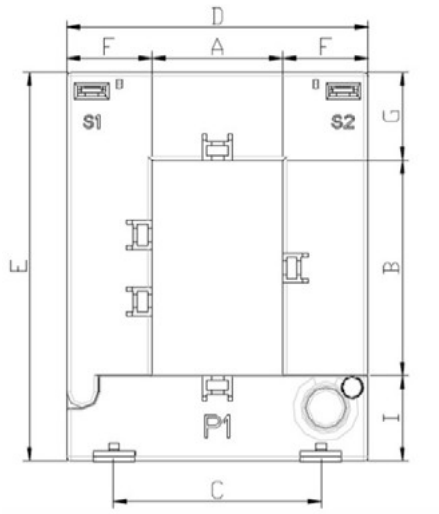

A	B	C	D	E	F	G	H	I	J	K
33	43	45	92	100	29.5	30	28	27	50	65

**CS255
(HX0166)**

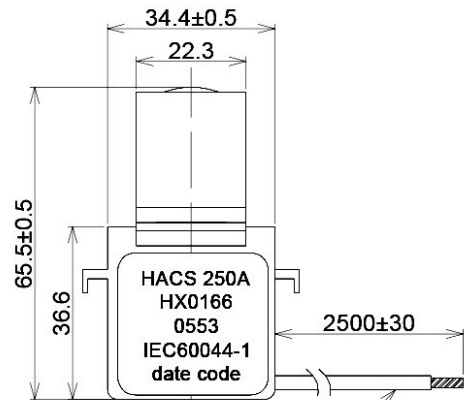
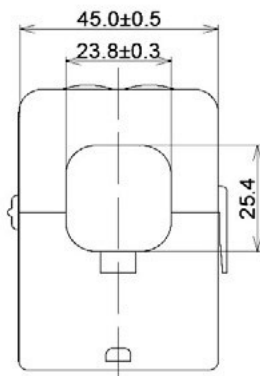

UL1015 22AWG PVC WIRE (600V)

**CS4
(EL0117)**

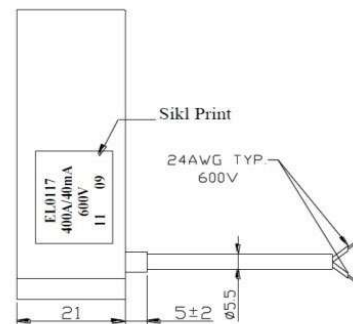
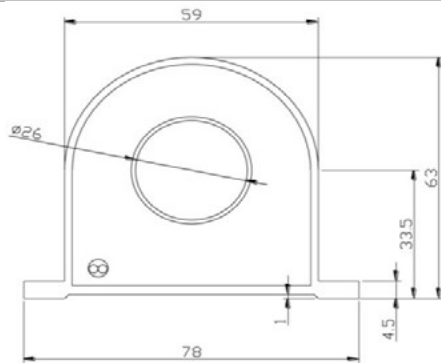

**CS4S
(HX0157)**

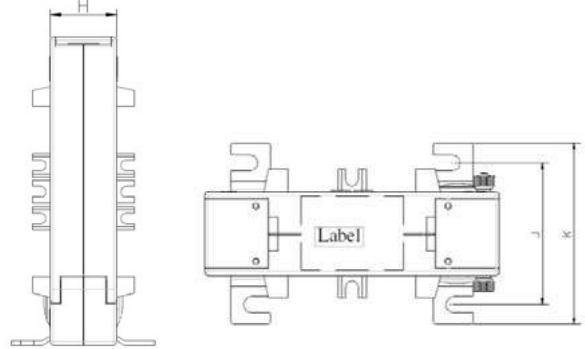
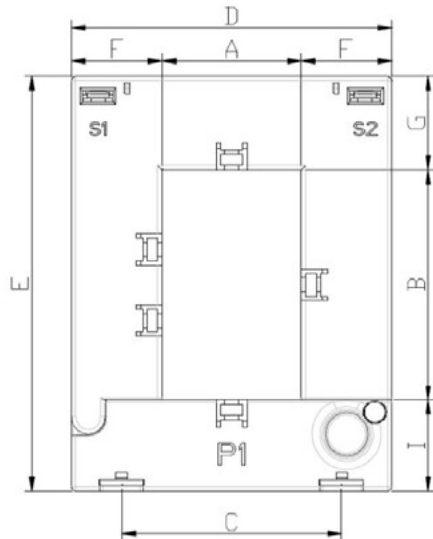

A	B	C	D	E	F	G	H	I	J	K
33	43	45	92	100	29.5	30	28	27	50	65

**CS4L
(EL0153)**

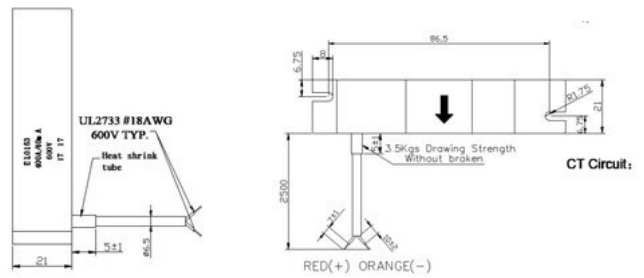
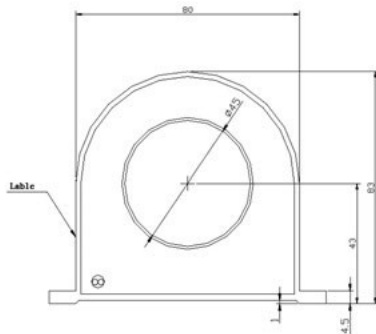

**CS8
(EL0180)**

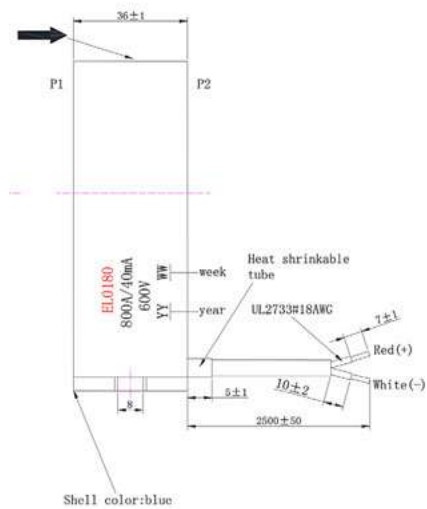
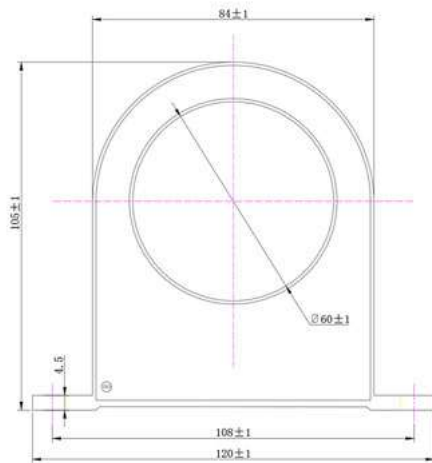



**CS8S
(HX0158)**

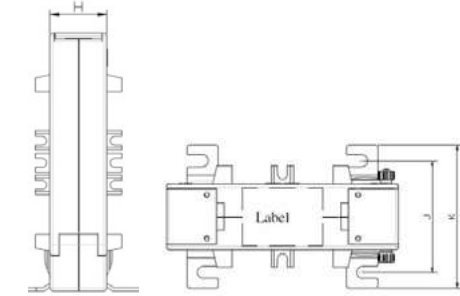
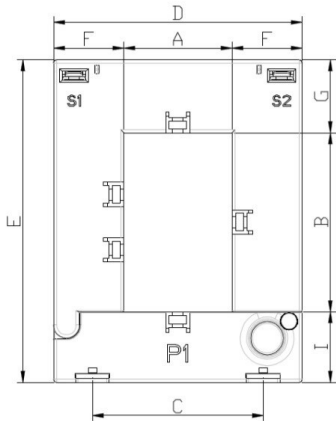

A	B	C	D	E	F	G	H	I	J	K
50	80	78	114	145	32	32	32	33	52.5	67.5

**CS12S
(HX0153)**

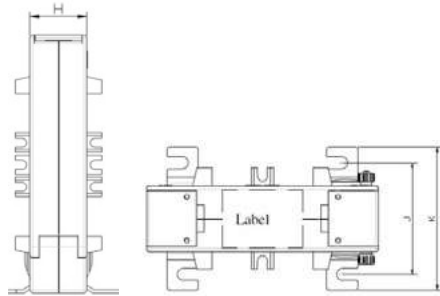
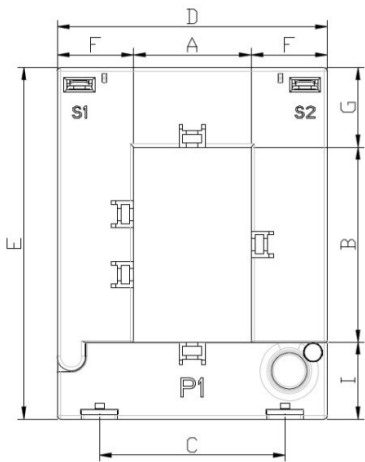

A	B	C	D	E	F	G	H	I	J	K
80	120	108	144	185	32	32	32	33	52.5	67.5

**CS20S
(HX0154)**

**CS30S
(HX0155)**

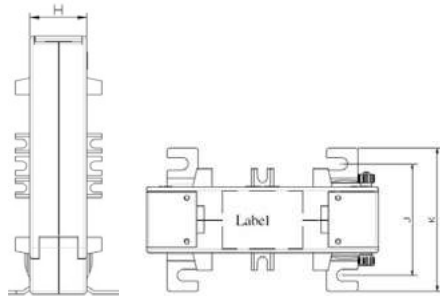
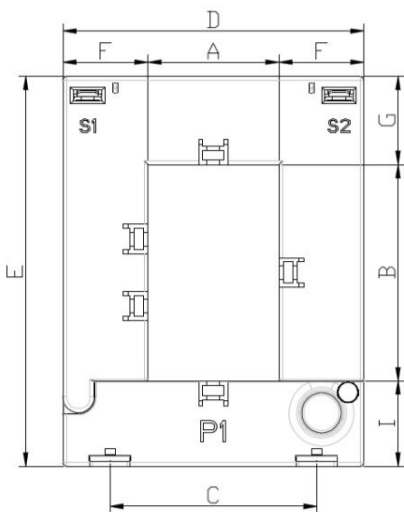

A	B	C	D	E	F	G	H	I	J	K
80	160	120	184	245	52	47	52	38	61	76