



expert**meter**™

High Performance Analyzer

PM180

SATEC PM180 PLC Configurator

Reference Guide

BG0611 REV.A1

Every effort has been made to ensure that the material herein is complete and accurate. However, the manufacturer is not responsible for any mistakes in printing or faulty instructions contained in this book. Notification of any errors or misprints will be received with appreciation.

For further information regarding a particular installation, operation or maintenance of equipment, contact the manufacturer or your local representative or distributor.

REVISION HISTORY

A1	Jan 2018	Initial release
----	----------	-----------------

All trademarks are property of their respective owners

February 2018

Copyright 2017-2018 © SATEC Ltd.

Table of Contents

1 GENERAL.....	5
2 IEC61131 IMPLEMENTATION.....	6
2.1 Limitations.....	6
2.2 Data types.....	6
2.3 Built-in functions	7
2.3.1 AND	7
2.3.2 OR	7
2.3.3 NOT	7
2.3.4 GE.....	8
2.3.5 EQ.....	8
2.3.6 LE8	
2.3.7 GE_THRESHOLD	8
2.3.8 LE_THRESHOLD	8
2.3.9 TON	9
2.3.10 TOF	9
2.4 Function block	9
2.5 Implemented languages	9
2.5.1 Functional block diagram	10
2.5.2 Ladder diagram.....	10
3 PROGRAMMING GUIDE.....	13
3.1 Getting started	13
3.2 Creating project	13
3.3 Adding devices	15
3.4 Device properties.....	16
3.5 Main function block.....	17
3.6 Adding function blocks.....	17
3.7 Setting function blocks.....	18
3.7.1 Rename FB.....	18
3.7.2 Add variables.....	19
3.7.3 Variable properties	19
3.7.4 Add work area	23
3.7.5 Debug FB	23
3.7.6 Delete FB	24
3.8 Communication with the device.....	24
3.8.1 Interfaces	24
3.8.2 Upload configuration to the device	26
3.8.3 Download configuration from the device.....	29
3.9 Functional block diagrams.....	32
3.9.1 Open workspace	32
3.9.2 Add or delete variables	33
3.9.3 Variable properties	34
3.9.4 Add built-in components	34
3.9.5 Making connections	35
3.9.6 Making time delays	37
3.9.7 Programming limits for set point variables.....	38
3.10 Ladder diagrams.....	41
3.10.1 Add ladder diagram	41
3.10.2 Rails	42
3.10.3 Contact	42
3.10.4 Negated contact	42
3.10.5 Coil.....	43
3.10.6 Negated coil.....	43

3.10.7	Creating LD	43
3.10.8	Transformation LD into setpoints.....	47
3.11	Using PLC Configurator with PAS.....	47
4	TROUBLESHOOTING.....	49
4.1	Address in not set.....	49
4.2	Connection error.....	49
4.3	No MAIN module	50
4.4	Unconnected inputs.....	51

1 General

This document specifies a subset of the IEC 61131 standard, particularly part 3 that deals with the languages used to program controllers. The document provides complete information necessary to use SATEC PM180 PLC Configurator (hereinafter referred to as PLC Configurator) in order to program the PM180 device using Functional block diagrams (FBD) and Ladder diagrams (LD) and to communicate with the device. Refer to the PM180 Installation Manual and PM180 Operation Manual for more information on communication connections and configuring communication parameters in your device.

2 IEC61131 Implementation

IEC61131 is the standard relating to programmable controllers. Part 3 of this standard deals with the languages used for programming these devices and is commonly referred as IEC61131-3. SATEC PM180 PLC Configurator implements IEC61131-3 in order to create logic for PM180 devices.

IEC 61131-3 support is limited so that programmable controller system configuration could be compiled to PM180 Setpoints.

2.1 Limitations

Limitations of IEC 61131-3 support are the following:

- Programmable controller system configuration is limited to one task executed at 20ms interval (PM180 hardware limitation). Any program organization unit could be attached to this task.
- Special (nonstandard) *_THRESHOLD functions are used to model analogue values comparison functions of PM180 Setpoints.

2.2 Data types

Data types implemented in PLC Configurator are listed in the table below.

Data type	Description
BOOL	Bit string of 1 bit. Logical state, values are FALSE and TRUE.
LREAL	Long real value (64 bit) $\pm 10^{\pm 308}$, values are from +/-4.19E-307 to +/-1.67E+308.
TIME	Time duration in milliseconds, values are from -T#24d20h31m23s648ms to +T#24d20h31m23s647ms
DATE	Date format, values are from D#1-1-1 to D#65000-12-31, Gregorian For the PM180 device refers to the Packed date data type.
TOD	Time of Day format, values are from TOD#00:00:00.000 to TOD#23:59:59.999 For the PM180 device refers to the Packed time data type.
DT	Date Time format combines DATE and TOD. For the PM180 device refers to the Timestamp data type.
DP	Double point value. There are four possible values: <ul style="list-style-type: none"> • intermediate state (IS) • off state (OFF) • on state (ON) • bad state (BS)

2.3 Built-in functions

Functions are a type of Program Organization Unit. They are small reusable units that form the fundamental building blocks of complex industrial control programs. The implementation contains several built-in functions that are supported by PM180 devices. They are listed in the table below.

Function abbreviation	Function name	Inputs data type	Outputs data type
Logical operations			
AND	AND	ANY_BIT	ANY_BIT
OR	OR	ANY_BIT	ANY_BIT
NOT	NOT	ANY_BIT	ANY_BIT
GE_THRESHOLD	Greater or equal with threshold	LREAL	BOOL
LE_THRESHOLD	Less or equal with threshold	LREAL	BOOL
GE	Greater or equal	ANY	BOOL
EQ	Equal	ANY	BOOL
LE	Less or equal	ANY	BOOL
Time delays			
TON	Timer ON	BOOL, Time	BOOL
TOF	Timer OFF	BOOL, Time	BOOL

2.3.1 AND

AND function returns result of all inputs using logical conjunction. Number of inputs is not limited. AND function is shown in the figure below.

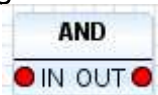

Figure 1 - AND

2.3.2 OR

OR function returns result of all inputs using logical disjunction. Number of inputs is not limited. OR function is shown in the figure below.

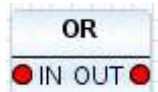

Figure 2 - OR

2.3.3 NOT

NOT function returns result of one input using logical inversion. NOT function is shown in the figure below.

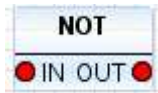

Figure 3 - NOT

2.3.4 GE

GE function returns TRUE if input IN1 greater or equal to IN2.
 GE function is shown in the figure below.



Figure 4 - GE

2.3.5 EQ

EQ function returns TRUE if input IN1 equal to IN2.
 EQ function is shown in the figure below.

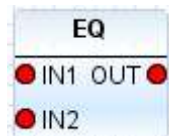

Figure 5 - EQ

2.3.6 LE

LE function returns TRUE if input IN1 less or equal to IN2.
 LE function is shown in the figure below.

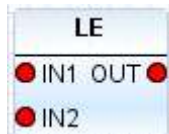

Figure 6 - LE

2.3.7 GE_THRESHOLD

GE_THRESHOLD function returns TRUE if input IN greater or equal to OPERATE and returns FALSE if input IN less or equal to RELEASE.
 In this function IN is a value input, OPERATE and RELEASE are inputs to set threshold. Usually to set threshold locale variables are used.
 GE_THRESHOLD function is shown in the figure below.

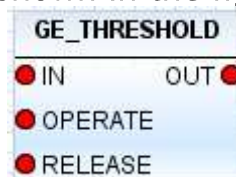

Figure 7 - GE_THRESHOLD

2.3.8 LE_THRESHOLD

LE_THRESHOLD function returns TRUE if input IN less or equal to OPERATE and returns FALSE if input IN greater or equal to RELEASE.
 In this function IN is a value input, OPERATE and RELEASE are inputs to set threshold. Usually to set threshold locale variables are used.

LE_THRESHOLD function is shown in the figure below.



Figure 8 - LE_THRESHOLD

2.3.9 TON

TON function is used for making time delays.

TON function returns TRUE if input IN changes from FALSE to TRUE with the delay set via input PT.

In this function IN is control input (BOOL), input PT is used for setting time delay in milliseconds.

TON function is shown in the figure below.



Figure 9 - TON

2.3.10 TOF

TOF function is used for making time delays.

TOF function returns FALSE if input IN changes from TRUE to FALSE with the delay set via input PT.

In this function IN is control input (BOOL), input PT is used for setting time delay in milliseconds.

TOF function is shown in the figure below.



Figure 10 - TOF

2.4 Function block

Function Block (FB) is a type of Program Organization Unit. It has set of input variables and output variables. Each block has an algorithm, which enables evaluation of all its inputs and produces set of output values. Unlike functions, function blocks also have temporary variables, which store intermediate values during its evaluation. The execution of a function block can also depend on its own output in a previous instance of execution.

Function block can include build-in functions.

2.5 Implemented languages

There are two graphical languages implemented in PLC Configurator:

- Function Block Diagram (FBD).
- Ladder Diagram (LD).

2.5.1 Functional block diagram

Function Block Diagram (FBD) is a programming language defined in IEC61131-3. FBD is a graphical representation of an Industrial programmed control system and adopts a set of symbols and conventions defined in IEC-1131-3. It represents a control system in terms of signal flow between processing elements similar to the methodology adopted for signal flow in electronic circuits. By using interconnected graphical blocks, it expresses the behavior of functions, function blocks and a composite program.

An example of FBD is shown in the figure below.

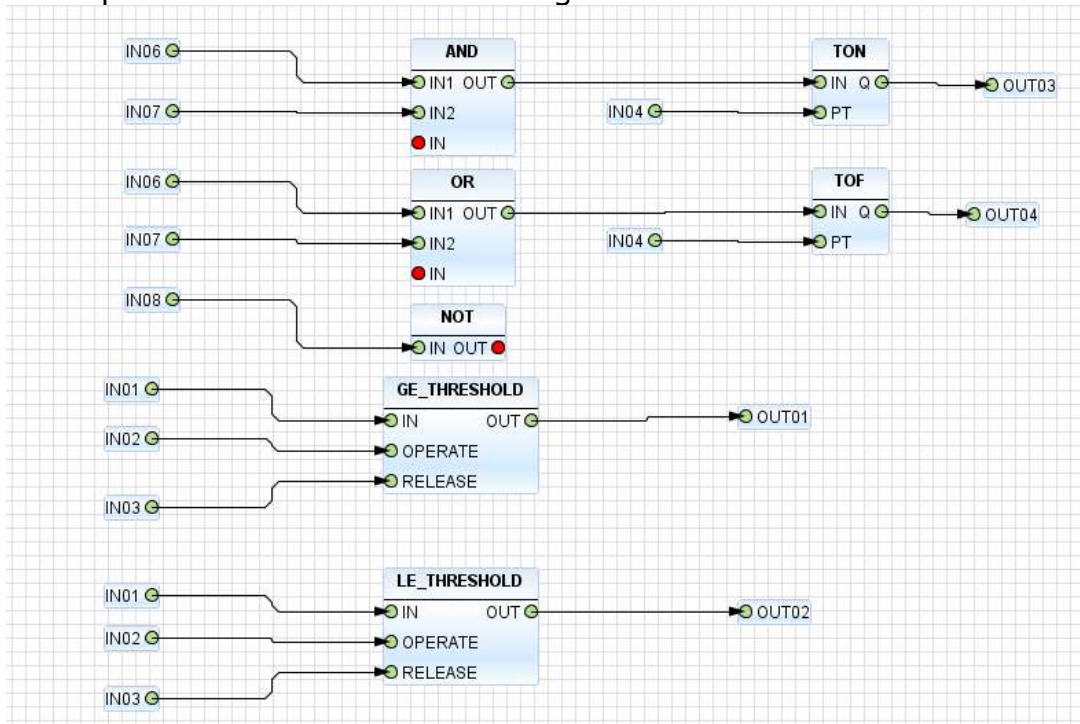

Figure 11 – FBD

You can find detailed information about creating FBD in PLC Configurator in chapter 3.9.

2.5.2 Ladder diagram

Ladder Diagram (LD) is a programming language defined in IEC61131-3. Ladder diagrams are derived from electrical circuit diagrams, which have been conventionally used to represent relay logic operations. Many of the symbols and terminology have also been adopted from the circuit diagrams. In other words, Ladder Diagrams are graphical representations of Boolean expressions, but they can also include other information normally not possible with Boolean expressions.

A ladder diagram has two vertical power rails, one on the left and another on the right side of the diagram. The left vertical rail carries the power to the coil (notionally) through the contacts. The contacts are arranged along horizontal 'rungs' and the power flows through these rungs to energize the coil, which is on the right hand side of the logic diagram, when the logic condition represented by the contacts is TRUE

(AND logic). Alternative paths can be present with other contacts in them (in parallel), which can be used to build OR logic. An example of ladder diagram is shown in the figure below.

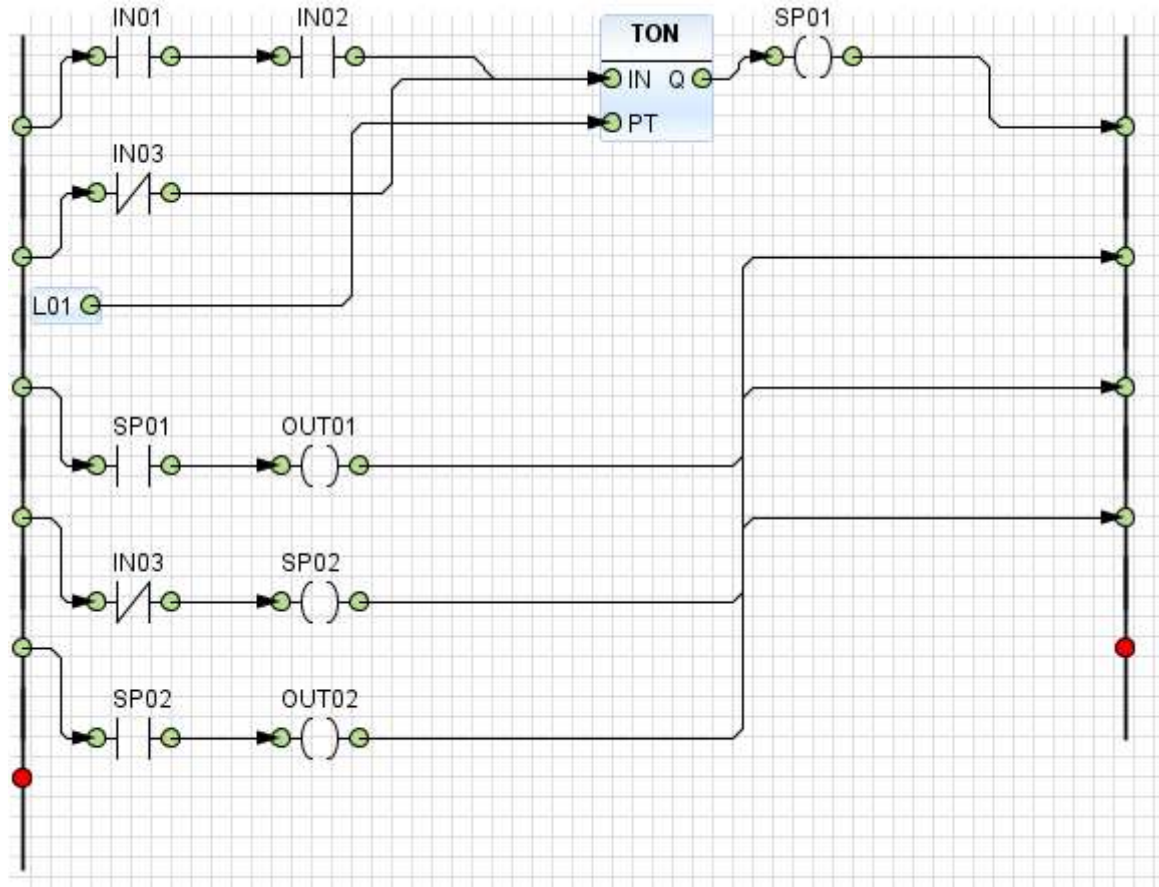

Figure 12 - LD

Basic concepts of LD implemented in PLC Configurator are the following:

- There are two rails: left rail (so called "+" rail) and right rail (so called "-" rail).
- Between rails can be contacts and one coil. They are situated along horizontal so called "rung".
- Contacts represent BOOL input variables, whereas coils represent BOOL output variables.
- There are two types of contacts and coils: normally closed and normally opened.
- Serial connection of contacts is used to create AND logic.
- Parallel connection of contacts is used to create OR logic.
- If all the contacts on the way from the left rail to a coil are closed, the coil is energized and its state is TRUE.
- Coils can have their own contacts like shown in the figure below.

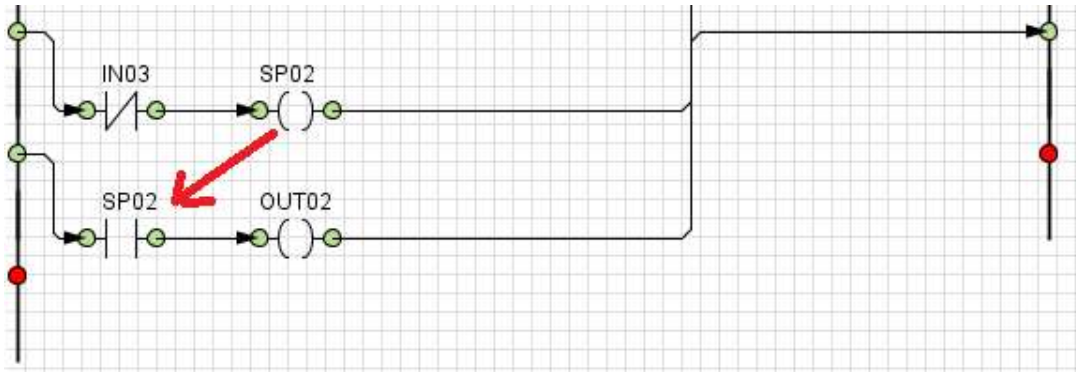

Figure 13 – Coil's contact

- To create more complex logic it is possible to add built-in functions and variables of other from BOOL data types.

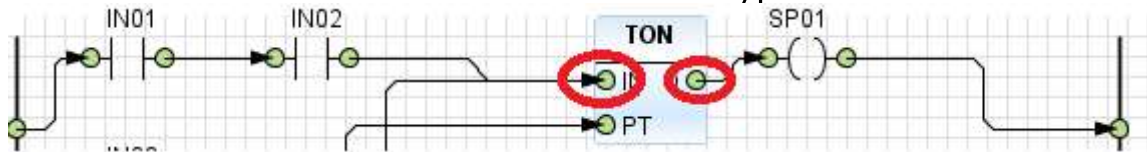

Figure 14 - Using TON function in LD

You can find detailed information about creating LD in PLC Configurator in chapter 3.10.

3 Programming guide

3.1 Getting started

Before starting PLC Configurator, be sure you have installed **Java 8** 64 bit on **Windows 7** and above (64 bit versions only).

To start PLC Configurator:

1. Unzip the archive with the application in any folder.
2. Run file "bin/scadastudio.exe".

3.2 Creating project

To create new project:

1. Start PLC Configurator application.
2. In the application, choose File -> New Project, like shown in the figure below.

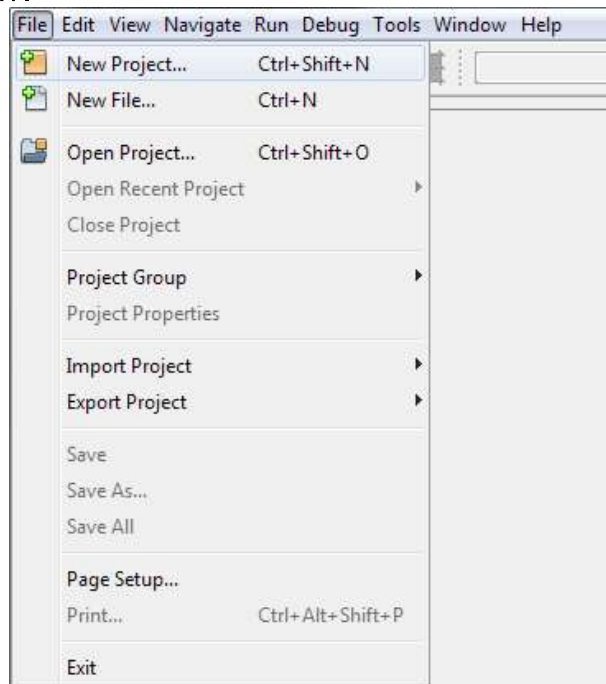

Figure 15 - File menu

3. In the New Project wizard, expand the SATEC category and select SATEC PLC Project like shown in the figure below. Then click Next.

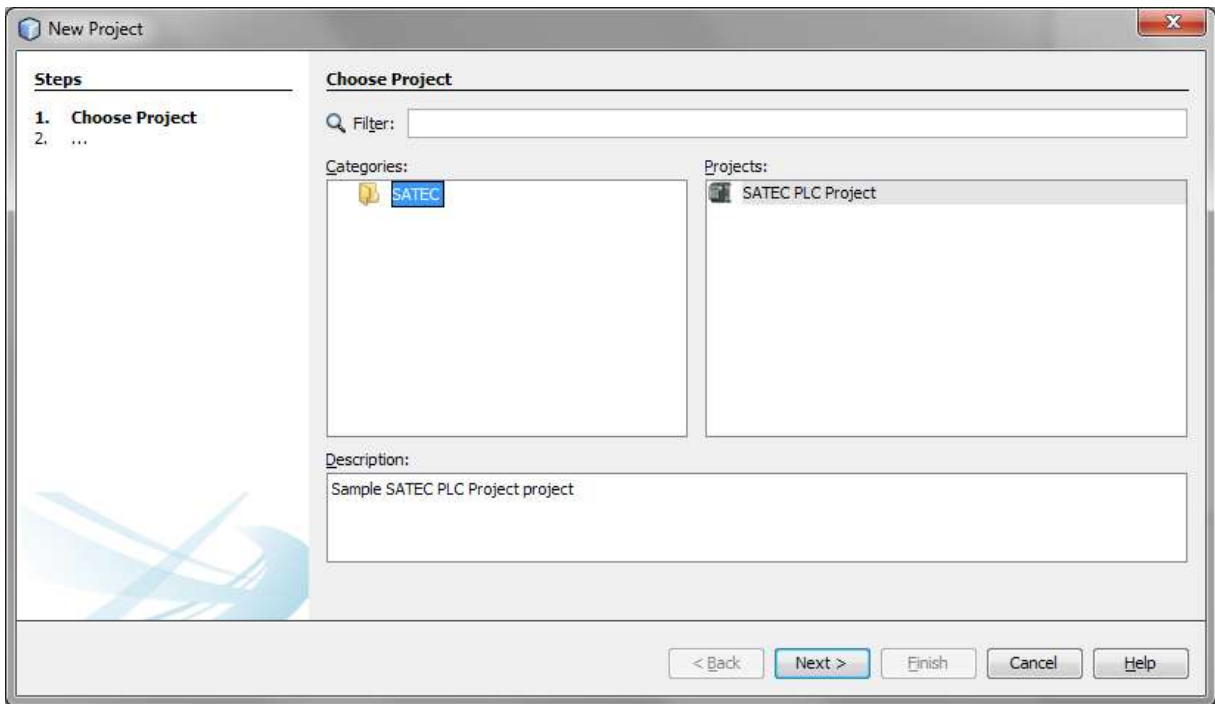

Figure 16 - Project choosing

4. In the Name and Location page of the wizard, do the following (like shown in the figure below):
 - In the Project Name field type project name.
 - To setup project location click on *Browse...* button or type it in the Project location field.

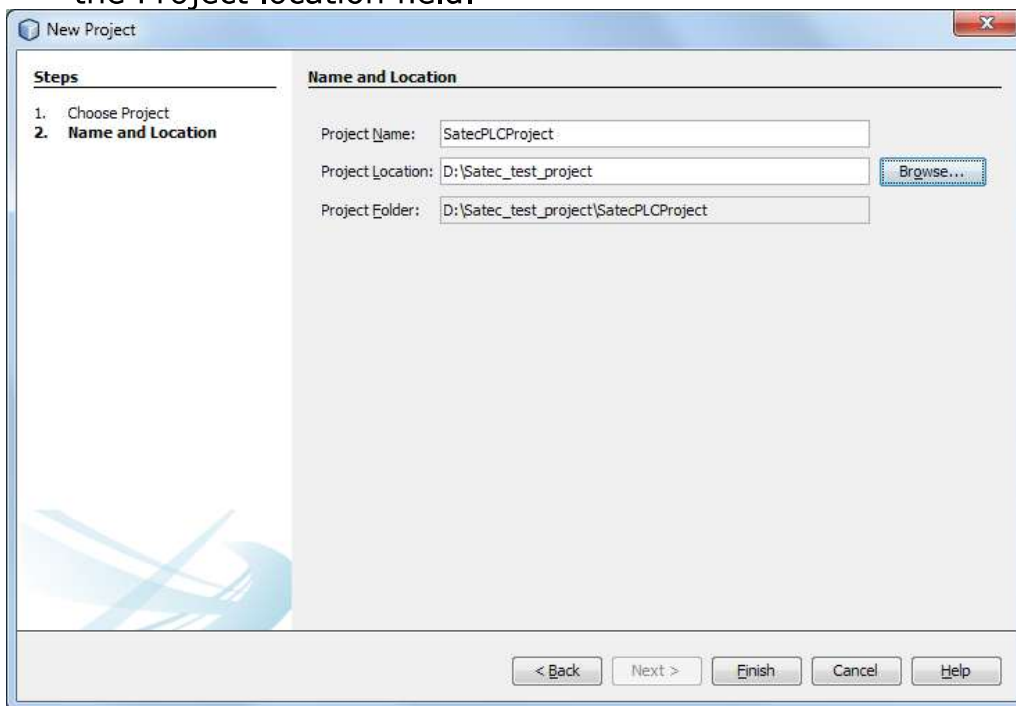

Figure 17 - Name and Location

5. Click Finish.
After that the project will be created and opened in PLC Configurator.
You should see the following components:

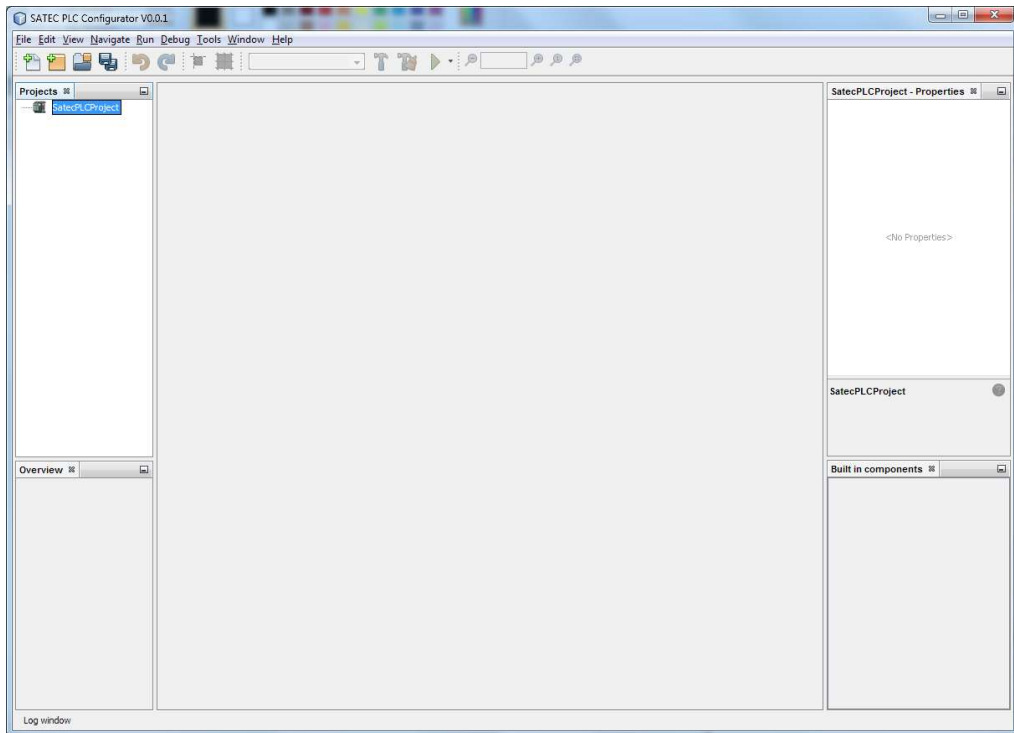

Figure 18 - Created project

3.3 Adding devices

To add new devices do following:

1. Click the right mouse button on the existing project.

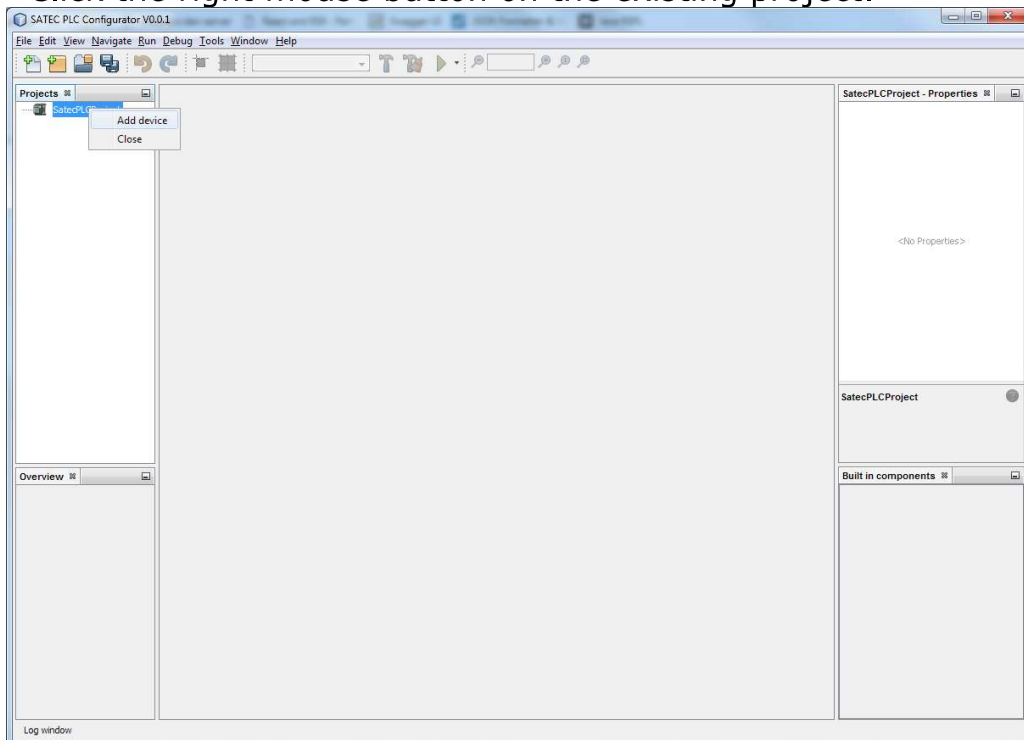

Figure 19 - Add device menu

2. Select Device and Language in the "Add a new device" window and click Ok.
Choose the type of diagram you want to use (Language):

- FBD (Function Block Diagram).
- LD (Ladder Diagram).

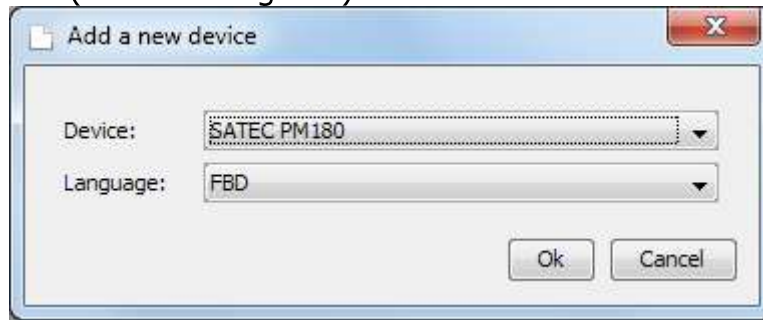

Figure 20 - Device properties

After that you will see a newly created device in the project tree.

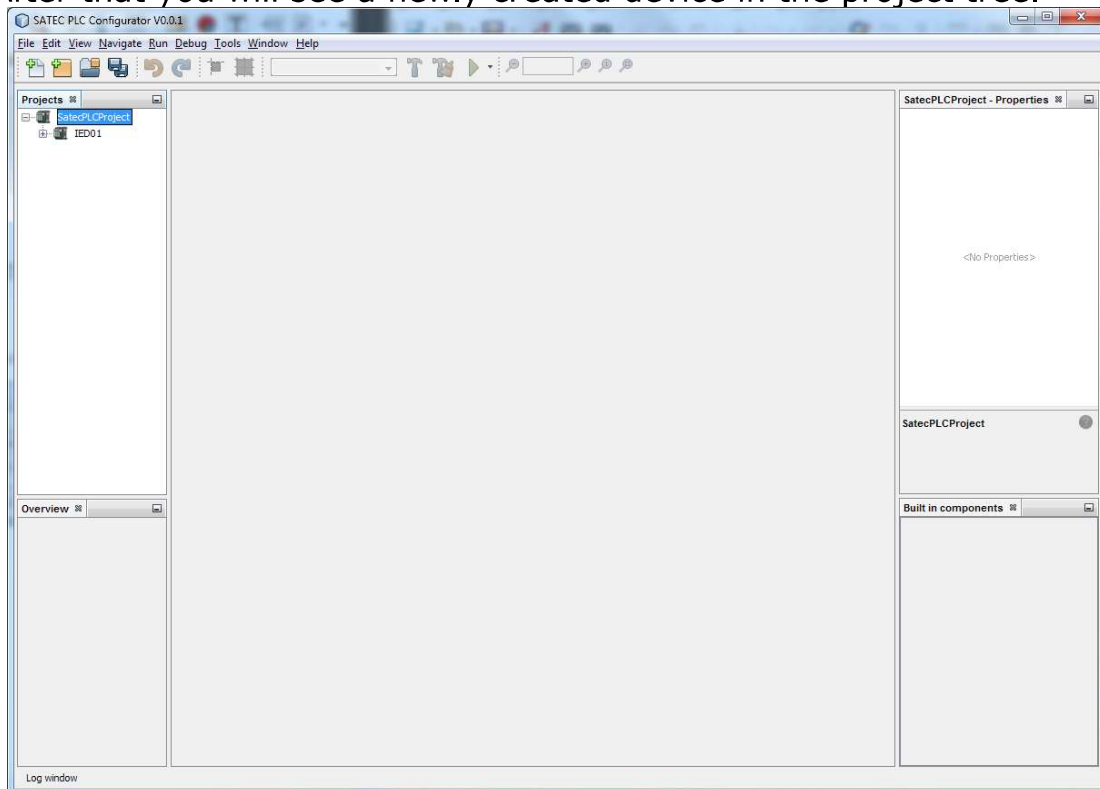

Figure 21 - Created device in the project

3.4 Device properties

To open device properties double-click on a device in the project tree. The properties will appear in the middle of the screen:



Figure 22 - Device properties

You can set the following settings:

1. "Release coefficient in comparison operations" – for details see 3.9.7.

2. "Settings range for the logic generator" – here you can set the range of set points that will be used on the PM180 device, during automatic logic generation. For detailed information see 3.11.

3.5 Main function block

A newly created device contains one function block named MAIN.

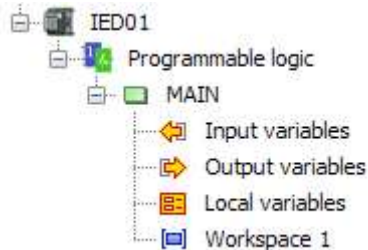



Figure 23 - Main function block

Main function block must be in every device. This block is sent to the device when you use function "Send configuration to the device" (see 3.8.2). If you don't have main function block in your device you will get an error (see 4.3).

 Note that if you add new function blocks to the device (see 3.6) you have to use them in the Main function block otherwise that logic will be ignored during uploading procedure.

3.6 Adding function blocks

To add additional function (FB) block do the following:

1. Click the right mouse button on the section "Programmable logic" of the device and choose "New function block".

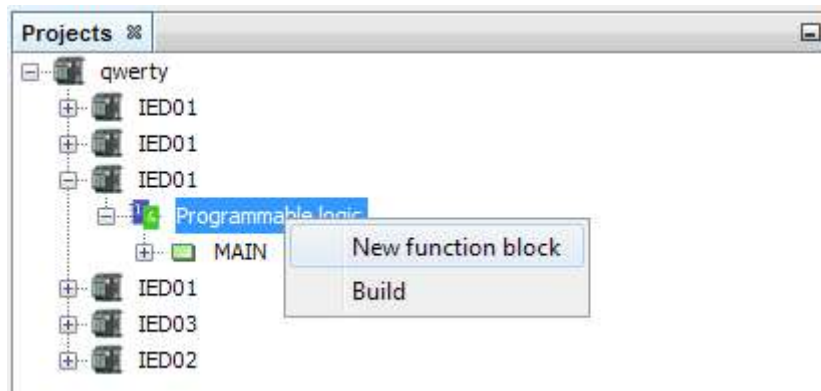
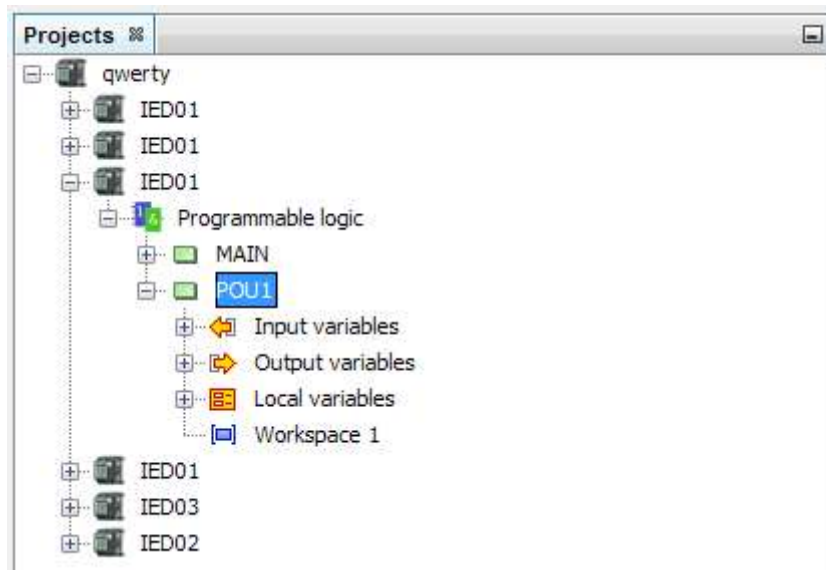

Figure 24 - Add new function block

2. A new block named "POU" will appear in the project tree.



3.7 Setting function blocks

3.7.1 Rename FB

To rename FB click the right mouse button on FB in the project tree and choose "Rename".

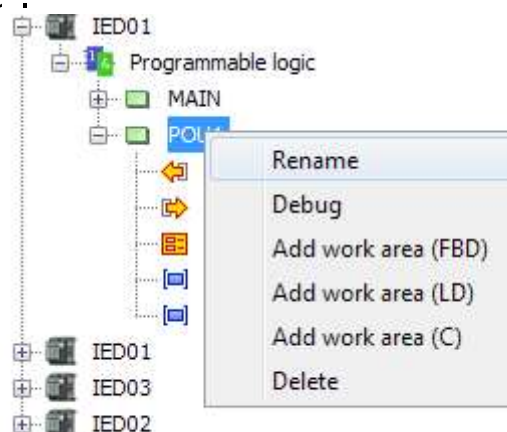

Figure 25 - Rename FB

Type the new name in appeared window like shown in the figure below and click OK.

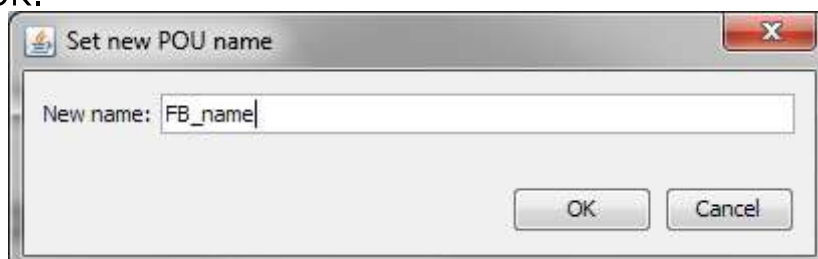

Figure 26 - FB new name

In the following window confirm your action and click Ok. The FB will be renamed.

3.7.2 Add variables

To add variables click the right mouse button on one of the following sections depending on the type of variable you want to add:

1. Input variables.
2. Output variables.
3. Local variables.

Context menu will appear like shown in the figure below:

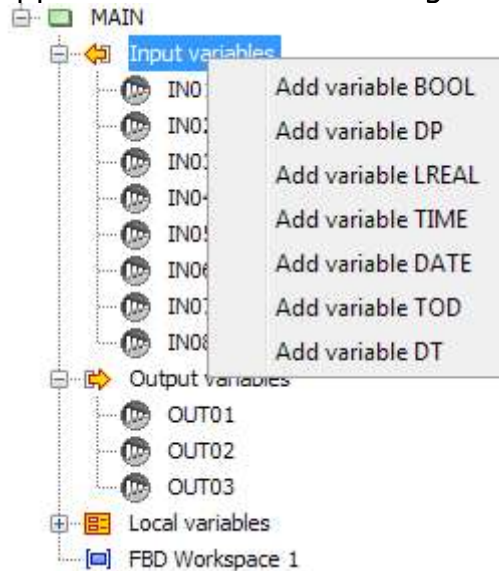

Figure 27 - Adding variables

In the menu choose the desired type of variable and click on it with the left mouse button. A new variable will be added.

! You can use the same input or local variable many times on the same diagram. It can simplify visual perception of your project.

3.7.3 Variable properties

When you click on a variable in a FB tree its properties appear on the right hand side of PLC Configurator (by default) like shown in the figure below.

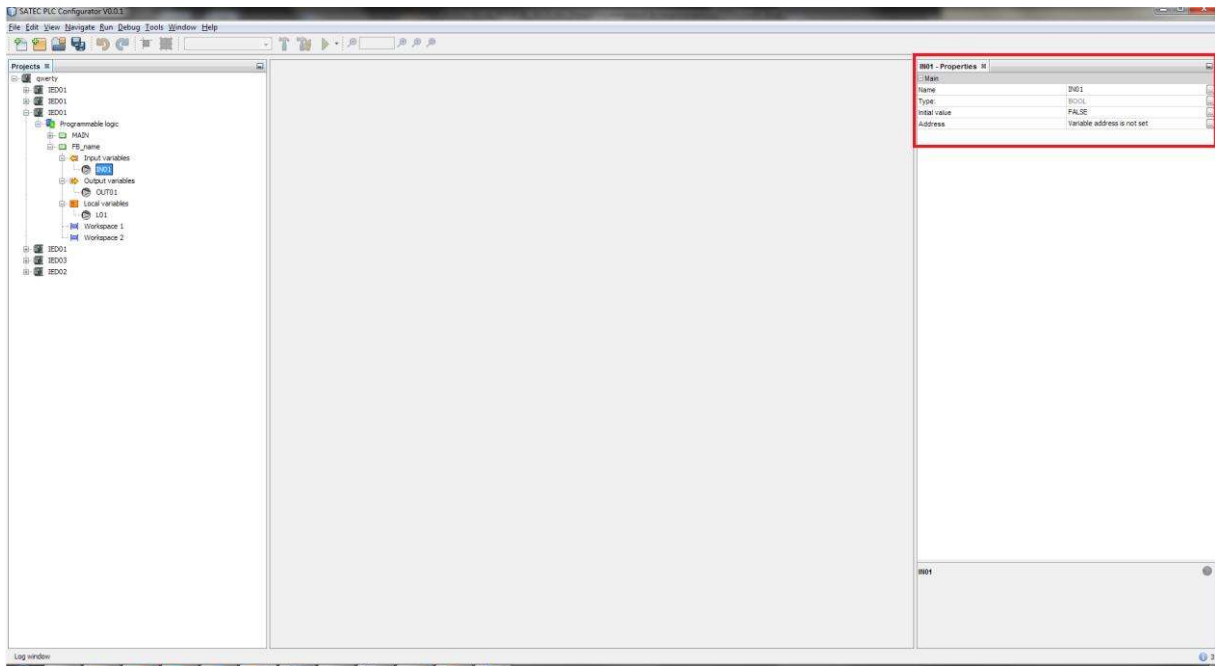

Figure 28 - Variable properties

You can set properties using Properties component.

There are following properties:

1. Name – name of a variable.
2. Type – type of a variable. Cannot be changed.
3. Initial value – a value that variable has before it is changed due to signal flow.
4. Address – mapping variables to the PM180 internal variables such as digital inputs, relay outputs, set points, etc. Local variables don't have such setting.



Please note that in order to operate on the PM180 device every input and output variable of FB must be mapped to the device internal variables otherwise you will get a message "Variable address is not set" during uploading the configuration to the device.



Be advised that PLC Configurator automatically distributes set points according to the device property "Settings range for the logic generator". To set this setting, see 3.4. We discourage you from mapping output variables to set points, because PLC Configurator does it automatically anyway. In case of manual mapping output variables to set points you can get errors concerning execution sequence of function blocks. In other words, logic that you made in PLC Configurator can be executed in a different way on the device and the result that you get will be different.

To set the address, click on  icon in the Address setting. Depending on the type of variable one of the following windows will appear:

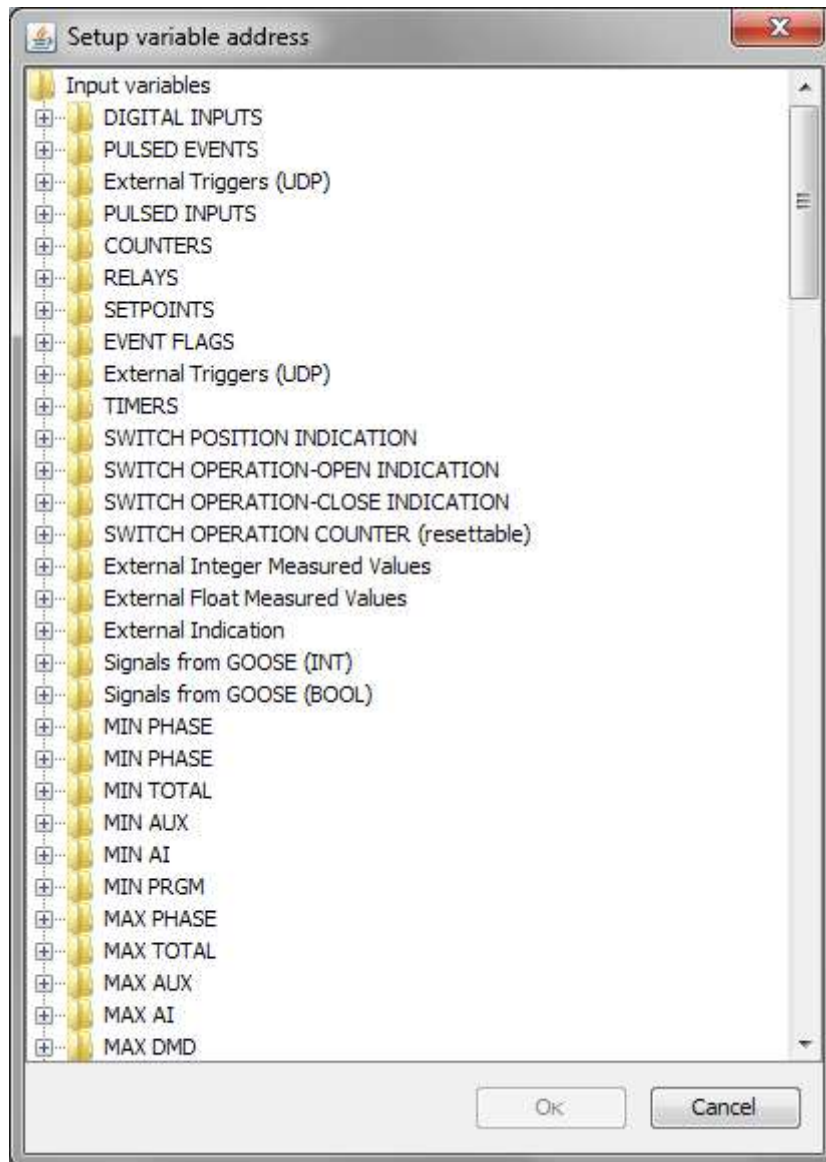

Figure 29 - Input variables mapping

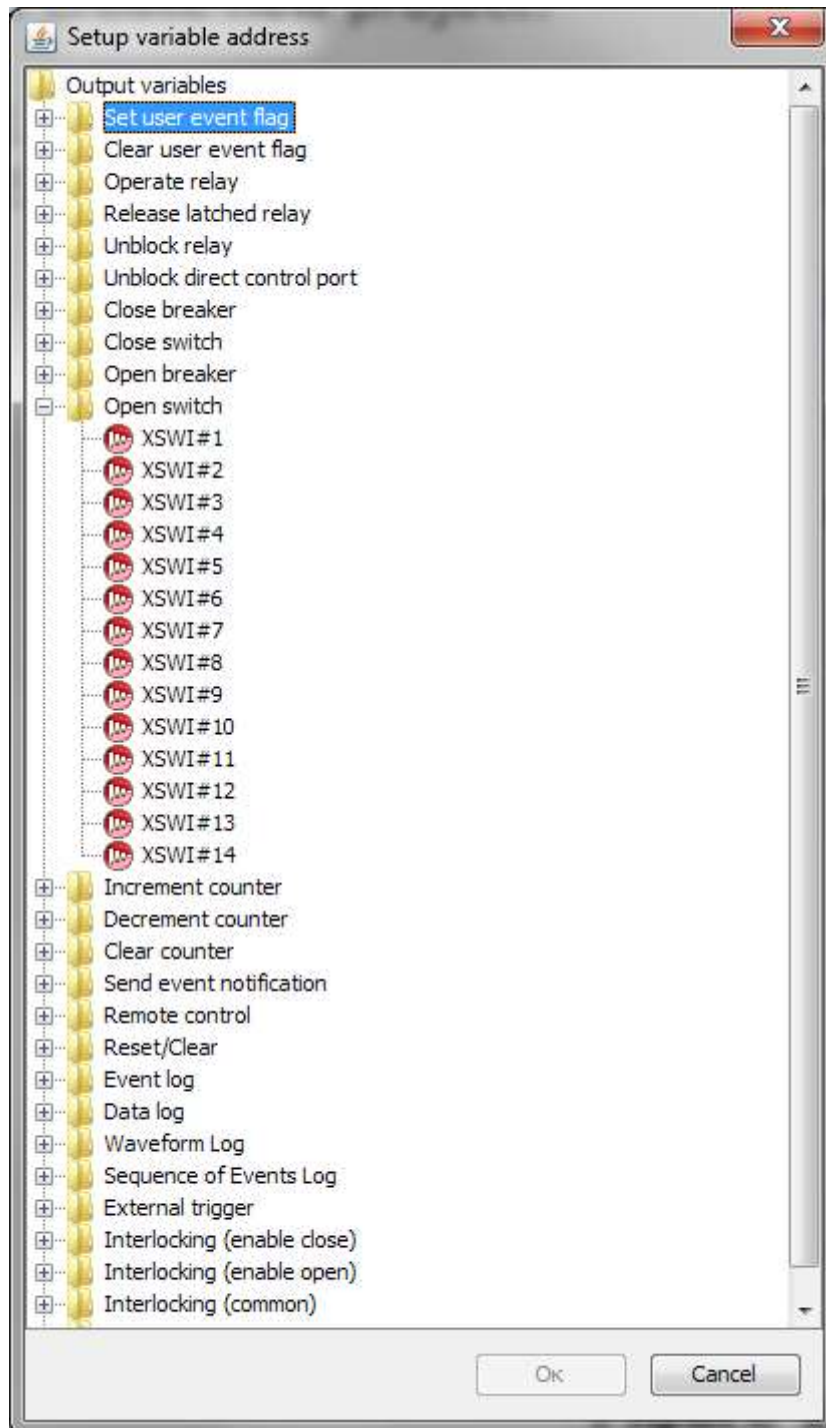

Figure 30 - Output variable mapping

For input variables set an internal device signal that will be a source of input variable (digital input, relay output, event flag, etc.).

For output signal set an action that will be accomplish when the input has the proper value.

In any case you should expand desired folder and choose variable you want to map and then click on Ok.

! Please note that you can choose addresses with corresponding type only, other addresses in the «Setup variable address» are marked in

grey color and unavailable for choosing like shown in the figure below. Variable's type is shown in the Properties window.

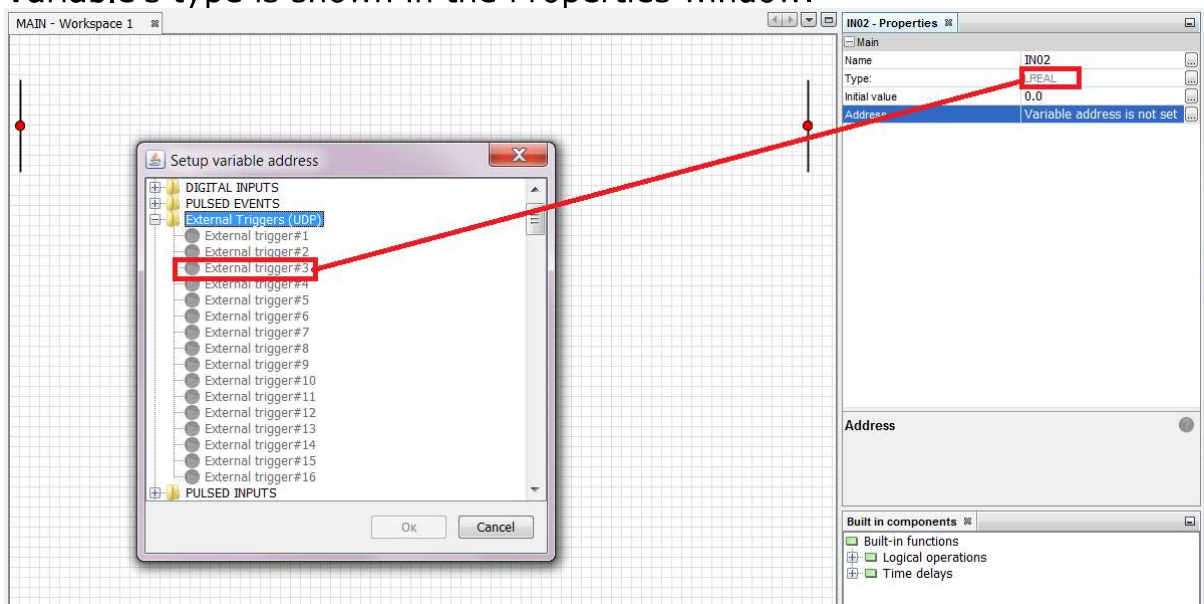

Figure 31 - Variables with unsupported types

The chosen internal variable will appear in the Address setting. You can rename or delete properties using its context menu.

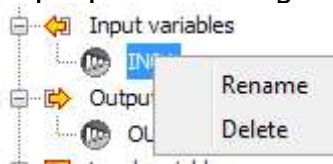

Figure 32 - Variable context menu

3.7.4 Add work area

To add additional work area click on FB with the right mouse button and choose one of the following options, depending on the diagram you are using on the device:

1. Add work area (FBD).
2. Add work area (LD).

New work area will be added and will appear in the FB tree.

3.7.5 Debug FB

Debugger is used if you want to check the logic of FB that you created or search for mistakes.

To debug FB choose Debug in the context menu of FB. Debugger will appear like shown in the figure below:

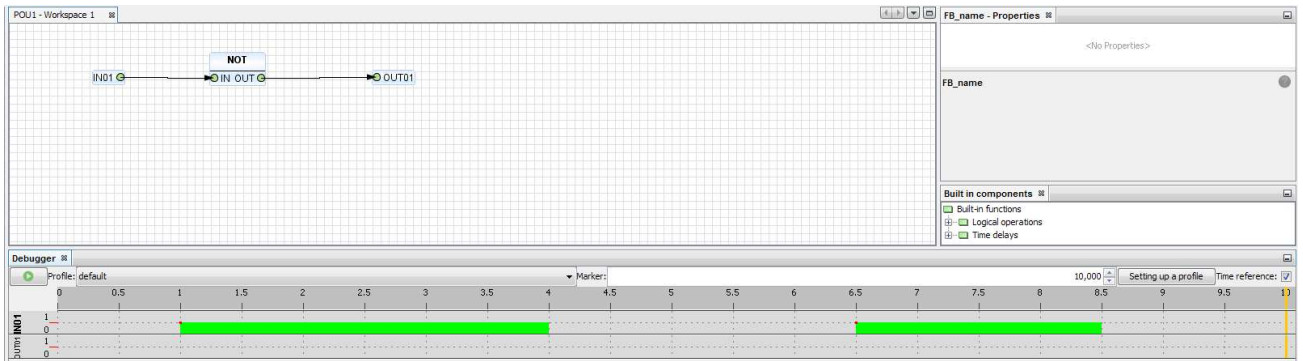



Figure 33 - Debugger

You can set input or local variables by clicking on them with the left mouse button.

When you press  button, output values will appear on the lines corresponding to output variables like shown in the figure below.

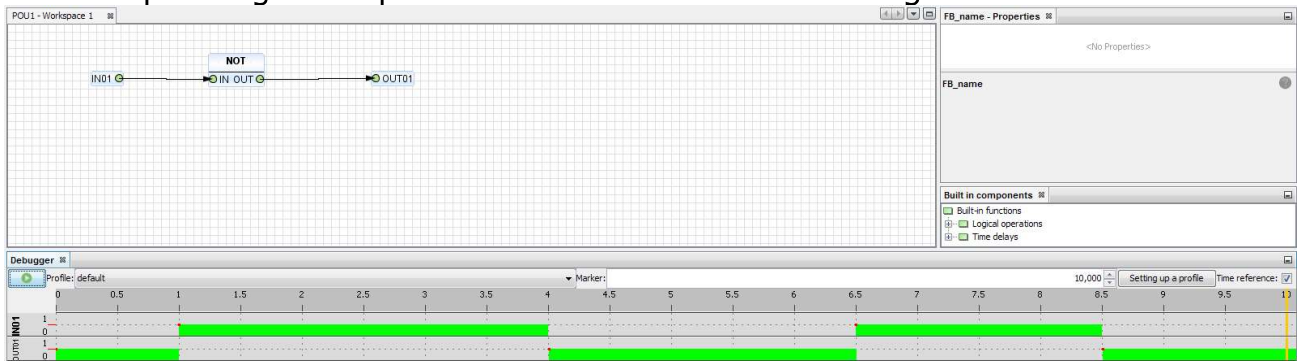

Figure 34 - Debug result

3.7.6 Delete FB

To delete FB click on FB with the right mouse button and choose Delete option. Confirm your action in the following window pressing "OK". The FB will be deleted.

3.8 Communication with the device

3.8.1 Interfaces

PCL Configurator supports communication with PM180 device via USB, Serial port or Ethernet (TCP/IP).

1. To connect via USB you need to plug in USB cable to PM180 USB port 1.1.

It uses PM180 MODBUS RTU protocol (12 Mb/s) for fast local communications and data retrieving.

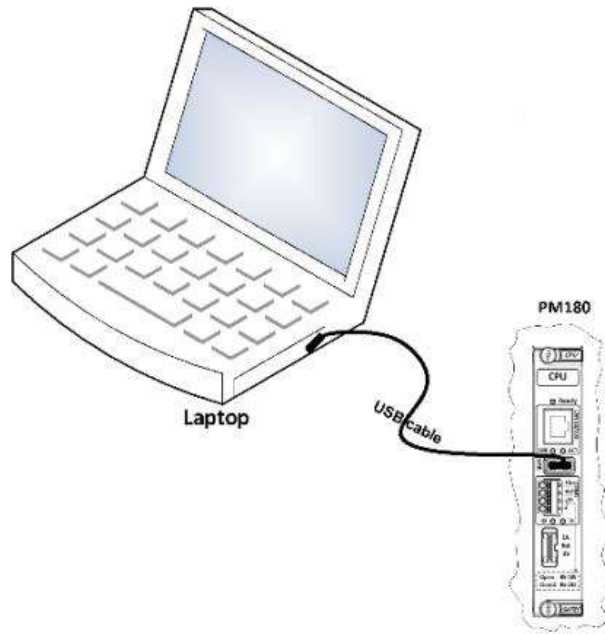

Connection – USB device

2. To connect via Serial port you need to use serial communication port COM1 with cable suited for RS232/485.

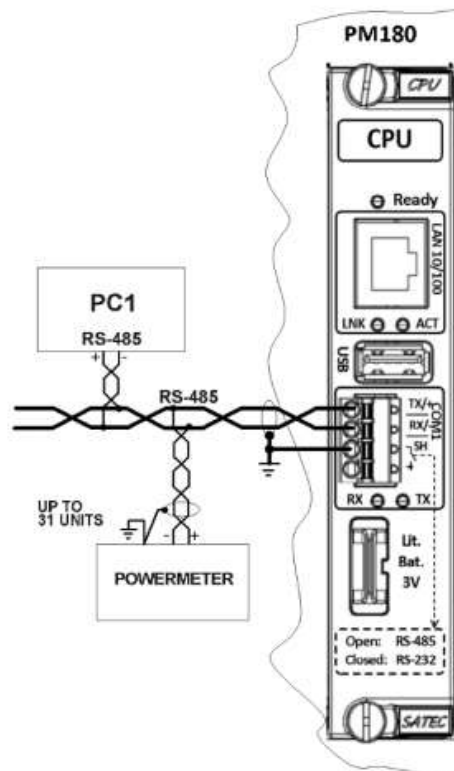

Communication Network Connection

3. Ethernet connection

Ethernet connection option is provided by one 10/100TX Ethernet communication port on the CPU module. Use RJ45 Cable with "Straight Through" wiring.

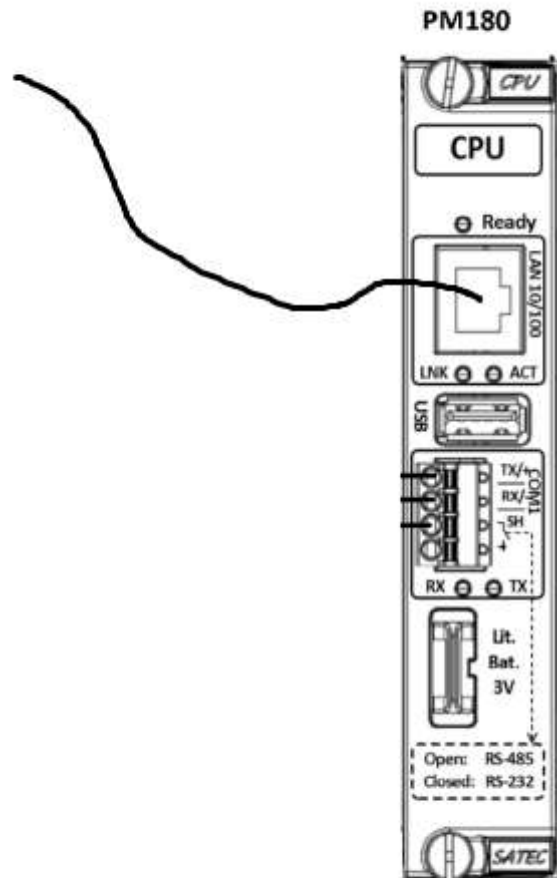

Communication Network Connection

3.8.2 Upload configuration to the device

Before you start, need to create a new project or open the existing one. In addition, your project must contain at least one device and you PC must be connected to the PM180 device by any of interfaces. Before uploading PLC Configurator reads current Ration settings from the device and evaluates constants that are used in the logic you want to upload.

! Please note that you must set all analog values for variables in SI units only (V, A, W, etc.), otherwise the logic you upload will be working incorrectly.

To upload configuration from the device do the following:

1. Click the right mouse button on a device and select "Send configuration to the device" from padding menu.

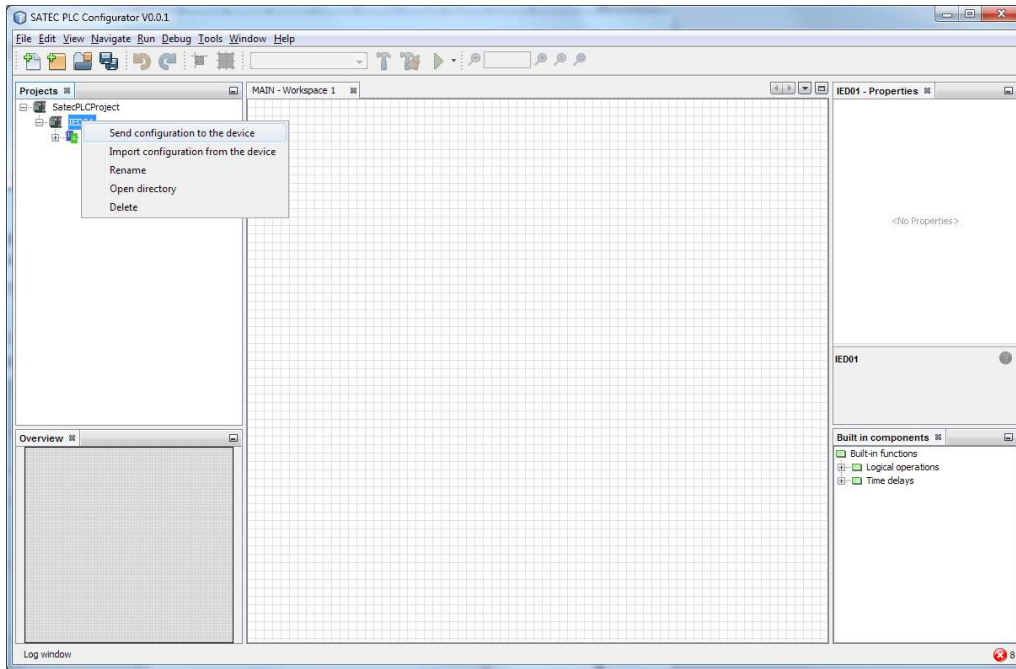

Figure 35 - Context menu

2. After that you will see the upload page.

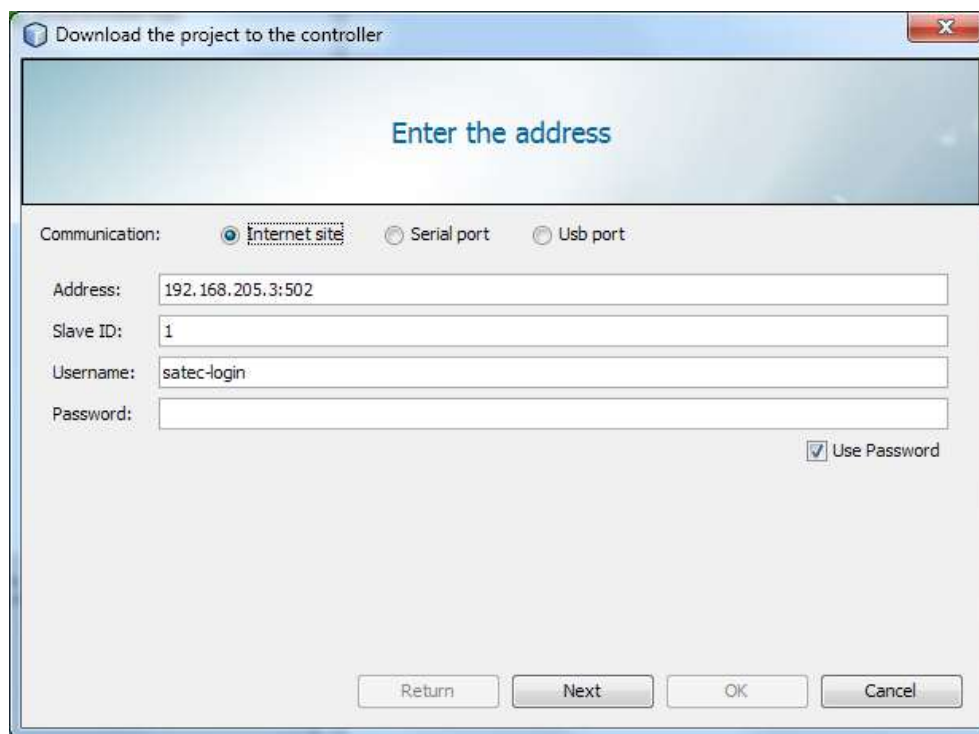

Figure 36 – Internet site settings

There are 3 types of communication interfaces.

1. Internet site

To upload using TCP/IP you have to select Internet site radio button and type in address like this:

IP address:Port

Also you have to know a Slave ID of your destination device.

2. Serial Port

To upload via Serial port you need to select Serial port radio button and set properties to meet the serial port settings of the PM810 device.

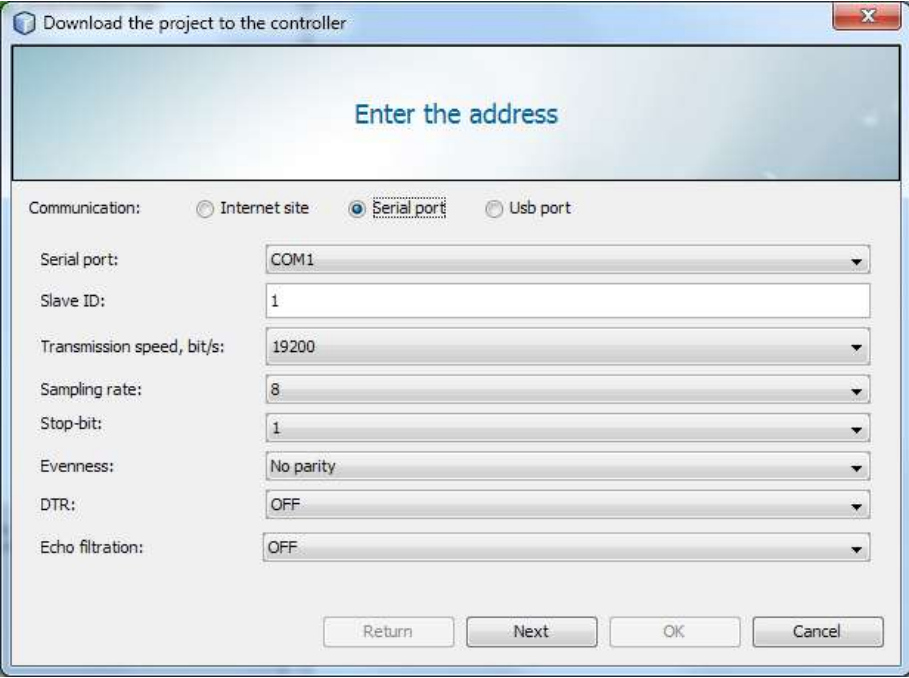

The screenshot shows a dialog box titled "Download the project to the controller" with a close button (X) in the top right corner. The main heading is "Enter the address". Under the "Communication:" section, three radio buttons are present: "Internet site" (unselected), "Serial port" (selected), and "Usb port" (unselected). Below this, several settings are listed in a table-like format:

Serial port:	COM1
Slave ID:	1
Transmission speed, bit/s:	19200
Sampling rate:	8
Stop-bit:	1
Evenness:	No parity
DTR:	OFF
Echo filtration:	OFF

At the bottom of the dialog box, there are four buttons: "Return", "Next", "OK", and "Cancel".

Figure 37 – Serial port settings

3. USB port

To upload via USB port you need to select USB port radio button and type in "Slave ID" of the PM180 device.

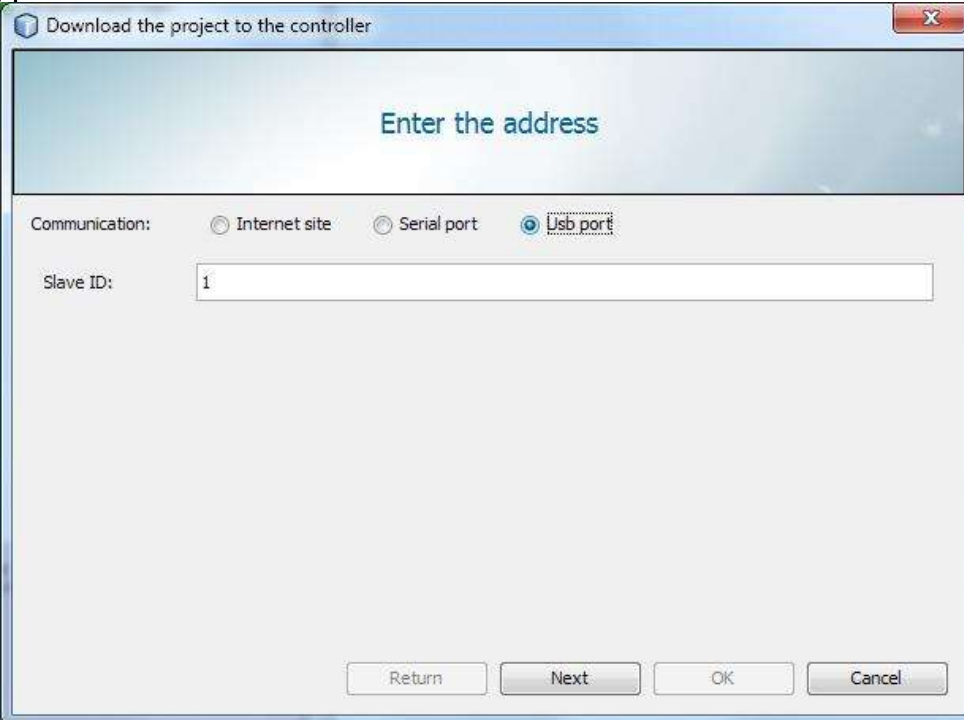

The screenshot shows the same dialog box as Figure 37, but with the "Usb port" radio button selected. The "Serial port" radio button is now unselected. The "Slave ID" field contains the value "1". All other settings and buttons remain the same as in Figure 37.

Figure 38 - USB port settings

After that, your project will be built and you will see the log page:

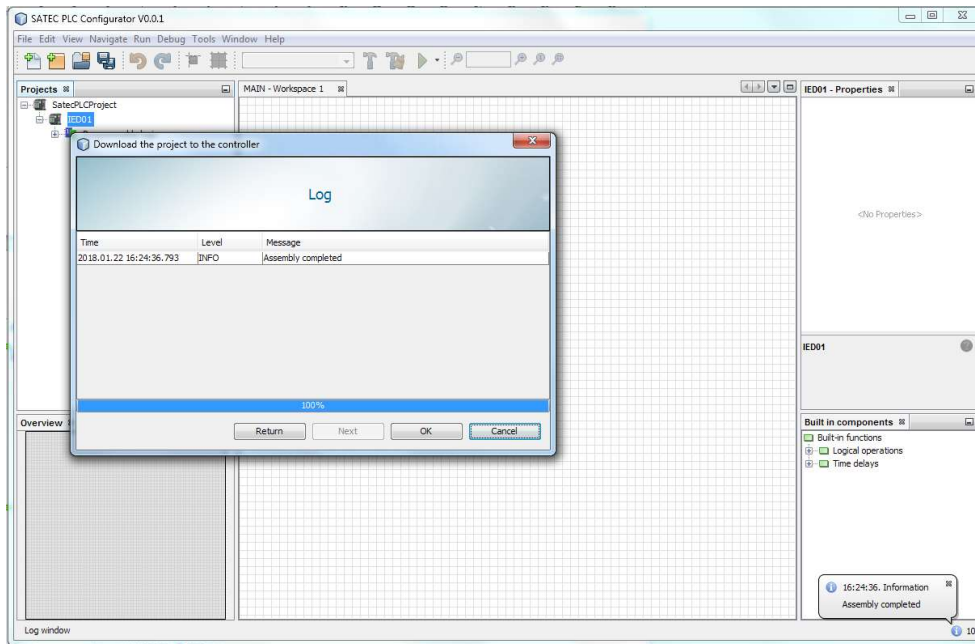

Figure 39 - Building log

In case of successful uploading you will see “Loading complete” message in the right bottom corner of the application.

3.8.3 Download configuration from the device

Before you start, you need to create a new project or open the existing one. In addition, your project must contain at least one device and you must be connected to the PM180 device by any of interfaces. To download configuration from a device do the following.

Click the right mouse button on a device and select “Import configuration from the device” from padding menu.

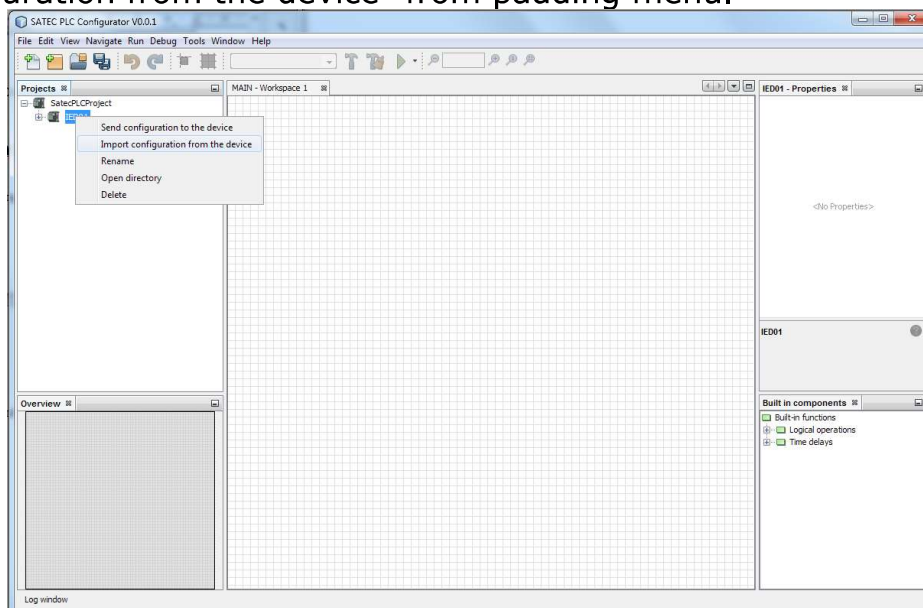

Figure 40 - Import menu

After that you will see the download page.

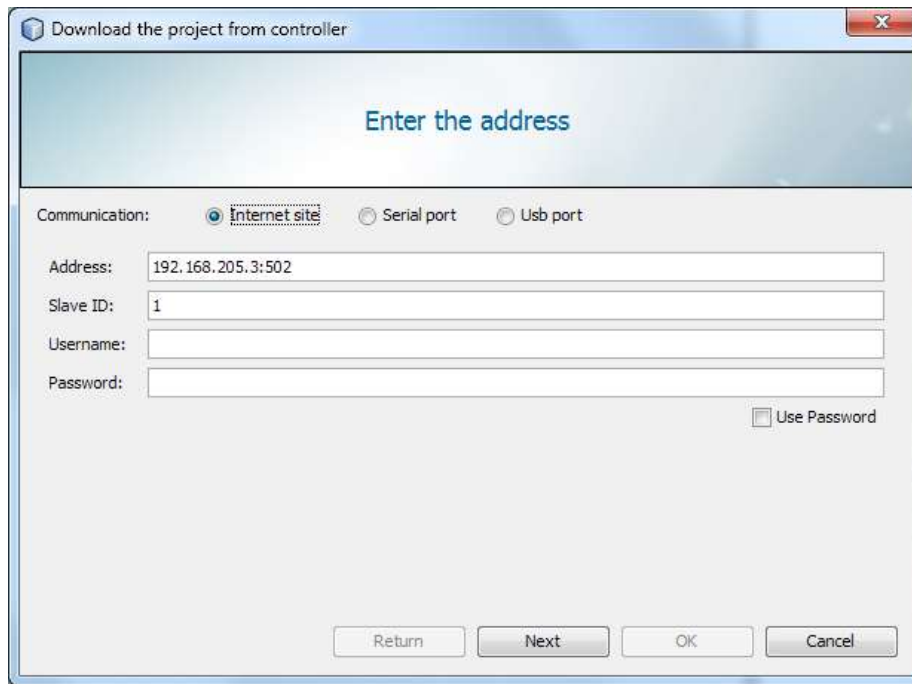

Figure 41 - Internet page

There are three types of communication interfaces.

1. Internet site

To download via TCP/IP you need to select Internet site radio button and type in address like this:

IP address:Port

Also you have to know a Slave ID of your destination device.

2. Serial port

To download via Serial port you need to select Serial port radio button and configure properties to meet the settings.

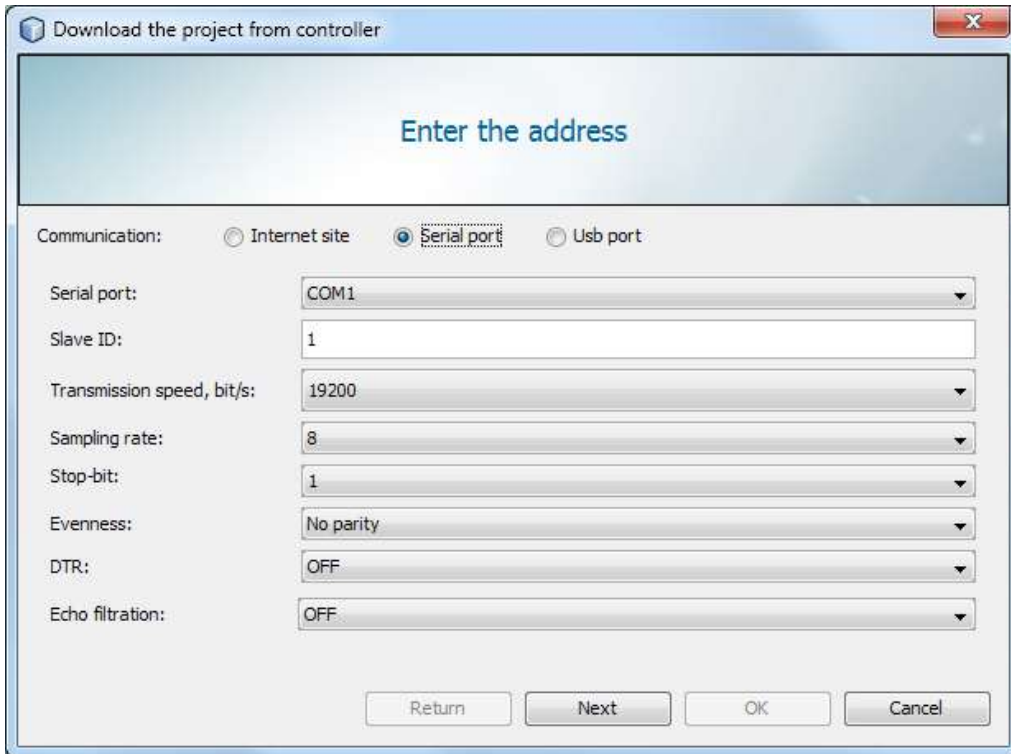

Figure 42 - Serial port

3. USB port

To download via USB port you need to select USB port radio button and type in "Slave ID" of the PM180 device.

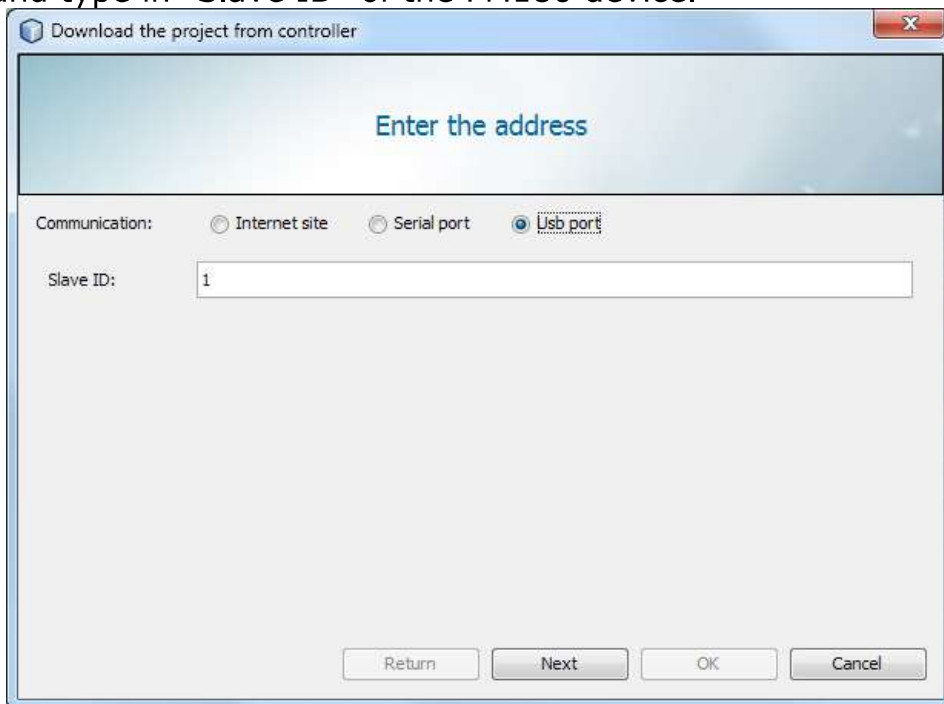

Figure 43 - USB port

After that you will see the log page:

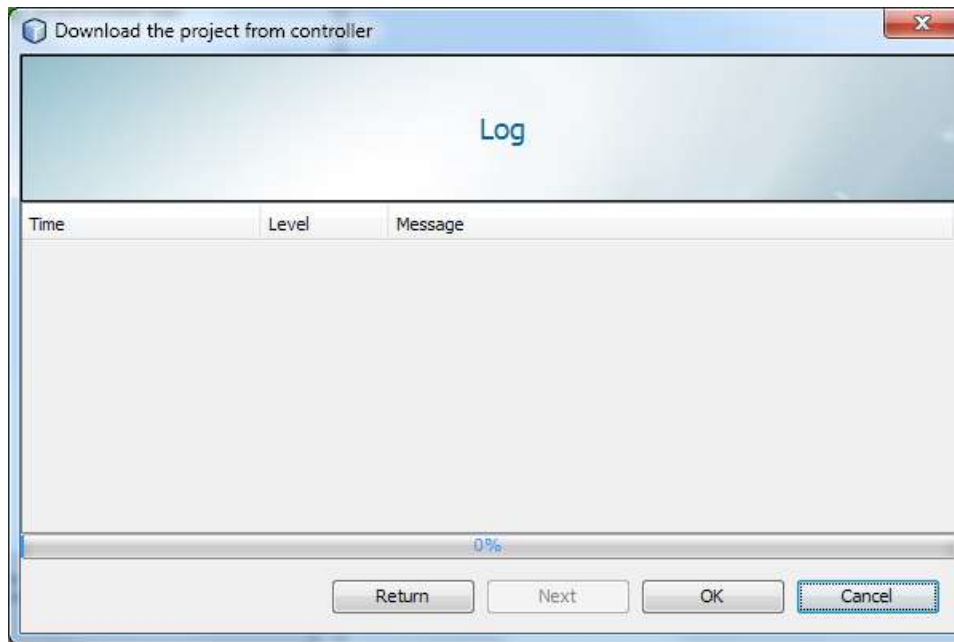

Figure 44 - Log page

In case of successful downloading you will see "Loading complete" in the right bottom corner of the application.

❗ Be advised that the graphical form of the algorithm reconstructed from the device setpoints reflect the logic of the algorithm, however the visual display representation may be different from the original one.

3.9 Functional block diagrams

See chapters 2.4 and 2.5.1 of this document to get information about implementation of function blocks and functional block diagrams in PLC Configurator.

3.9.1 Open workspace

To start creation of FBD you need to open FBD workspace. To do that, use double-click on workspace section of FB. Workspace will appear in the middle of the screen like shown in the figure below.

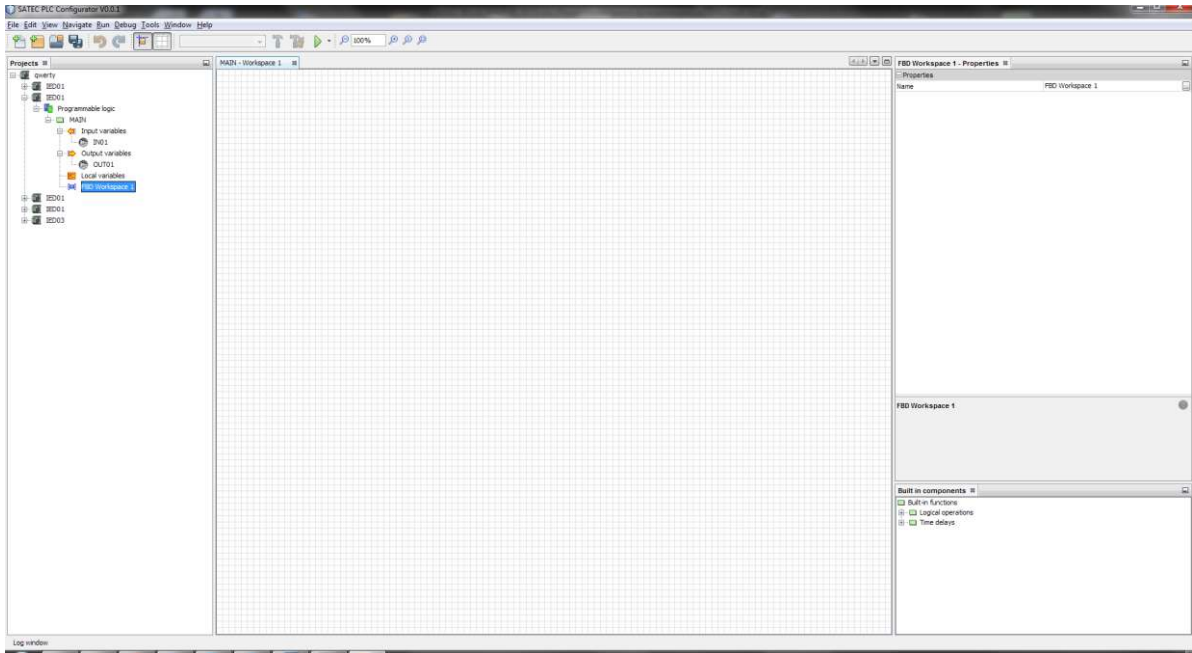

Figure 45 - Workspace

3.9.2 Add or delete variables

Before you start to add variables on the workspace, you should add them to the FB. To do that, see 3.7.2.

To add variable, just drag and drop it to the workspace.

In case of local variable you will get a menu where you need to choose its type (input, output or input/output variable) like shown in the figure below.

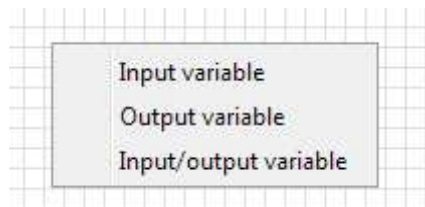

Figure 46 Type of a local variable

After adding, variables will appear on the workspace.

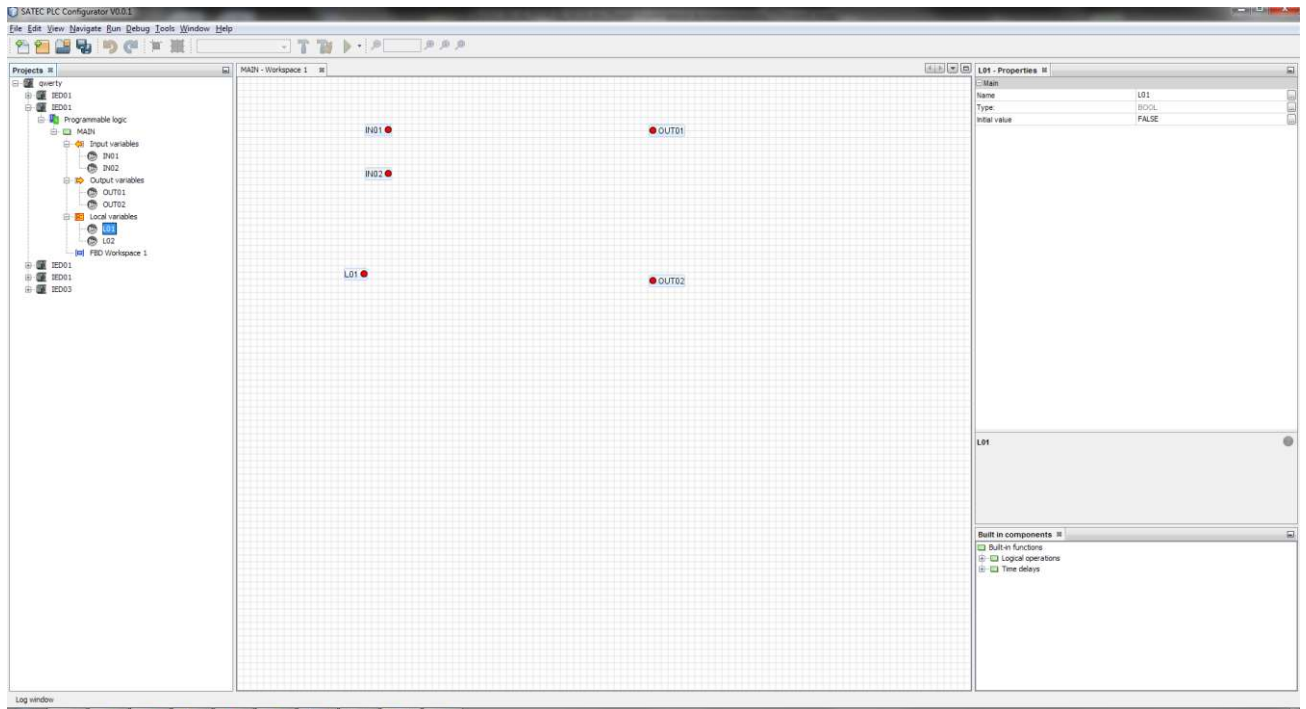

Figure 47 Workspace with variables

To delete variable click on it with the right mouse button and choose "Delete".

3.9.3 Variable properties

If you click on a variable that has been added to the workspace, its properties will appear in the Properties window. They consist of two parts, like shown in the figure below:

- Main properties.
- Interface variable properties.

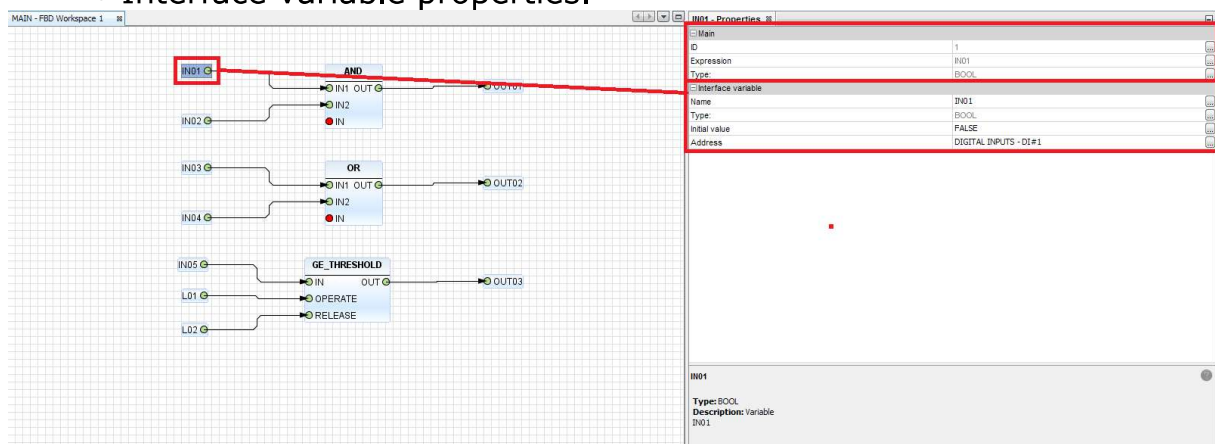

Interface variable properties provide users with the information about variable's initial value and address.

3.9.4 Add built-in components

To add built-in functions you need to expand type of function and drag and drop desired function to the workspace.

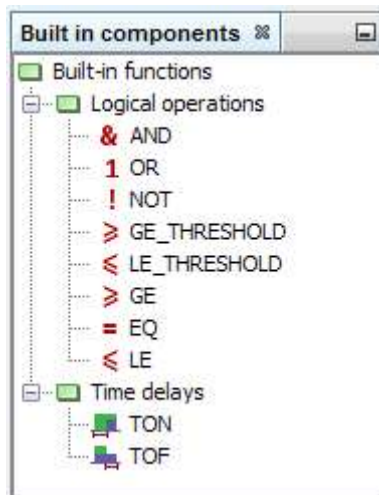

Figure 48 – Built-in components

After that, components will appear on the workspace.

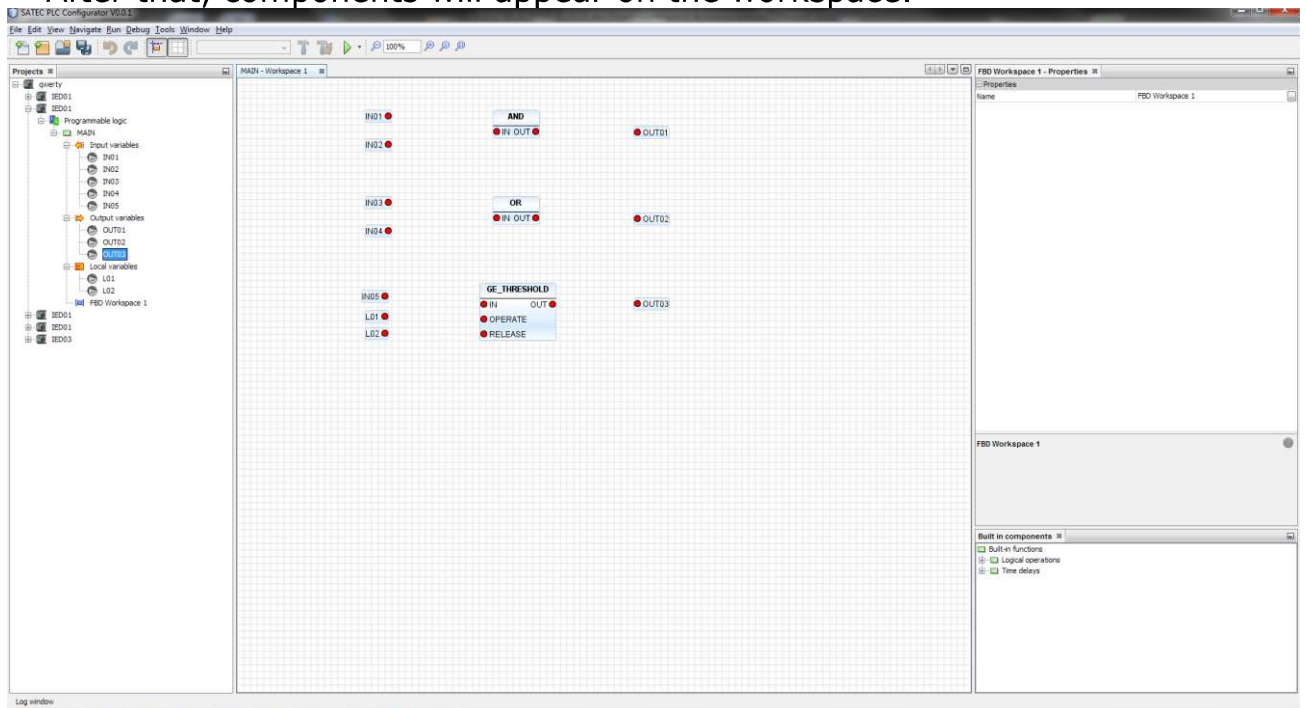

Figure 49 - Workspace with functions

3.9.5 Making connections

Variables and functions have pins – circles that are used for making connections. Red pins are not connected, green pins are connected. Input pins are placed on the left side an element, output pins are placed on the right side.

To make a connection between a variable and a function, click on an output pin and drag and drop to the desired input pin.

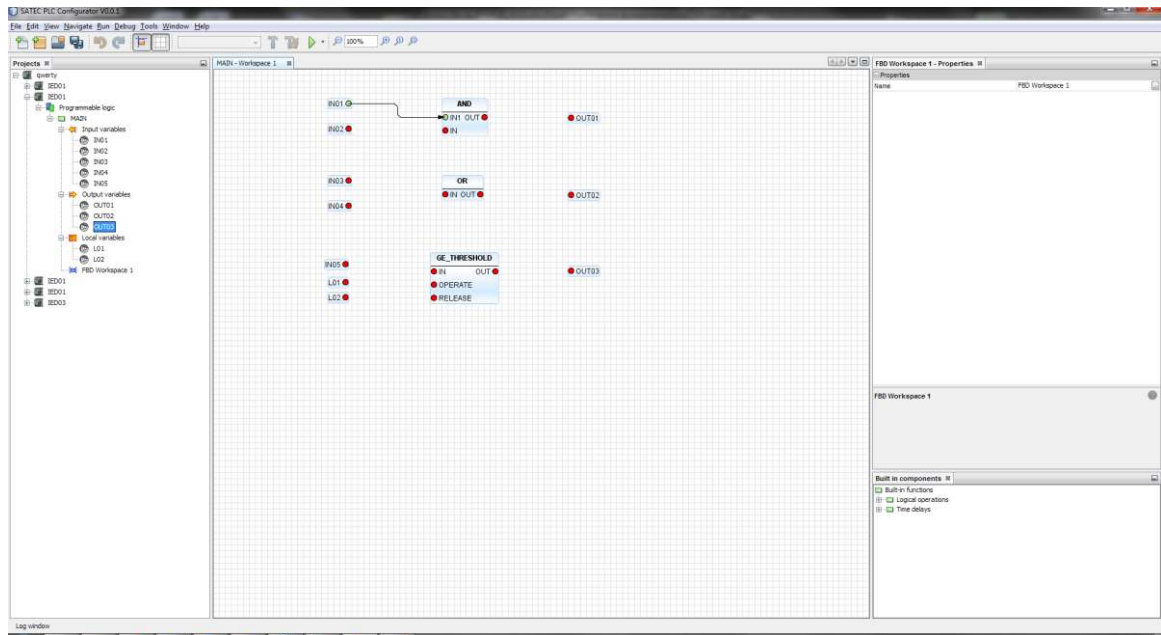

Figure 50 - Connections

If a connection is made the pin will change its color to green and pins will be linked with an arrow.

❗ Please note that some inputs can be multiple (for example in AND, OR functions). You can connect unlimited number of inputs there.

❗ Please note that the type of a variable and an input you want to connect with must be compatible. If they are not, you will not be able to make a connection between them. You can check type of a pin by pointing on it with a mouse cursor.

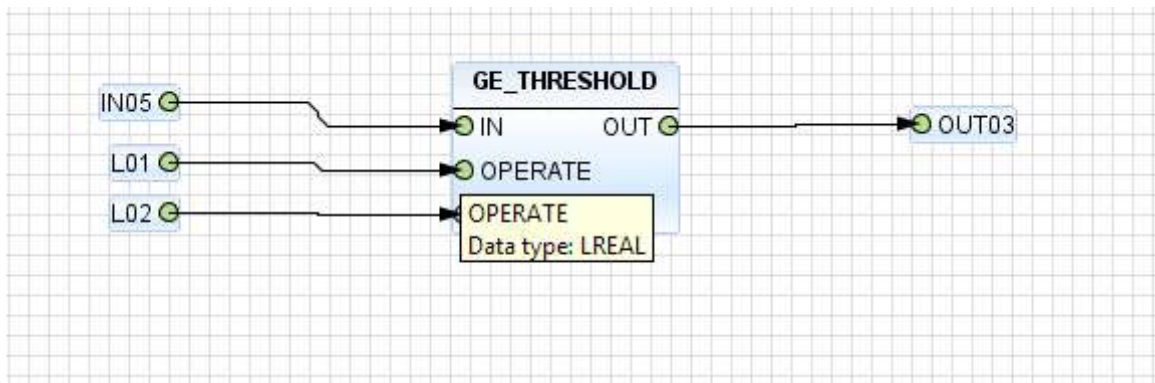

Figure 51 - Pin data type

To disconnect variable click on it with the right mouse button and choose "Disconnect".

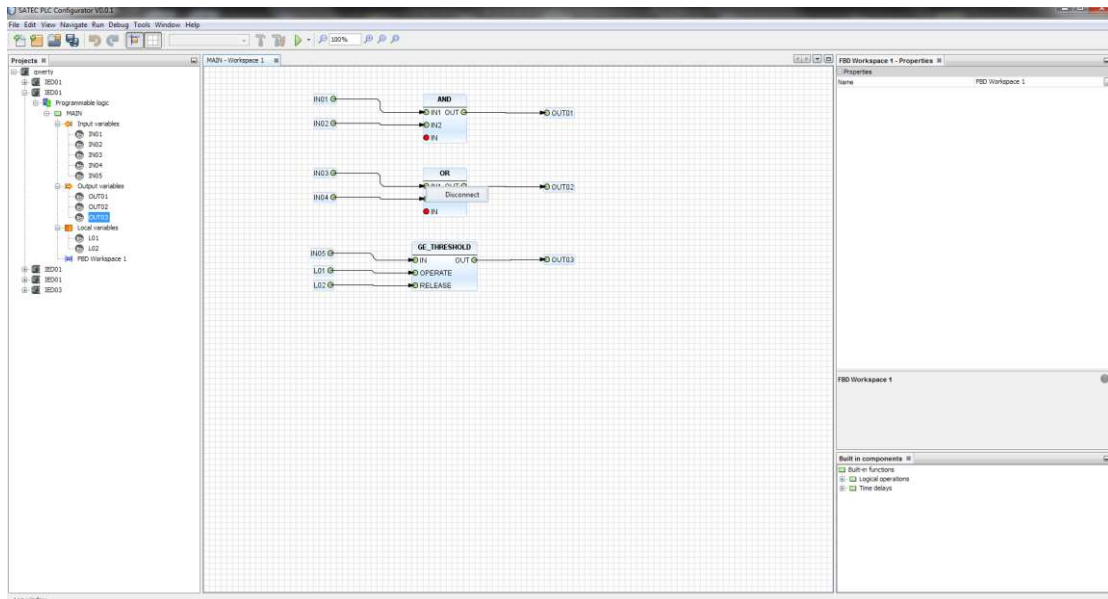

Figure 52 - Disconnect link

After making connections FBD is ready to be uploaded to the device. Just check that you have set addresses for all variables (see 3.7.3) and you can proceed to uploading the configuration to the PM180 device (see 3.8.2).

3.9.6 Making time delays

To make time delays use functions TON and TOF. For detailed information see 2.3.9 and 2.3.10. Time values are set via local variables with TIME data type.

Time delay example is shown in the figure below.

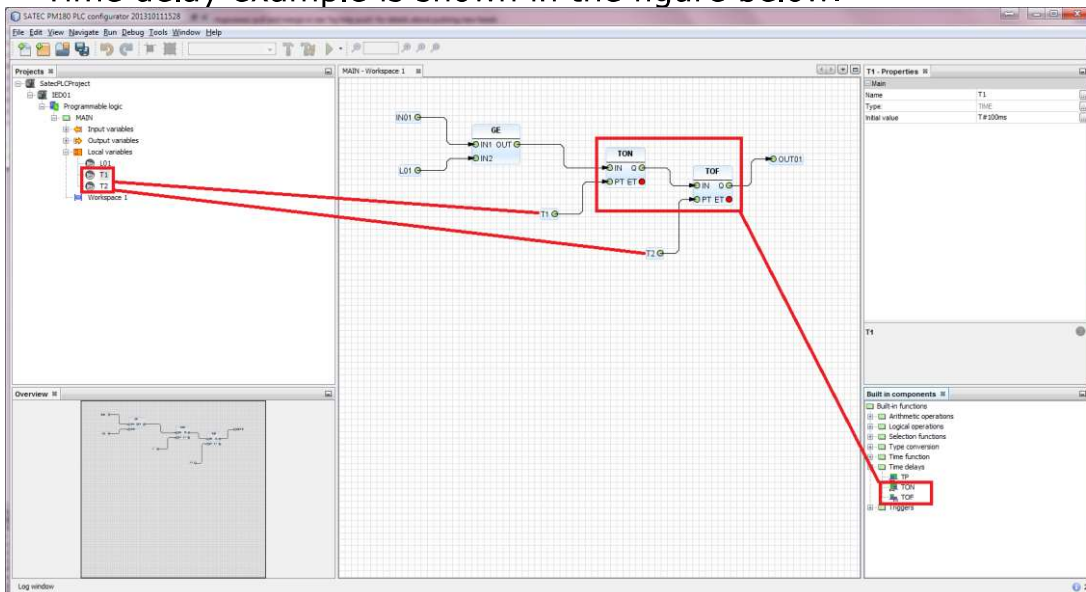

Figure 53 - Time delay

Time delay is set in Initial value property in one of these formats (in accordance with IEC 61131): "T#100ms", "T#200ms" or "T#1s0ms" (if a value is more than 1 second).

In the figure below you can see the result of this logic in PAS (after uploading to the device).

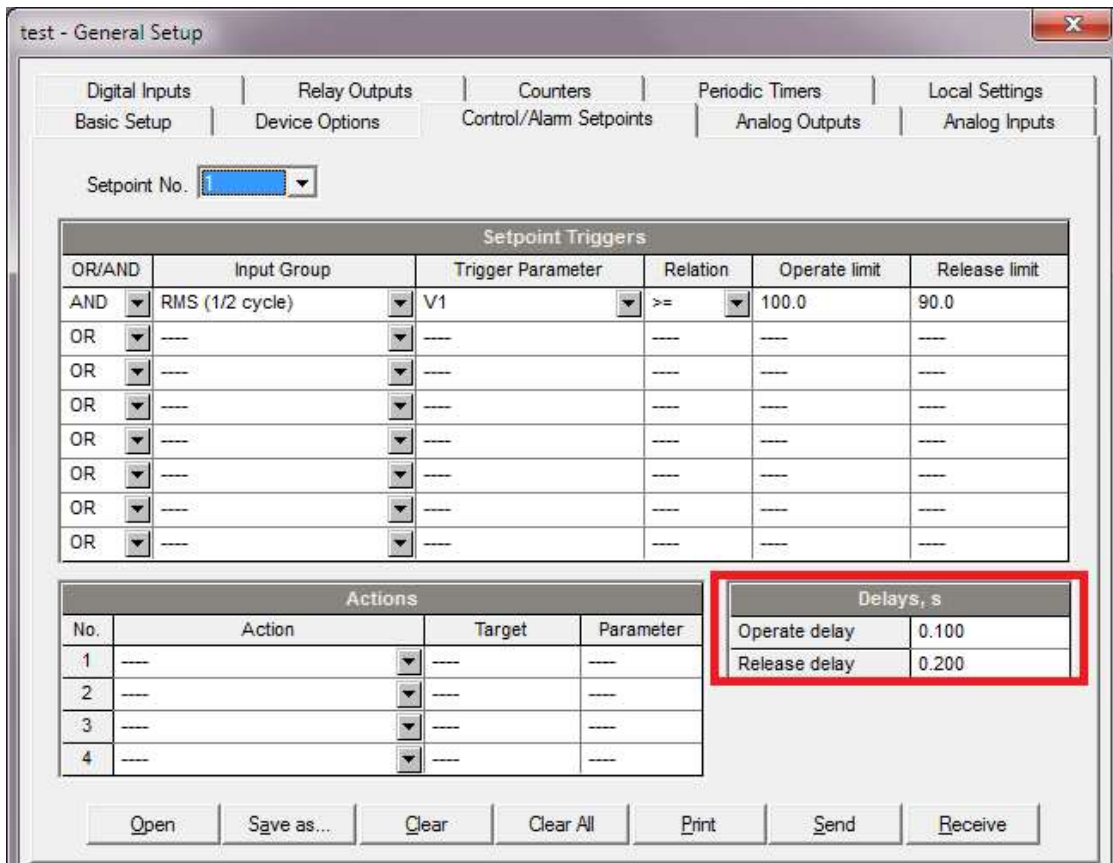

Figure 54 - Time delays in PAS

3.9.7 Programming limits for set point variables

There are two standard functions in IEC 61131 that are used for analog values comparisons: GE and LE. For detailed information about them see 2.3.4 and 2.3.6.

! Be advised that when you use comparison functions you are able to compare only variables with the same data type (see the figure below).

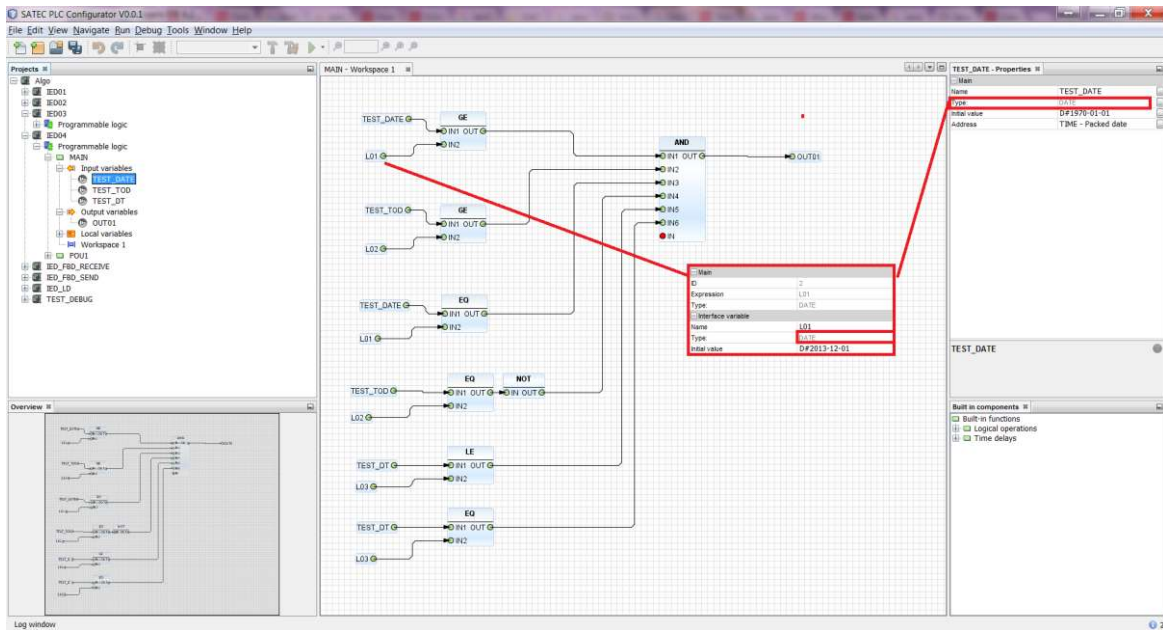

Figure 55 - Comparisons

Limits (particularly release coefficients) aren't supposed to be used with these functions. However the PM180 device claims setting these parameters. To do that, there is a "Release coefficient in comparison operations" property that you can set via Device properties (see 3.4). This coefficient has the value range from 0 (exclusively) to 1 (0,95 by default). When PLC Configurator compiles logic with GE or LE functions, it multiplies or divides to this coefficient to get operate or release limits. To set exact (not evaluated) operate or release limits for variables use functions `GE_THRESHOLD` and `LE_THRESHOLD`. For detailed information about these functions see 2.3.7 and 2.3.8. In this case limits that are set for these functions compile to operate and release limits directly.

In the figure below you can see an example of programming limits using threshold functions.

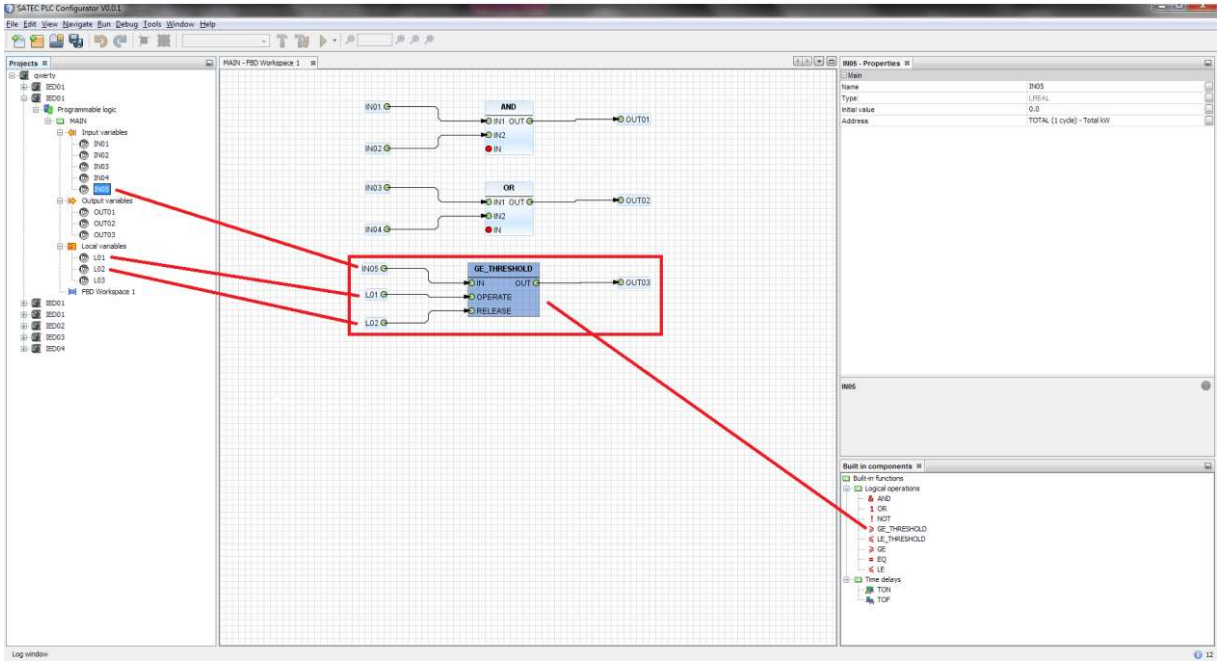

Figure 56 – Using GE_THRESHOLD

In this case limits are set using local variables L01 and L02, IN05 is a value input.

In the figure below you can see the result setpoint in PAS.

PM180_CAP_CONTROL_FUNCTION - General Setup

Digital Inputs | Relay Outputs | Counters | Periodic Timers | Local Settings

Basic Setup | Device Options | Control/Alarm Setpoints | Analog Outputs | Analog Inputs

Setpoint No. 10

Setpoint Triggers					
OR/AND	Input Group	Trigger Parameter	Relation	Operate limit	Release limit
AND	TOTAL (1 cycle)	kW	>=	1	2
OR	---	---	---	---	---
OR	---	---	---	---	---
OR	---	---	---	---	---
OR	---	---	---	---	---
OR	---	---	---	---	---
OR	---	---	---	---	---

Actions			
No.	Action	Target	Parameter
1	UNBLOCK RELAY	#1	---
2	---	---	---
3	---	---	---
4	---	---	---

Delays, s	
Operate delay	0.000
Release delay	0.000

Open | Save as... | Clear | Clear All | Print | Send | Receive

Figure 57 - Setpoint with limits

3.10 Ladder diagrams

See chapter 2.5.2 of this document to get basic information about implementation of ladder diagrams in PLC Configurator.

Basic concepts are similar to creating FBD. We suggest you to read chapter 3.9 first, then proceed to this chapter.

3.10.1 Add ladder diagram

To create a ladder diagram you need to add a device in your project and choose LD language in the window shown in the figure below.

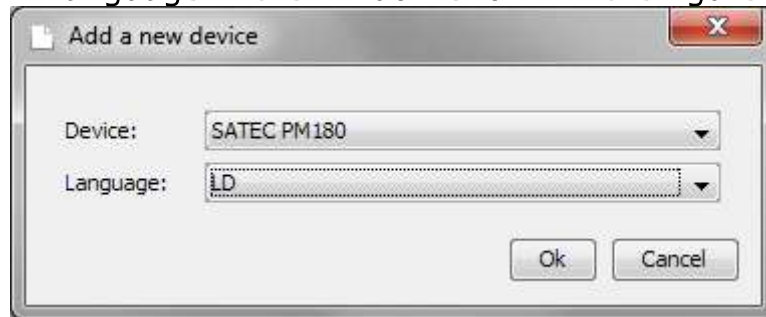

Figure 58 - Add new device with LD

If you want to add a ladder diagram to existing function block, just click with the right mouse button on the function block and choose "Add work area (LD)".

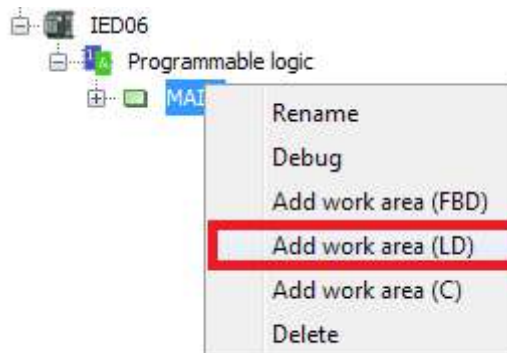

Figure 59 - Add work area (LD)

! You can use FBD and LD workspaces together in one function block and divide information between them if it is necessary.

After creating a workspace use double-click on it to open.

A ladder diagram consists of elements such as rails, contacts, coils. Also it can contain built-in functions (see 2.3).

All elements have pins. Pins can be attached or unattached. Attached pin are marked as green circle, unattached is marked as red circle.

To add any element to a ladder diagram (excluding rails) you need to drag-and-drop variable from variables list. Input, output and local variables are allowed.

3.10.2 Rails

There are two power rails: left rail and right rail. Left rail can be attached to any of variables excluding output variables and to any kind of coils. Right rail can be attached only to any kind of coils.

Multiple connections are allowed.

You cannot delete rails.



Figure 60 - Rails

3.10.3 Contact

Contact represents a normally open contact. It is closed whenever its coil or an input which controls it is energized. (Open contact at rest).

It has 2 pins:

- Input pin (left pin), that can be attached to left rail output, output variable, input-output variable, built-in function block contact or negated contact.
- Output pin (right pin) - can be attached to coil, built-in functions, contact, negated contact or right rail.

Multiple connections are allowed.

Contact can be created from any BOOL variable.

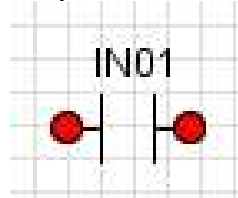

Figure 61 - Contact

3.10.4 Negated contact

Negated contact represents a normally closed ("not") contact. It is closed whenever its coil or an input which controls it is not energized. (Closed contact at rest)

It has 2 pins:

- Input pin (left pin) - can be attached to left rail output, output variable, input-output variable, built-in function block contact or negated contact.
- Output pin (right pin) - can be attached to coil, built-in functions, contact, negated contact or right rail.

Multiple connections are allowed.

Negated contact can be created from any BOOL variable

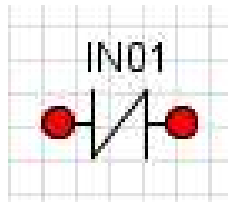

Figure 62 - Negated contact

3.10.5 Coil

Coil represents a normally inactive coil, energized whenever its rung is closed. (Inactive at rest)

It has 2 pins:

- Input pin (left pin) - can be attached to contact, negated contact, built-in function block, input variable, input-output variable.
- Output pin (right pin) – can be attached only to right rail.

Multiple connections are allowed.

Coil can be created only from an output variable or a local variable.

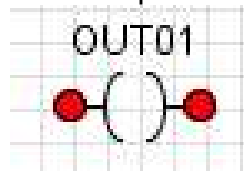

Figure 63 - Coil

3.10.6 Negated coil

Negated coil represents a normally active ("not") coil, energized whenever its rung is open. (Active at rest)

It has 2 pins:

- Input pin (left pin) - can be attached to contact, negated contact, built-in function block, input variable, input-output variable.
- Output pin (right pin) – can be attached only to right rail.

Multiple connections are allowed.

Negated coil can be created only from an output variable or a local variable.

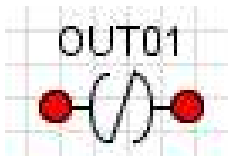

Figure 64 - Negated coil

3.10.7 Creating LD

Let's create a simple ladder diagram that contains several contacts and coils.

To create a contact you need to drag-and-drop a variable to the workspace.

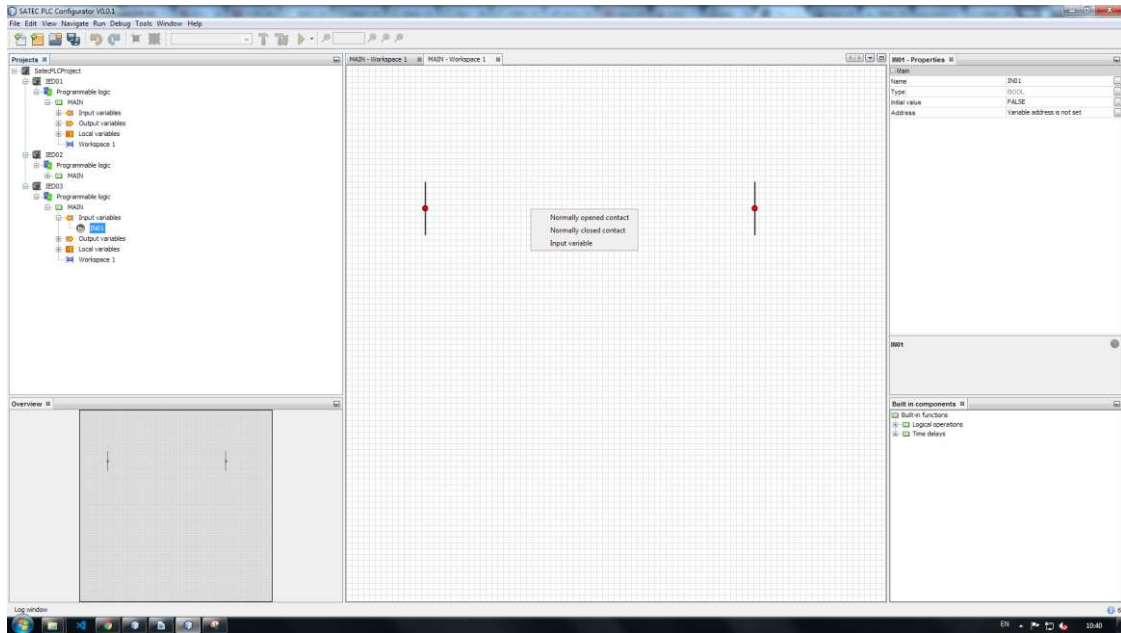

Figure 65 - Add contact

On the appeared menu choose type of the contact, for example "Normally opened contact".

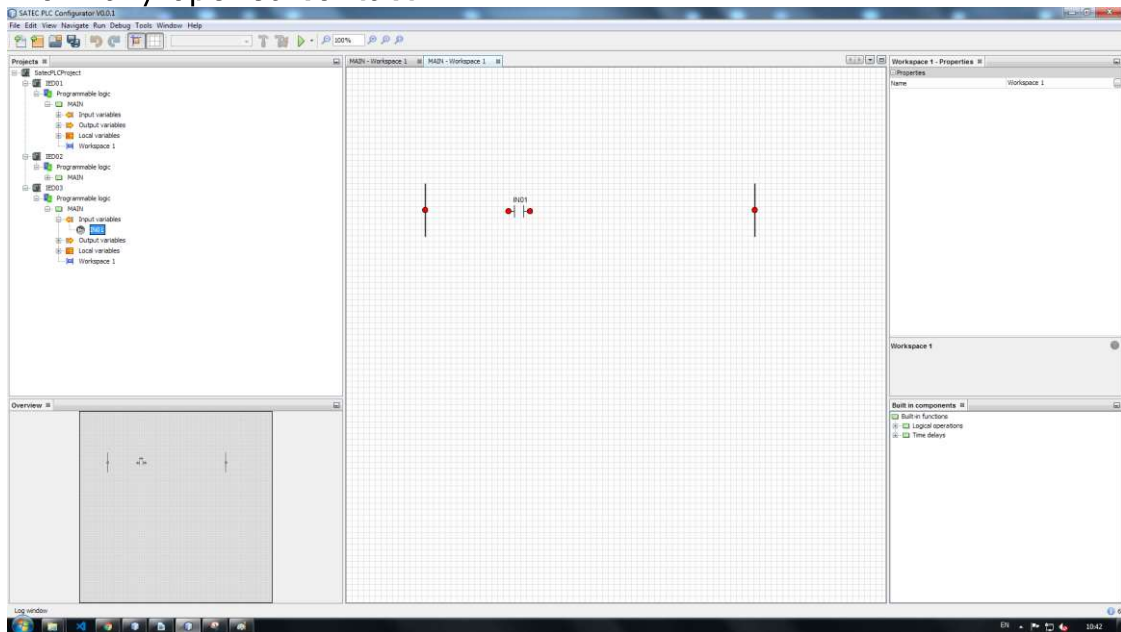

Figure 66 – A contact on LD

A contact will be added to a ladder diagram and it will be assigned to the variable you chose.

Similarly you can add a coil. Just drag and drop an output variable to the workspace and choose type of the coil you want to add. A coil will be added to your ladder diagram.

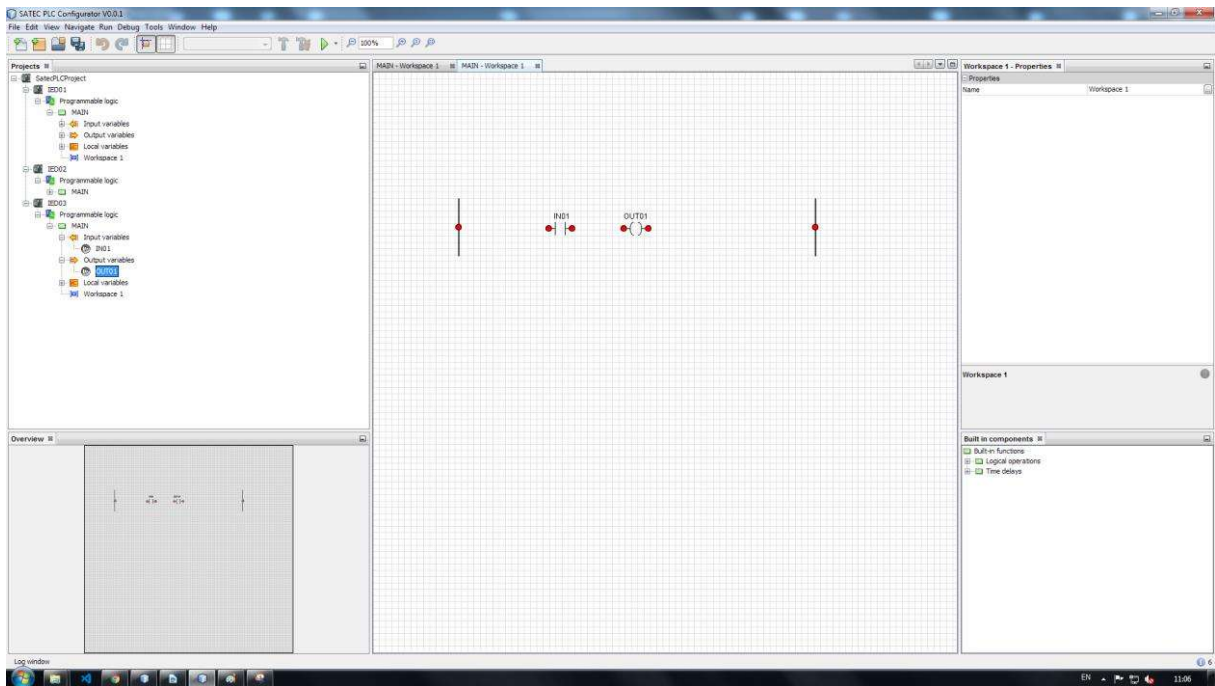

Figure 67 - A contact and a coil on LD

Now let's connect the elements.

To do that, you need to click on the right pin of any element and drag an arrow from the pin.

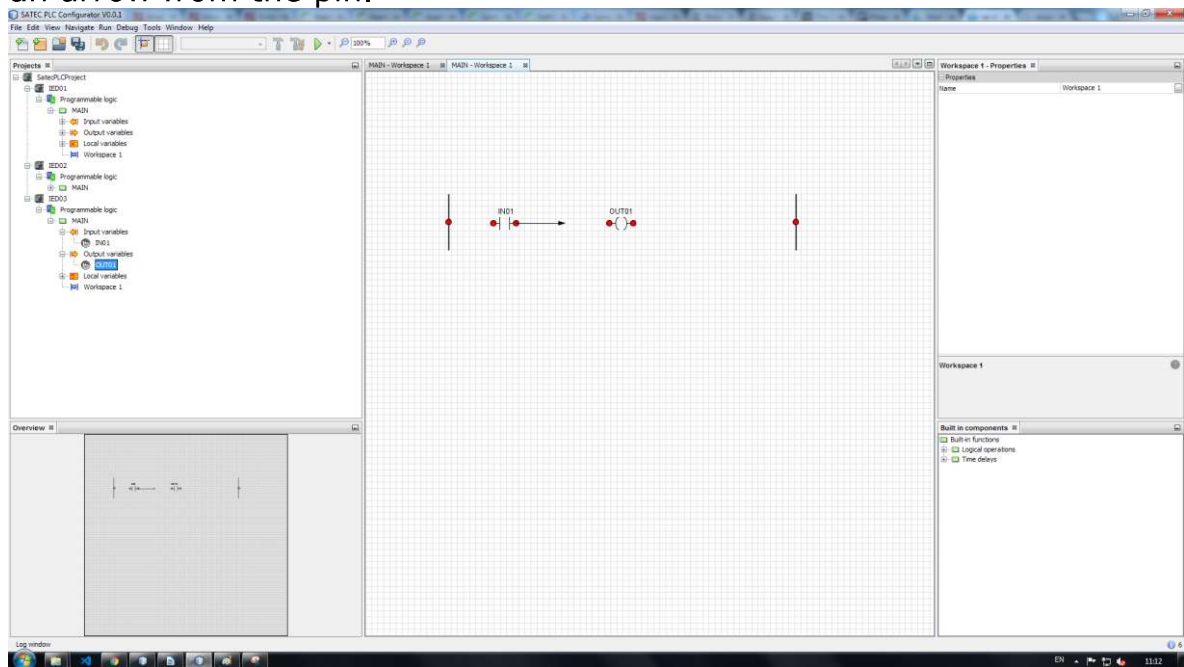

Figure 68 - Making connections

Then, drag the arrow to any valid pin, for example, left coil pin. Now the elements are connected.

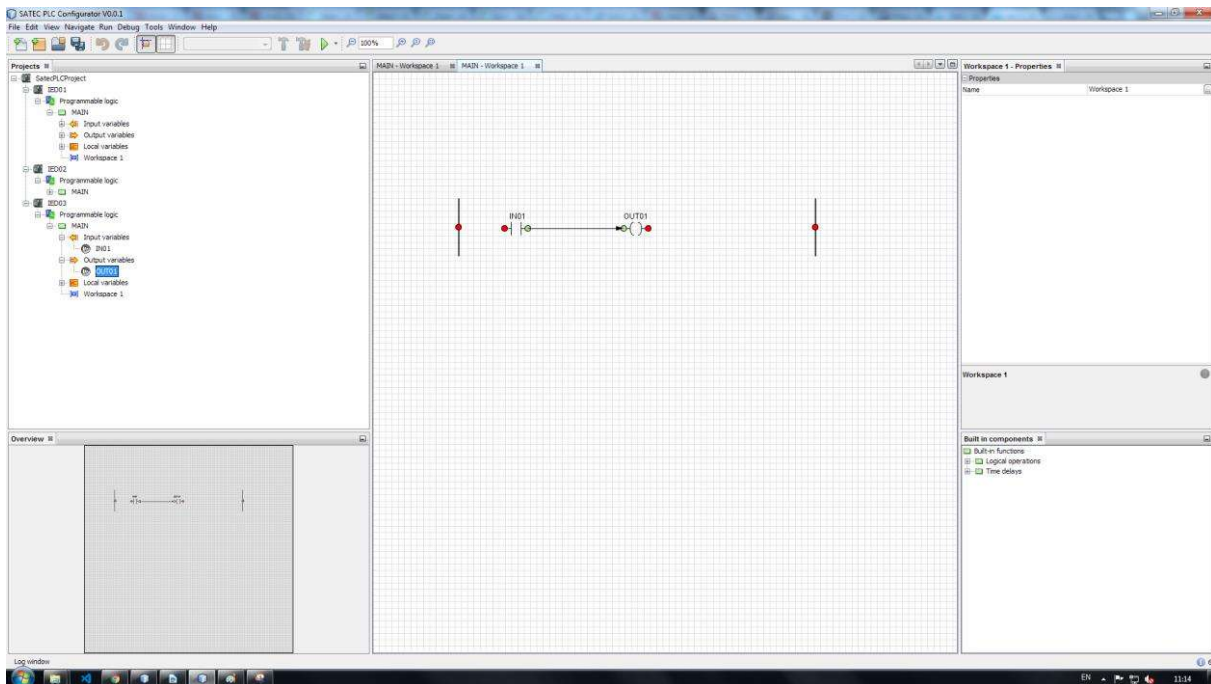

Figure 69 - Connection made

Let's finish our rung by connecting other elements.

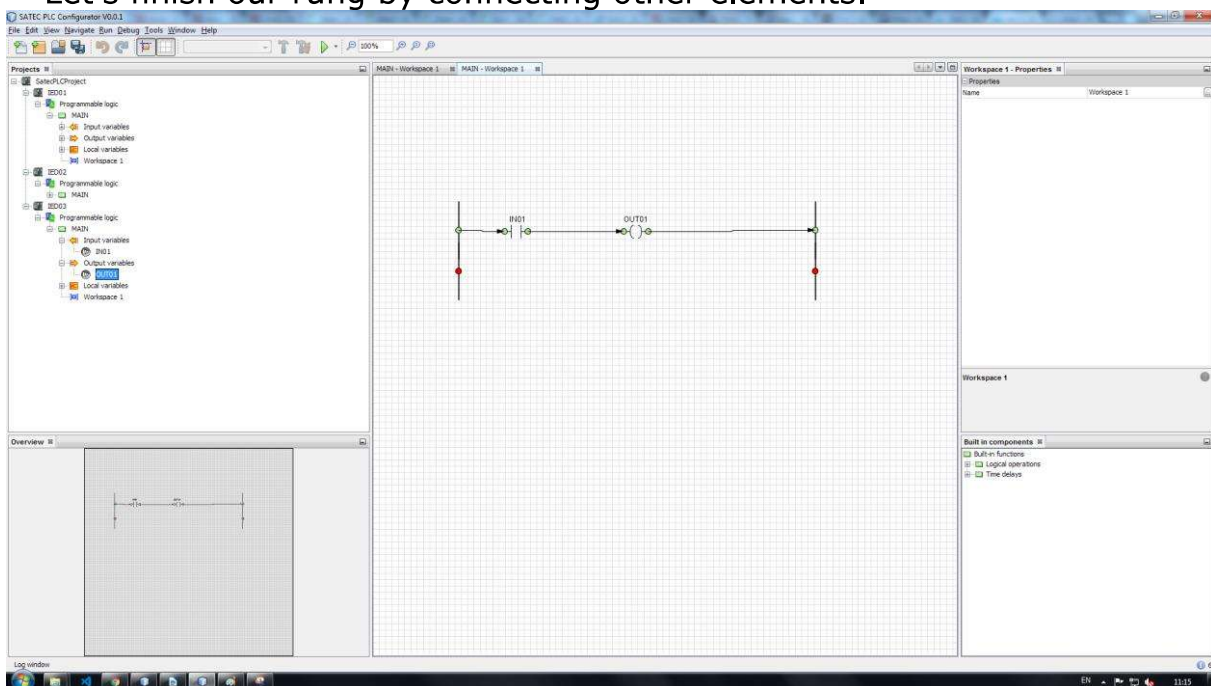

Figure 70 - A complete rung

Now you can see that when you add more links between rails, the quantity of pins is being incremented. You are able to make as many rungs as you like.

! Please note that before uploading the configuration to the PM180 device you need to set addresses for all input and output variables. To do that, see 3.7.3.

After that your ladder diagram is ready to be uploaded to the device. To do that, see 3.8.2.

3.10.8 Transformation LD into setpoints

After uploading you can check the uploaded setpoints in PAS. In the figure below you can see how a ladder diagram transforms in setpoints that the PM180 device can use.

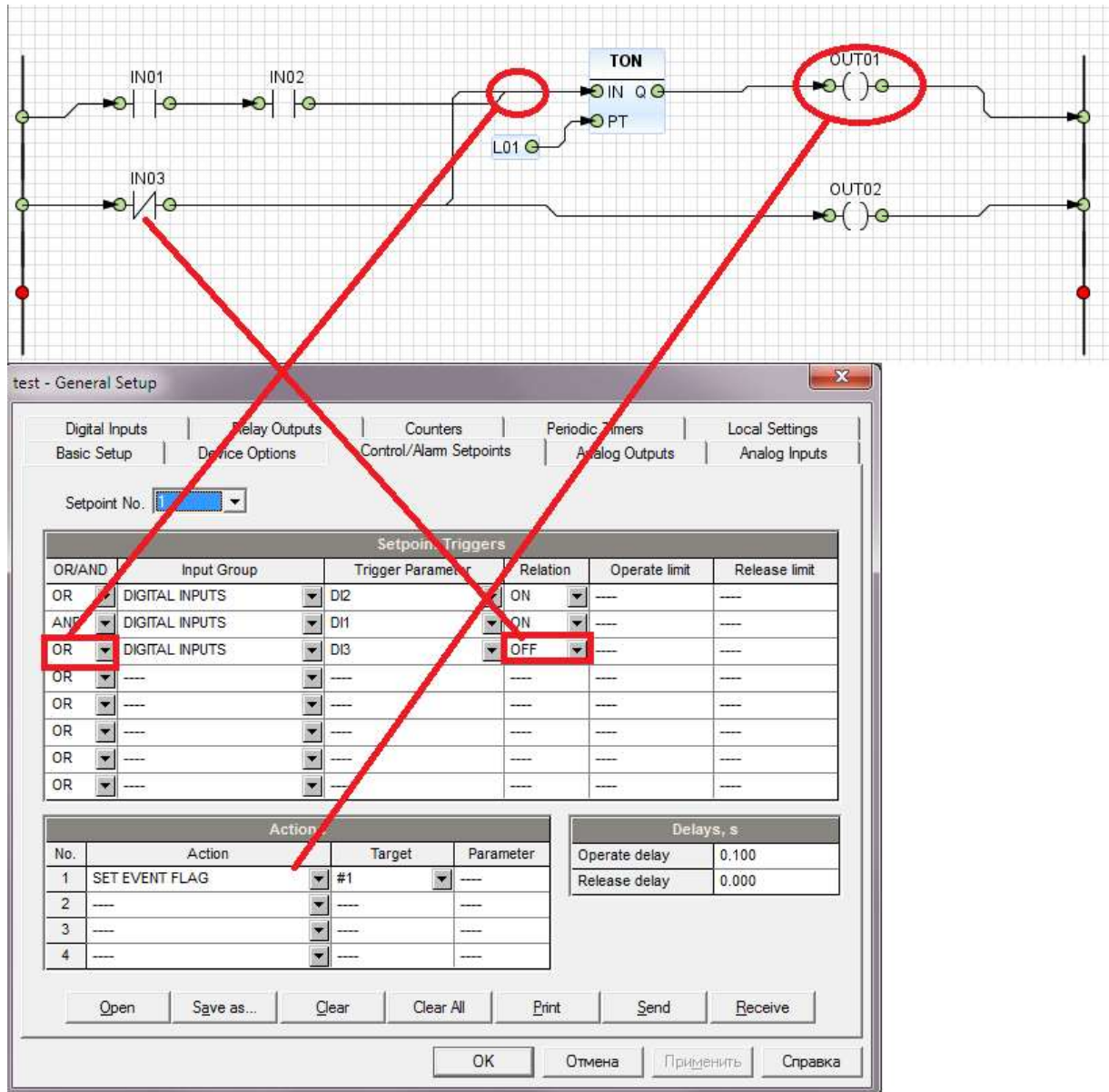

Figure 71 - LD logic in PAS

3.11 Using PLC Configurator with PAS

⚠ PLC Configurator is only used for setpoints configuration and PAS should be used for other configuration needs.

To create logic on the PM180 devices you can use PLC Configurator together with PAS. Some set points can be set via PLC Configurator and some of them can be set via PAS.

PLC Configurator has a special logic generator which automatically distributes logic among set points in accordance with a special property "Settings range for the logic generator" (see 3.4). To set which set points will be used in this distribution you need to set this property. By default PLC Configurator uses all set points (1-64). You can set this range using "-" and "," symbols like shown in the figure below.

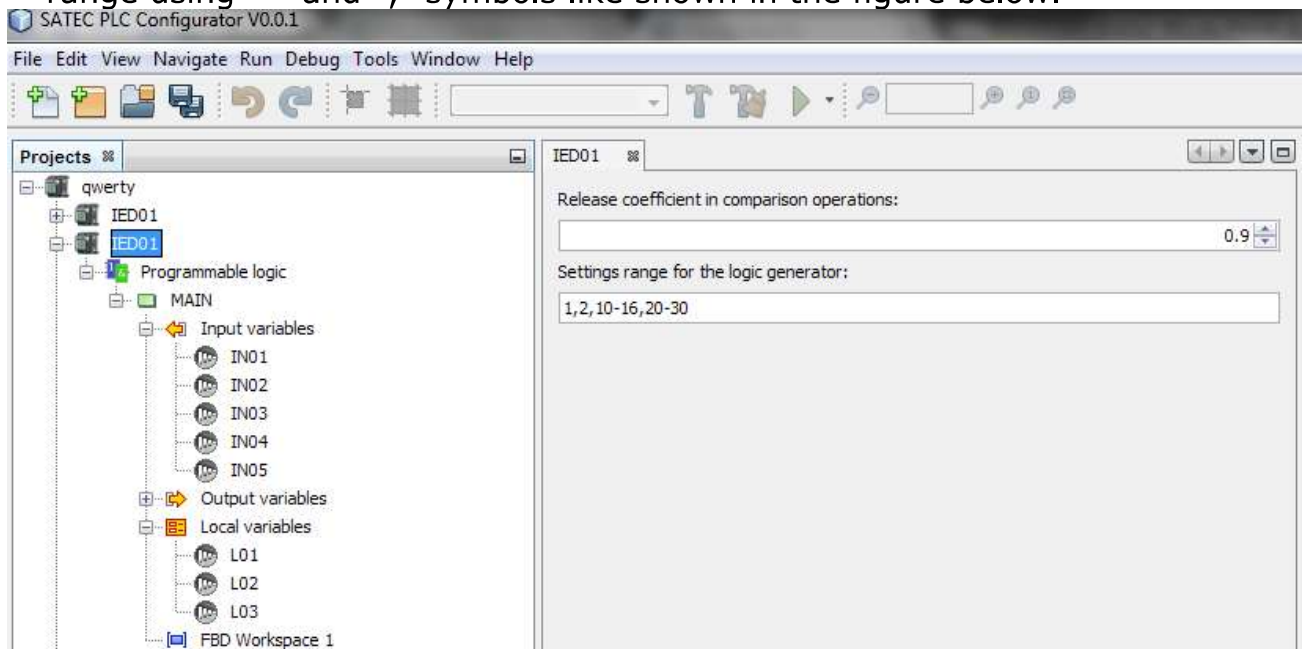

Figure 72 - Settings range

In this case PLC Configurator will be using the first, second set point and set points between 10 and 16 and between 20 and 30. Other set points can be programmed via PAS application.

4 Troubleshooting

4.1 Address in not set

If you linked a variable on a diagram but didn't set its address you will get a message like in the figure below.

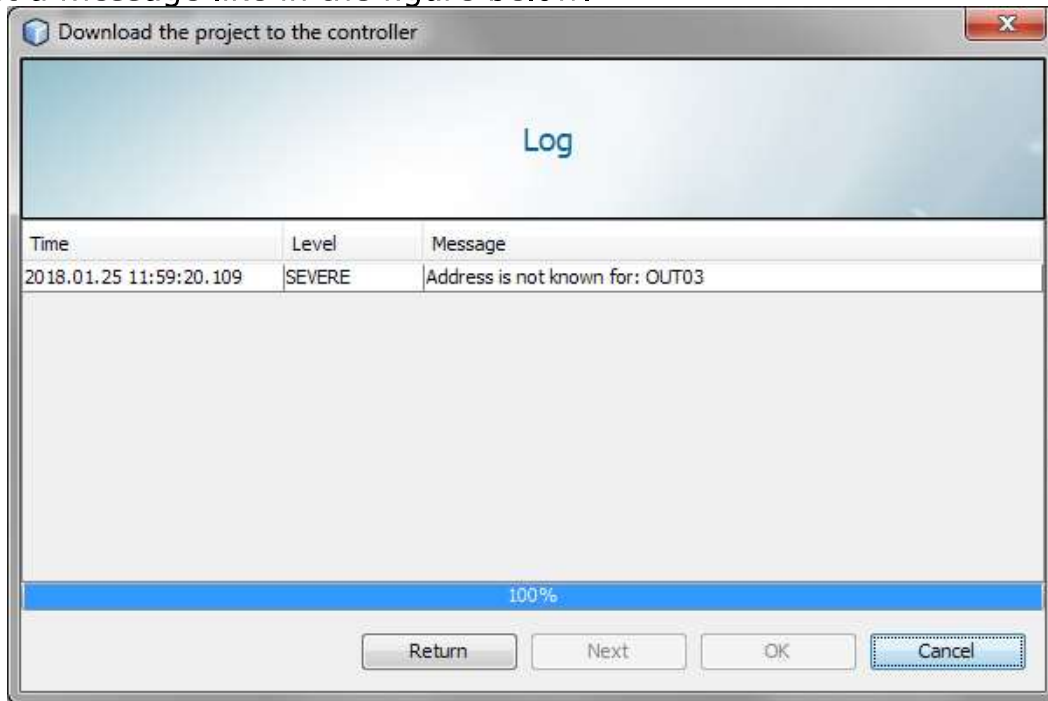

Figure 73 - Unknown address

In this case you need to set variables address. To do that, see 3.7.3.

4.2 Connection error

If you have a connection error during uploading or downloading a configuration you will get a message like shown in the figure below.

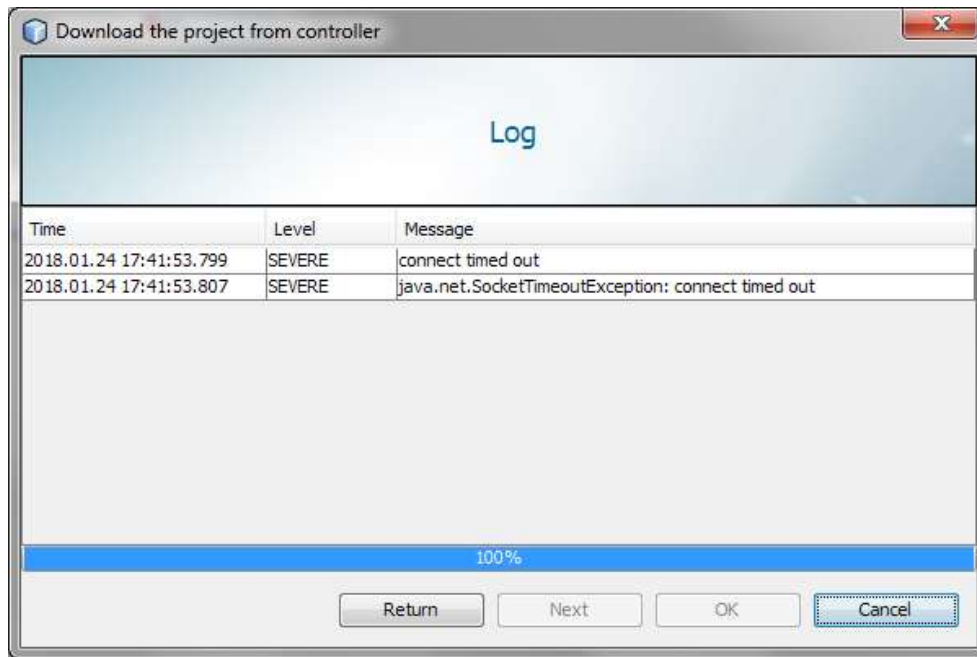

Figure 74 - Connection error

To fix this you need to press Return and check the communication interface and connection settings.

You can get proper settings by connecting to the device using PAS software.

4.3 No MAIN module

“No MAIN module” error appears during building project before uploading configuration to the device (when you use function “Send configuration to the device”).

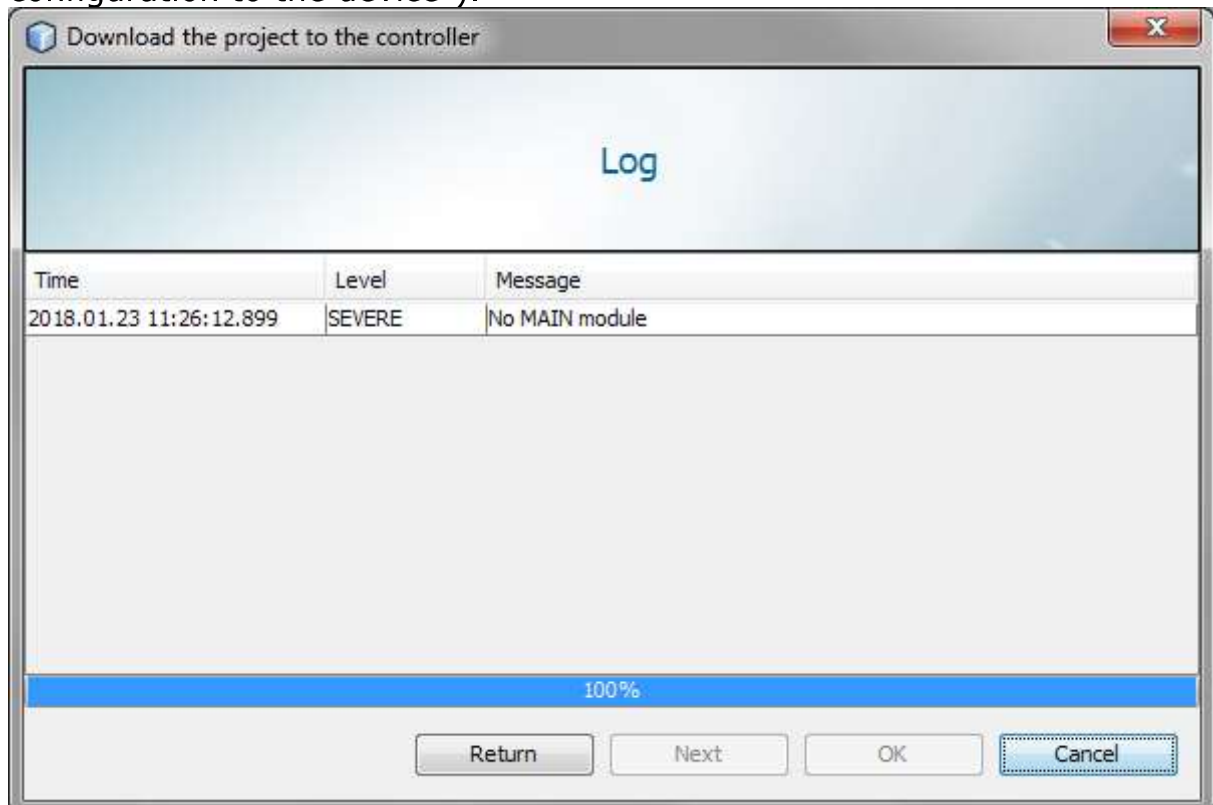

In this case you should rename one of the function blocks that are in the device project or add new function block and set name "MAIN" to it.

4.4 Unconnected inputs

If you get a message like in the figure below, you should check your FBD for unconnected pins (they are marked as red circles).

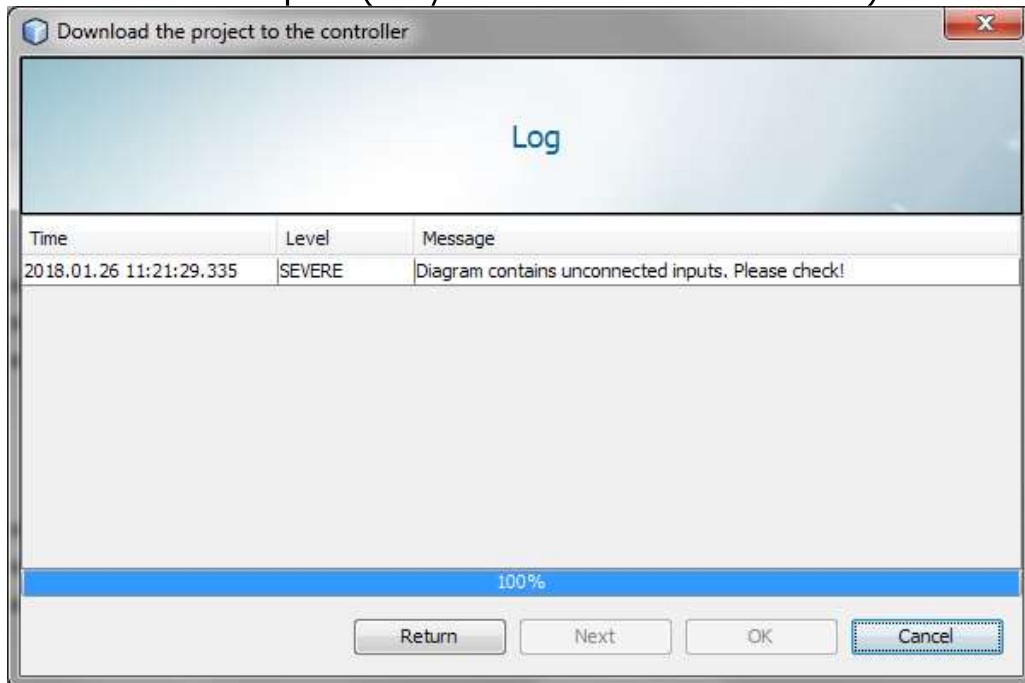

Figure 75 – Unconnected inputs error

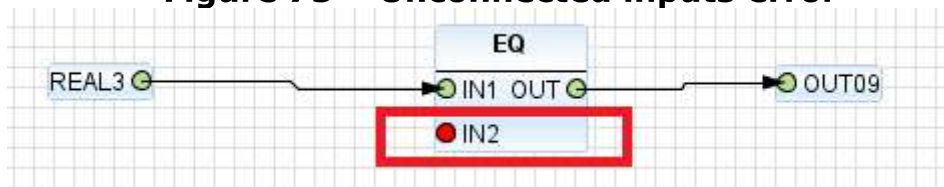

Figure 76 - Unconnected input